



YANMAR

USER OPERATION AND
MAINTENANCE MANUAL

MINI EXCAVATOR

SV26

Original manual



YANMAR CONSTRUCTION EQUIPMENT EUROPE S.A.S. THANK YOU FOR PURCHASING A YANMAR MACHINE

Read this manual carefully to find out how to use and maintain your machine correctly.

If the safety rules are not respected, injury may be caused or the equipment may be damaged.

This manual must be considered as a permanent part of your machine and must not be separated from the machine when you sell it.

This machine has been designed metrically. The measurements contained in this manual are also metric.

Only use metric equipment and tools.

The right and left hand sides are determined by facing the forward movement direction.

The warranty is a part of the YANMAR product support programme for customers who use and maintain their equipment as described in this manual. If the equipment has been used incorrectly or modifications have been made to transform its performances beyond the original factory specifications, the warranty expires and the improvements on site under warranty are rejected. The use of fuel beyond the specifications required or boosting the machines' engines will cancel the warranty.

All the information, illustrations and specifications contained in this manual are based on the latest product information available on publication. YANMAR reserves the right to modify the information and illustrations in this manual without notice. For any further information, please contact your approved YANMAR dealer.

The images that appear in this booklet are provided for information purposes and may vary according to each model.

WARNING

Never try to run or use this machine without having read and understood all the applicable security messages contained in this manual.

Injury may be caused if the safety messages are not respected.

To ensure that this manual remains available for other users, always put it back in its compartment when it is not being used.





DECLARATION OF CONFORMITY

The undersigned YANMAR C.E. Europe SAS, 25 rue de la Tambourine, 52115 ST-Dizier FRANCE states that the designated machine:

Description - Generic name - Function - Model - Type - Serial number - Trade name

SV26XX – SV26 – MINI-EXCAVATORS – SV26 – SV – XXXXXXXXX – SV26

Special equipment:

- XXXX
- XXXX

* complies with the provisions of the following European directives and the national legislations implementing them.

- 2006/42 CE
- 2004/108 CE
- 97/68 CE
- 2004/26 CE
- 2000/14 CE + 2005/88 CE

Procedures applied for conformity assessment are: NF EN ISO 3744;
NF ISO 6395

produced by: CETIM centre technique des Industries Mécaniques
52, avenue Félix Louat – BP 80067 – 60304 SENLIS
Cedex FRANCE

Net power output: 17,6 kW * 2400 rpm

Measured sound pressure	92,7 dBA
Guaranteed sound pressure	94 dBA

* Name and address of the person established in the European community, authorized to compile the technical file and transmit it in whole or part to the public authorities in response to a reasonable request:

Jean Marc REYNAUD, Directeur Général, YANMAR C.E. Europe SAS – 25, rue de la Tambourine 52115 SAINT DIZIER
CEDEX –FRANCE

* The following documents were used in the design of the machine:

- Harmonised standards:

EN 474-1; EN 474-5;

Done at Saint-Dizier, the

XX/XX/XXXX

Jean-Marc REYNAUD, Directeur Général





REFERENCE INFORMATION

Note information about your YANMAR machine here.

Always use these references for everything to do with your YANMAR machine.

Model name :	
Machine serial number :	
Serial number of the engine :	
Your YANMAR dealer :	
Address :	
Telephone :	





INTRODUCTION

This User and Maintenance Manual has been designed to provide you with important information and the suggestions you need for safe and effective use of the machine. Read the manual before you use the machine to familiarise yourself with the operation, verification and maintenance procedures and instructions. A serious accident may be caused if you do not respect the precautions contained in this user manual or use any procedures that are not recommended.

DANGER

Incorrect use of the machine may cause serious injury or even death. Personnel involved in using and maintaining the machine must familiarise themselves with the content of this manual before carrying out a task.

- Do not start the machine before you have familiarised yourself with the content of this manual.
- The personnel responsible for using the machine must keep this manual within easy reach and consult it from time to time.
- If you lose or damage the manual, order a new one immediately from your dealer.
- When you sell the machine to another user, do not forget to pass on the manual at the same time.
- YANMAR provides its customers with products that conform to the regulations and industrial standards that apply in their respective countries. If you are using a YANMAR machine that you have bought from a foreign company, you should be aware that certain safety mechanisms may be missing from the machine. Consult your dealer to find out whether your machine complies with the regulations and industrial standards that apply in your country.
- Some of the machine's specifications may differ from those described in the manual because the machine's design and performances have been improved. If you have any comments to make concerning the content of the manual, do not hesitate to consult your dealer.
- The important safety instructions are presented in this manual in sections:
 -  **1 Basic precautions, page 59**
 -  **2 Usage precautions, page 63**

Consult these pages and respect these safety instructions before starting up the machine.

- In this manual, the main product sections are designated as follows :

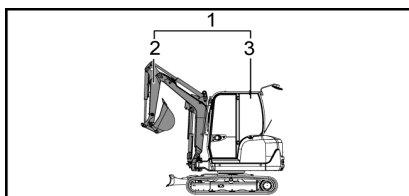





- (1) **Machine** = whole product
- (2) **Equipment** = part including the arm, the boom, the bucket or any other accessory
- (3) **Basic machine** = part comprising the upper structure and the lower frame





SAFETY SIGNALS

The following signals are used in this manual to indicate the severity of the risks that may be encountered if the warnings concerning the product are not respected :

 DANGER	Dangerous situation imminent that may cause death or serious injury.
 WARNING	Potentially dangerous situation likely to cause death or serious injury.
 CAUTION	Potentially dangerous situation likely to cause slight or medium-seriousness injury .
 IMPORTANT	Remarks or instructions to be respected to ensure the completely safe operation and maintenance of the machine.

 **WARNING**

The operator of this machine must be competent and trained in its use.

 **WARNING**

Never try to operate or repair the machine if you have not read and understood all the applicable warnings and usage instructions contained in this manual and on the safety signals on this machine. Physical injury may be caused if the safety instructions are not respected.

 **WARNING**

Never modify the design of the machine or its engine.

Never remove or deactivate the protections or safety mechanisms installed.

Any unauthorised modification to the design or use of unauthorised accessories may cause physical damage.

In addition, in that these actions would constitute an explicit violation of the terms of the YANMAR Product Warranty, the applicable warranty would also become null and void.



TABLE OF CONTENT

A	Description and illustration of the machine.....	1
1	Applications and regulations.....	3
1.1	Applications.....	3
1.2	Warranty.....	3
1.3	Driving permits.....	3
1.4	Lifting.....	3
2	Identification plates.....	4
2.1	Machine serial number plate.....	4
2.2	Engine serial number plate.....	4
2.3	EPA information plate.....	4
2.4	Spare parts order and intervention request.....	5
3	Warning labels.....	6
3.1	Location of the warning adhesive labels.....	7
3.2	Explanation of the warning adhesive labels.....	9
4	Identification of important parts.....	12
4.1	General view of the machine.....	12
4.2	Commands and switches.....	13
5	Description of the driving position.....	14
5.1	Operator display station.....	14
5.1.1	Indicator lights.....	14
5.1.2	Diesel gauge.....	16
5.1.3	Cooling fluid temperature indicator.....	16
5.1.4	Time counter.....	16
5.1.5	Navigation keys.....	17
5.1.6	Information and error icons.....	17
5.2	Switches.....	18
5.2.1	Start key.....	18
5.2.2	Headlight switch.....	19
5.2.3	Cigar lighter.....	19
5.2.4	Horn.....	20
5.2.5	Windscreen wiper switch and windscreen wiper.....	20
5.2.6	Ventilation switch.....	20
5.2.7	Interior lighting switch.....	21
5.2.8	Boom rotation selection switch / PTO 1.....	21
5.2.9	2nd gear switch.....	21
5.3	Joysticks and pedals.....	22
5.3.1	Locking lever.....	23
5.3.2	Right command lever.....	23
5.3.3	3rd hydraulic circuit control (P.T.O. 1).....	24
5.3.4	Left command lever.....	24
5.3.5	Travel levers and pedals.....	25
5.3.6	Blade lever.....	27
5.4	Power socket.....	27
5.5	Driver's seat.....	27
5.6	Location for the tools and user manual.....	28
5.6.1	Toolkit.....	28
5.6.2	User manual.....	28
5.7	Fuses.....	29
5.7.1	Fusebox.....	30



5.8	Ash tray.....	31
5.9	Cabin.....	32
5.9.1	Cab side door.....	32
5.9.2	Upper windscreen.....	33
5.9.3	Right hand cab window.....	34
5.10	Headlights.....	35
6	Heating valve.....	36
7	Options.....	37
7.1	Long arm.....	37
7.2	3rd hydraulic circuit.....	37
7.3	PTO line 2.....	38
7.4	Automatic engine idle.....	39
7.5	Additional counterweights.....	40
7.6	Lifting Kit.....	40
7.6.1	Lifting ring.....	41
7.6.2	Safety valves.....	41
7.6.3	Overload box.....	41
7.6.4	Lifting Tables.....	42
7.7	Movement alarm.....	42
7.8	Protection of cylinder.....	42
7.9	Plug-in flashing light.....	42
7.10	Keypad immobilizer.....	43
7.11	The immobilizer key is coded.....	44
7.12	Anti-starter with key.....	44
7.13	Fleet management system MTECH.....	44
7.14	Bio oil.....	45
7.15	Radio.....	46
7.16	Quick coupler.....	46
7.17	Centralized greasing system.....	46
7.18	Mechanical quick coupler.....	48
7.18.1	Mechanical quick coupler ARDEN EQUIPMENT	49
7.18.2	Mechanical quick coupler RETROMATIC MORIN	50
7.18.3	Mechanical quick coupler CSERI	51
7.19	Quick hydraulic attachment CSERI.....	52
7.19.1	Dismantling the accessory.....	53
7.19.2	Mounting the accessory.....	53
8	Covers.....	55
8.1	Bonnet.....	55
8.2	Cover B.....	56
8.3	Circuit breaker.....	56
B	Operating instructions.....	57
1	Basic precautions.....	59
1.1	Comply with your workplace's safety rules.....	59
1.2	Put the safety mechanisms in place.....	59
1.3	Wear suitable clothing and protective equipment.....	59
1.4	Do not drive under the influence of alcohol, drugs or medication.....	60
1.5	Provide adequate ventilation when working in an enclosed space.....	60
1.6	Protect plants from hot air and exhaust fumes.....	60
1.7	Keep fuel and oil away from sparks.....	60
1.8	Avoid removing the caps when the temperatures are high.....	61



1.9	Have an extinguisher and a first aid kit.....	61
1.10	Avoid any unauthorised modifications.....	61
1.11	Precautions for optional parts and tools.....	62
1.12	Warning concerning the cab windows.....	62
1.13	Cabin's emergency exit.....	62
2	Usage precautions.....	63
2.1	Precautions before starting the engine.....	63
2.1.1	Make sure that your workplace is safe.....	63
2.1.2	Clean the machine.....	63
2.1.3	Check the safety structures.....	64
2.1.4	Check the position of the blade.....	65
2.1.5	Accessing the machine.....	65
2.1.6	Fasten your safety belt and adjust the rearview mirror(s).....	66
2.2	Movement precautions.....	66
2.2.1	Machine's Danger Zone.....	66
2.2.2	Movement and accessories.....	67
2.2.3	Driving the machine on a slope.....	67
2.3	Working precautions.....	69
2.3.1	Precautions for using the equipment.....	69
2.3.2	Dangerous tasks.....	71
2.3.3	Working near electricity lines.....	72
2.3.4	Working near obstacles.....	72
2.3.5	Emergency stop and securing the machine.....	72
2.3.6	Working on a slope.....	73
2.3.7	Working in an area covered with snow.....	73
2.3.8	Working on unstable ground.....	74
2.3.9	Working in a submerged area.....	74
2.3.10	Working in a muddy area.....	74
2.3.11	Working in an area with reduced visibility.....	75
2.4	Parking precautions.....	76
2.4.1	Parking location.....	76
2.4.2	Stopping the engine.....	76
2.5	Precautions for the accessories.....	77
2.6	Precautions for using optional accessories.....	77
2.7	Precautions for the battery.....	78
3	Precautions for the engine.....	79
4	Checks before starting the machine.....	80
4.1	Overall visual inspection.....	80
4.2	Checking and topping up the level of cooling fluid.....	81
4.3	Checking and topping up the engine oil level.....	82
4.4	Checking and topping up the fuel level.....	83
4.5	Checking and topping up the hydraulic oil level.....	85
5	Checks after start-up.....	87
6	Checks after use.....	89
7	operator LCD display station interfaces.....	90
7.1	Indication of functions.....	90
7.2	User Interface.....	91
7.3	Maintenance interface.....	91
7.4	Machine usage management interface.....	91
7.5	Configuration interface.....	92
8	Using the machine in cold weather.....	93
8.1	Preparation for use in cold weather.....	93



8.2	Starting in cold weather	93
8.3	Precautions after use	94
8.4	When cold weather is over	94
9	Rubber tracks.....	95
9.1	Correct use of rubber tracks.....	95
9.2	Comparison between rubber tracks / steel tracks.....	95
9.3	Rubber track warranty	95
9.4	Precautions for using rubber tracks	95
9.5	Track maintenance	97
9.6	Track replacement.....	98
10	Handling the bucket.....	99
10.1	Machine stability when using with a bucket or an accessory	99
10.2	Compatible accessories	101
10.3	Operation of the retro bucket.....	103
10.4	Digging trenches.....	103
10.5	Loading	104
11	Handling of accessories	105
11.1	Hydraulic hammer SOCOMEC.....	105
12	Accessory change by direct coupling.....	107
12.1	Dismantling the accessory	107
12.2	Mounting the accessory.....	108
12.2.1	Loading bucket.....	109
13	Load lifting.....	111
14	Implementing the 3rd hydraulic circuit.....	112
14.1	Description.....	112
14.1.1	3rd circuit selector	112
14.2	Mounting the accessory	113
14.3	Precautions for using the accessory.....	113
15	Transporting the machine	114
15.1	Loading/unloading the machine.....	114
15.1.1	Precautions for loading/unloading the machine.....	114
15.1.2	Procedure	114
15.2	Immobilising the machine on the truck	115
15.3	Tying down the machine.....	115
15.4	Slings the machine	117
16	Detecting anomalies	119
16.1	phenomena that do not constitute faults.....	119
16.2	Detecting anomalies	119
16.2.1	Engine.....	120
16.2.2	Electrical equipment.....	121
16.2.3	Machine structure.....	122
17	If the battery is discharged	123
17.1	Precautions for connecting and disconnecting the starter cables.....	123
17.2	Connecting the starter cables	124
17.3	Starting the engine	124
17.4	Disconnecting the starter cables.....	124
17.5	Charging the battery	125
18	Towing the machine	126
C	Periodic maintenance programme.....	127
1	Periodic inspections and upkeeps.....	129
2	Maintenance precautions	131



2.1	Precautions before maintenance	131
2.1.1	Stop the engine.	131
2.1.2	Removing the residual pressure	131
2.1.3	Place a warning label	132
2.1.4	Establish a safety perimeter.....	132
2.1.5	Keep the machine clean	132
2.2	Precautions during maintenance.....	133
2.2.1	Oil and grease.....	133
2.2.2	Tools	133
2.2.3	Parts.....	133
2.2.4	Dismantling the accessory	134
2.2.5	Working under the machine.....	134
2.2.6	Lighting	134
2.2.7	Battery.....	135
2.2.8	Hoses	135
2.2.9	Radiator ventilator	135
2.2.10	Soldering.....	135
2.2.11	Waste processing.....	136
3	Recommended greases and fluids	137
4	First maintenance	138
4.1	After the first 50 hours of service	138
4.2	After the first 250hours of service.....	138
5	List of periodic inspections and maintenance operations.....	139
6	Maintenance by the operator	142
6.1	Daily maintenance.....	142
6.1.1	Checking the machine before use	142
6.1.2	Checks after using the machine	142
6.1.3	Checking the commands	142
6.1.4	Checking the seat.....	142
6.1.5	Greasing points	143
6.1.6	Using the centralized greasing system.....	144
6.1.7	Cleaning the separator/decanter.....	145
6.1.8	Purging the fuel tank.....	146
6.1.9	Checking the hydraulic hoses.....	145
6.1.10	Visual inspection of the fuel hoses	148
6.2	Maintenance every 50 hours	148
6.2.1	Greasing the pin and rotation crown.....	148
6.3	Non periodic maintenance.....	146
6.3.1	Fuse replacement.....	146
6.3.2	Top up the windscreen washer fluid. (for cab).....	147
6.3.3	Replacing the windscreen wiper (for cab).....	147
6.3.4	Accessory state check	147
6.4	Rubber track maintenance.....	147
6.4.1	Checking the condition of the tracks	147
6.4.2	Track replacement.....	149
6.4.3	Tension check.....	149
6.4.4	Increasing the tension.....	150
6.4.5	Releasing the tension	151
6.5	Steel track maintenance.....	152
6.5.1	Checking the condition of the tracks	152
6.5.2	Track replacement.....	152
6.5.3	Tension check.....	152



6.5.4	Increasing the tension.....	153
6.5.5	Releasing the tension.....	154
7	Maintenance by the dealer.....	155
D	Conservation and storage.....	157
1	Conservation.....	159
2	Storage.....	160
3	Recommissioning.....	161
E	Technical data.....	163
1	Specifications.....	165
2	Working dimensions.....	166
3	Noise emitted by the machine.....	167
4	Vibrations emitted by the machine.....	168
F	Lifting capacities.....	169
1	Lifting SV26 Cabin.....	171
2	Lifting SV26 Canopy.....	172
	Appendices.....	173
A	List of error codes displayed on the operator display station.....	174
B	Control sheets to be photocopied.....	177
C	Notes.....	183
D	Lashing record.....	184
	Index.....	185





A Description and illustration of the machine

CHAPTERS COVERED IN THIS CHAPTER:

- 1 APPLICATIONS AND REGULATIONS
- 2 IDENTIFICATION PLATES
- 3 WARNING LABELS
- 4 IDENTIFICATION OF IMPORTANT PARTS
- 5 DESCRIPTION OF THE DRIVING POSITION
- 6 HEATING VALVE
- 7 OPTIONS
- 8 COVERS





1 APPLICATIONS AND REGULATIONS

1.1 Applications

The machine is designed to carry out the following tasks :

- excavation
- ground levelling
- shovelling
- trench digging and ridging
- loading
- lifting (optional)

CAUTION

The machine must not be used for any tasks that are not covered.

1.2 Warranty

Refer to the maintenance book.

1.3 Driving permits

Before using this machine, check the requirements applicable to its use concerning the driving permits. Respect all applicable laws. See your dealer for questions about usage permits.

1.4 Lifting

- Using the machine as a hoist is subject to the Machinery Directive 2006/42/EC for members of the European Community, and to the legislations specific to each country for states outside the EC. YANMAR CONSTRUCTION EQUIPMENT EUROPE S.A.S. declines all responsibility for any use of the machine that does not respect the instructions in this standard.
- Consult your YANMAR dealer for more information about the lifting function.

CAUTION

It is forbidden to transport or lift people with the machine.

2 IDENTIFICATION PLATES

2.1 Machine serial number plate

- The machine's serial number plate is located on the rotating frame, as shown opposite. Never remove this plate for any reason.

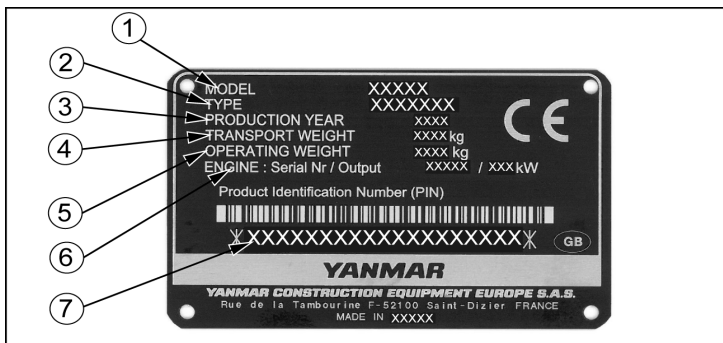
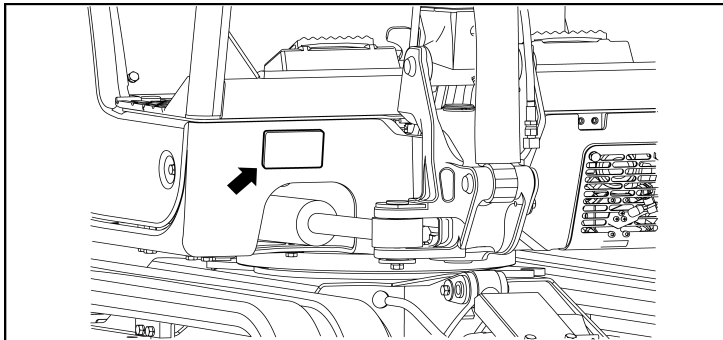

1= Model name

2= Type (Machine Category)

3= Date of manufacture of the machine

4= Transport weight (Machine weight without operator, equipped with a standard bucket and tanks topped off)

5= Weight of the machine (with operator +75 kg)

6= Serial number and engine power

7= Machine serial number

2.2 Engine serial number plate

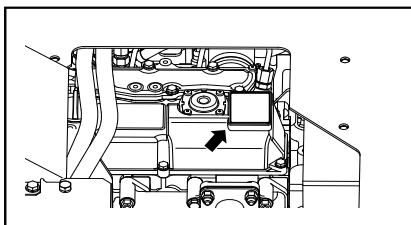

The engine's serial number plate is located on the top of the lifting arm lever cover and on the adhesive label located inside the bonnet. Never remove this plate for any reason.

2.3 EPA information plate

The EPA information plate is attached to the engine. Never remove this plate for any reason.

2 Identification plates

2.4 Spare parts order and intervention request

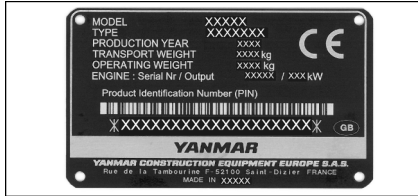

When you order spare parts or call for an intervention, tell your dealer the model name, the serial number of the machine and the serial number of the engine and the number of hours displayed on the time counter.

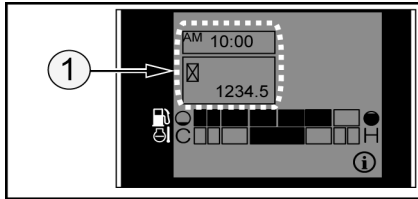

1 = Time counter



3 WARNING LABELS

- Several safety messages are configured on the machine. The description and location of all the safety messages are provided in this chapter. Check regularly to see whether all the messages are in the correct location and are legible.
- If an adhesive label is missing, damaged or illegible, replace it straight away. In the same way, if an adhesive label is on a part that has been replaced, add a new adhesive label to the new part.
- Contact your YANMAR dealer to obtain new adhesive labels. The part code number is clearly indicated on each label.

3 Warning labels

3.1 Location of the warning adhesive labels

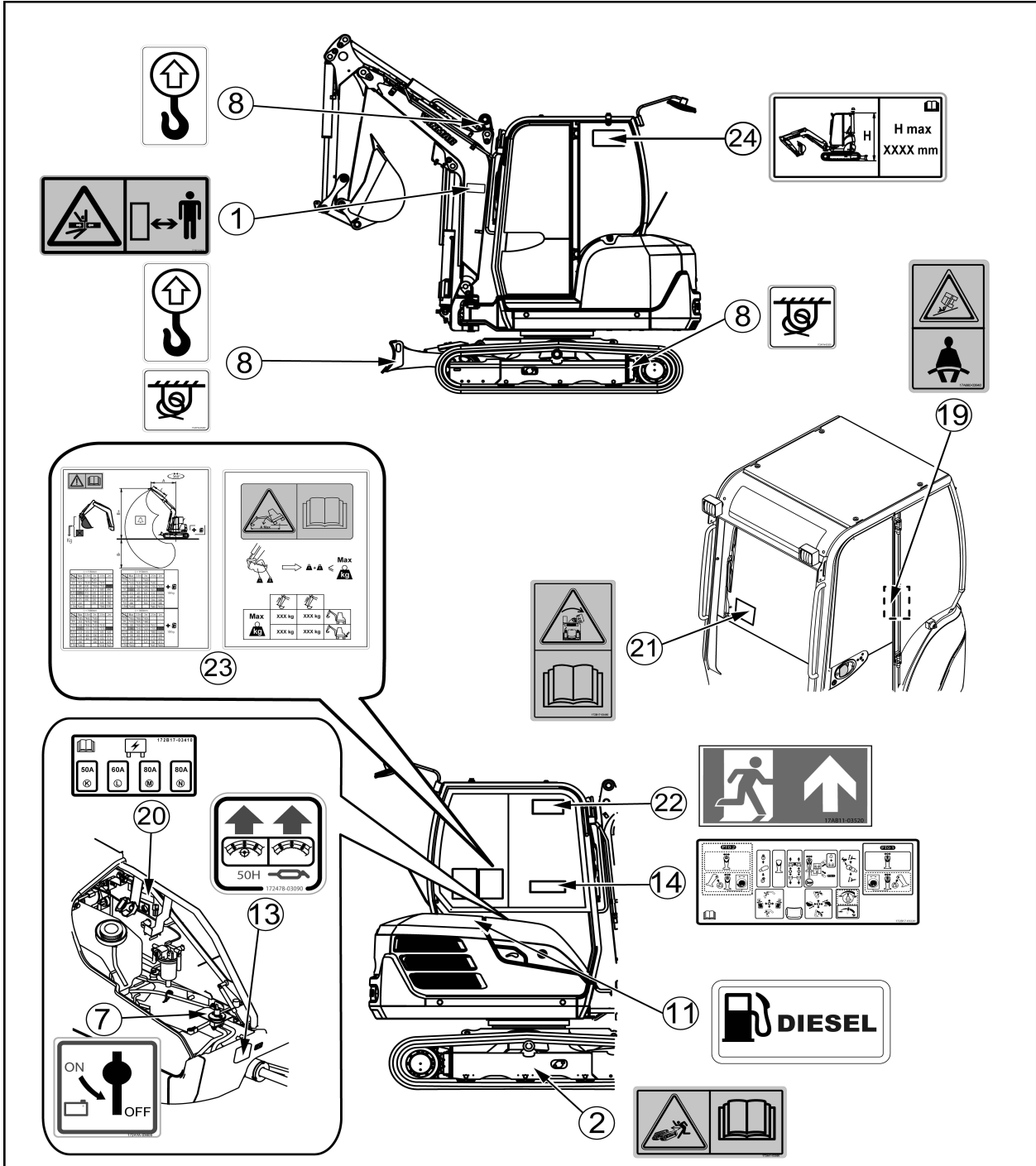

3 Warning labels

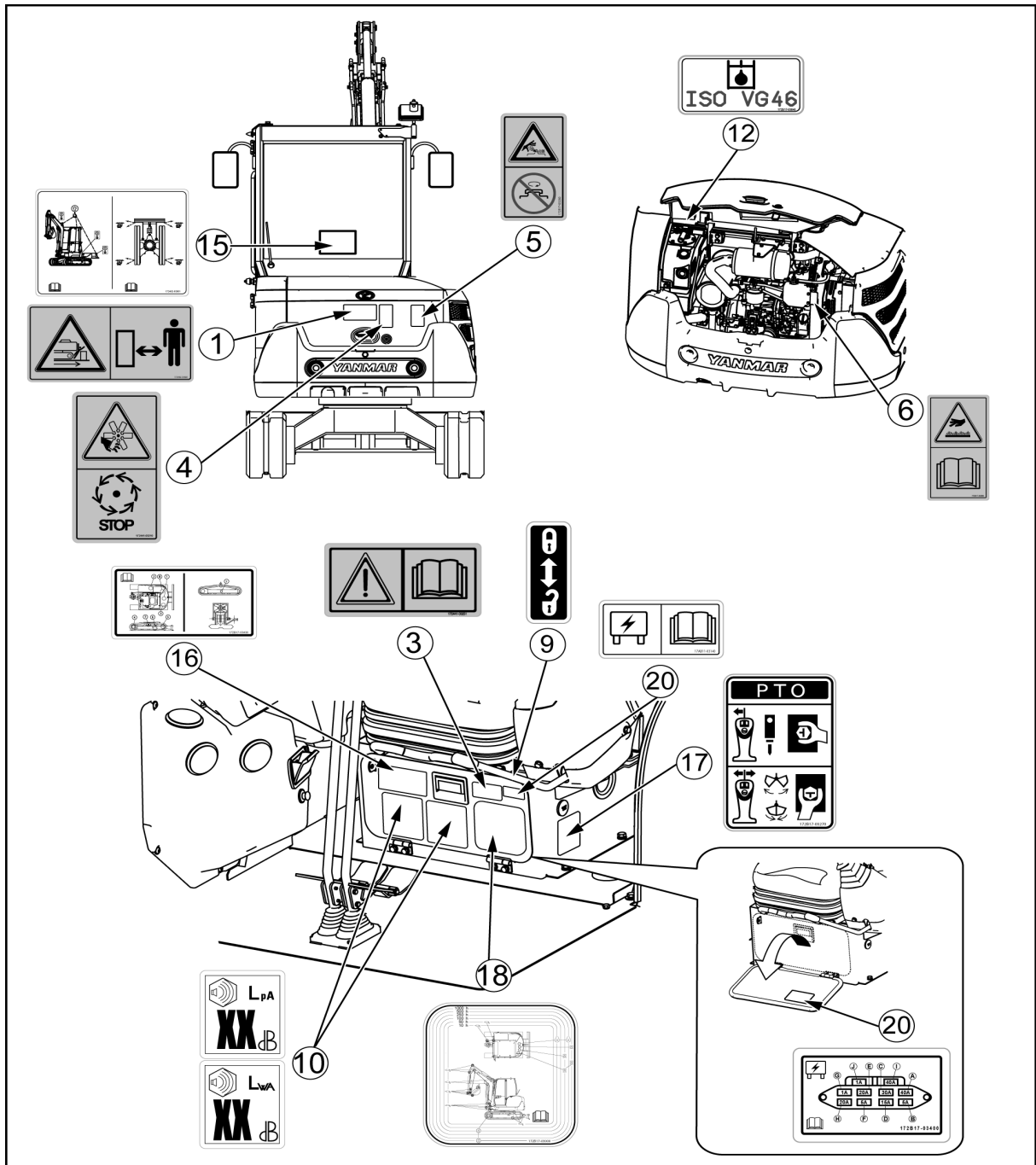

3 Warning labels

3.2 Explanation of the warning adhesive labels

1		<p>Machine's Danger Zone</p> <p> 2.2 Movement precautions, page 66</p> <p> 2.2.4 Dismantling the accessory, page 134</p> <p> 2.2.1 Machine's Danger Zone, page 66</p>
2		<p>Pressurised product. Read the user manual.</p> <p> 6.4 Rubber track maintenance, page 147</p>
3		<p>Read the user manual.</p> <p> 2.1.5 Accessing the machine, page 65</p> <p> 2 Usage precautions, page 63</p>
4		<p>Do not remove the protective casings while the machine is running.</p> <p> 2.2.9 Radiator ventilator, page 135</p>
5		<p>Pressurised elements. Do not unscrew while the liquid is hot.</p> <p> 1.8 Avoid removing the caps when the temperatures are high, page 61</p>
6		<p>Hot surfaces.</p> <p> 4.3 Checking and topping up the engine oil level, page 82</p>
7		<p> 8.3 Circuit breaker, page 56</p>
8		<p>Transporting the machine</p> <p> 15.4 Slinging the machine, page 117</p> <p> 15.3 Tying down the machine, page 115</p>

3 Warning labels

9		5.3.1 Locking lever, page 23
10		Measured sound pressure 3 Noise emitted by the machine, page 167
11		4.4 Checking and topping up the fuel level, page 83
12		Hydraulic oil 3 Recommended greases and fluids, page 137 4.5 Checking and topping up the hydraulic oil level, page 85
13		Using a grease pump, grease the pin and the rotation crown at the greasers indicated with arrows on the figure opposite. 6.2.1 Greasing the pin and rotation crown, page 146
14		This sticker describes the operation of the machine controls and their location relative to the operator seat. = Options 5.3 Joysticks and pedals, page 22
15		Tie-down and slinging plans for the machine 15 Transporting the machine, page 114
16		Filler holes for various reservoirs on the machine and track tension system. 3 Recommended greases and fluids, page 137 6.4 Rubber track maintenance, page 147 6.5 Steel track maintenance, page 152
17		Use this valve to select the 3rd hydraulic circuit in single or dual effect. 14.1.1 3rd circuit selector, page 112

3 Warning labels

18		<p>Scheduled maintenance points of the machine (lubrication, filters...)</p> <p> 1 Periodic inspections and upkeeps, page 129</p>
19		<p>Always fasten your safety belt and adjust it before starting the machine.</p> <p> 2.1.6 Fasten your safety belt and adjust the rearview mirror (s), page 65</p>
20		<p>Fusebox</p> <p> 5.7 Fuses, page 29</p>
21		<p>Interference between the bucket and the machine.</p> <p> 10.2 Compatible accessories, page 101</p>
22		<p> 1.13 Cabin's emergency exit, page 62</p>
23		<p>The maximum weight when in use in bucket mode or with accessories ensure machine dynamic stability in use. It corresponds to the maximum weight allowed at the end of the empty arm.</p> <p> 10.1 Machine stability when using with a bucket or an accessory, page 99</p> <p>Lifting capacities</p> <p> F Lifting capacities, page 169</p>
24		<p>Before starting the machine transportation, check the total height of the load.</p> <p> 15.3 Tying down the machine, page 115</p>

4 IDENTIFICATION OF IMPORTANT PARTS

4.1 General view of the machine

A = Right

B = Left

C = Front

D = Rear

1= Blade

2= Boom cylinder

3= Bucket

4= Bucket pin

5= Bucket link

6= Arm

7= Bucket cylinder

8= Arm cylinder

9= Boom headlamp

10= Boom

11= Cabin

12= Sprocket wheel

13= Support roller

14= Track roller

15= Idle wheel

16= Track

17= Boom base

18= Boom rotation cylinder

19= Blade cylinder

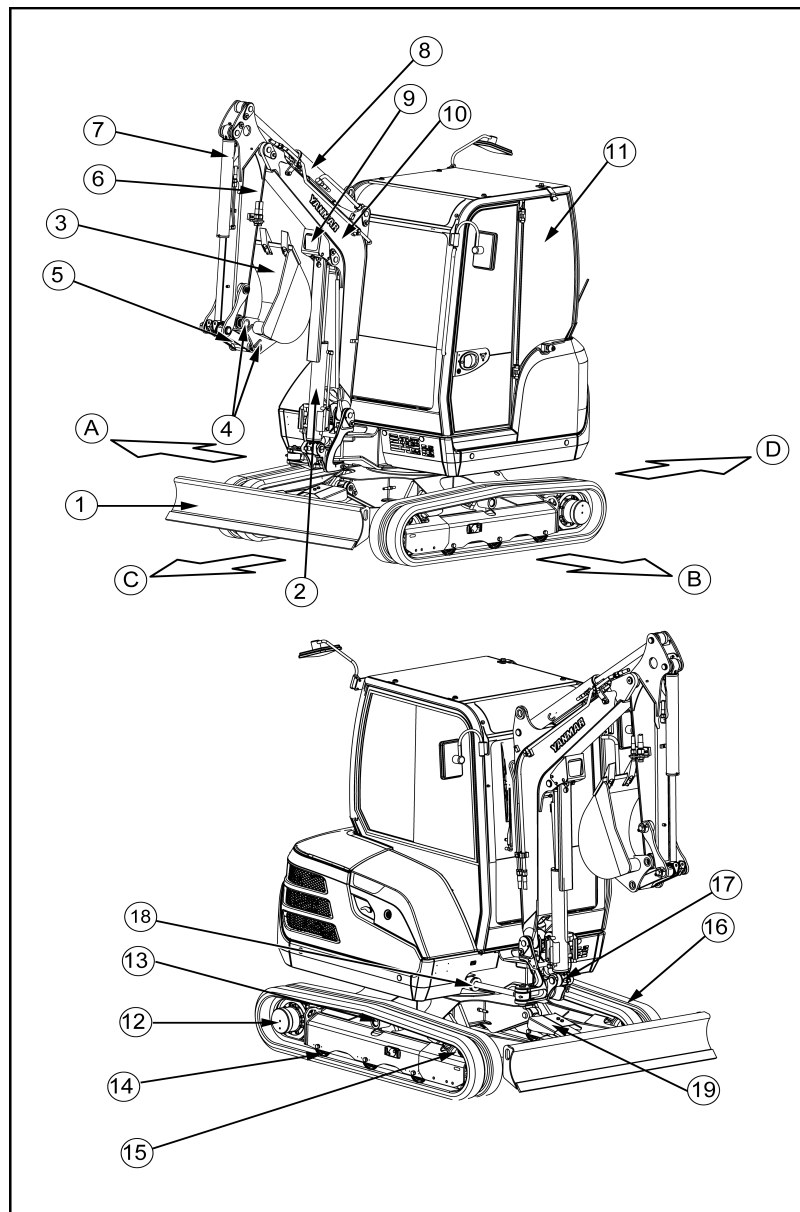

4 Identification of important parts

4.2 Commands and switches

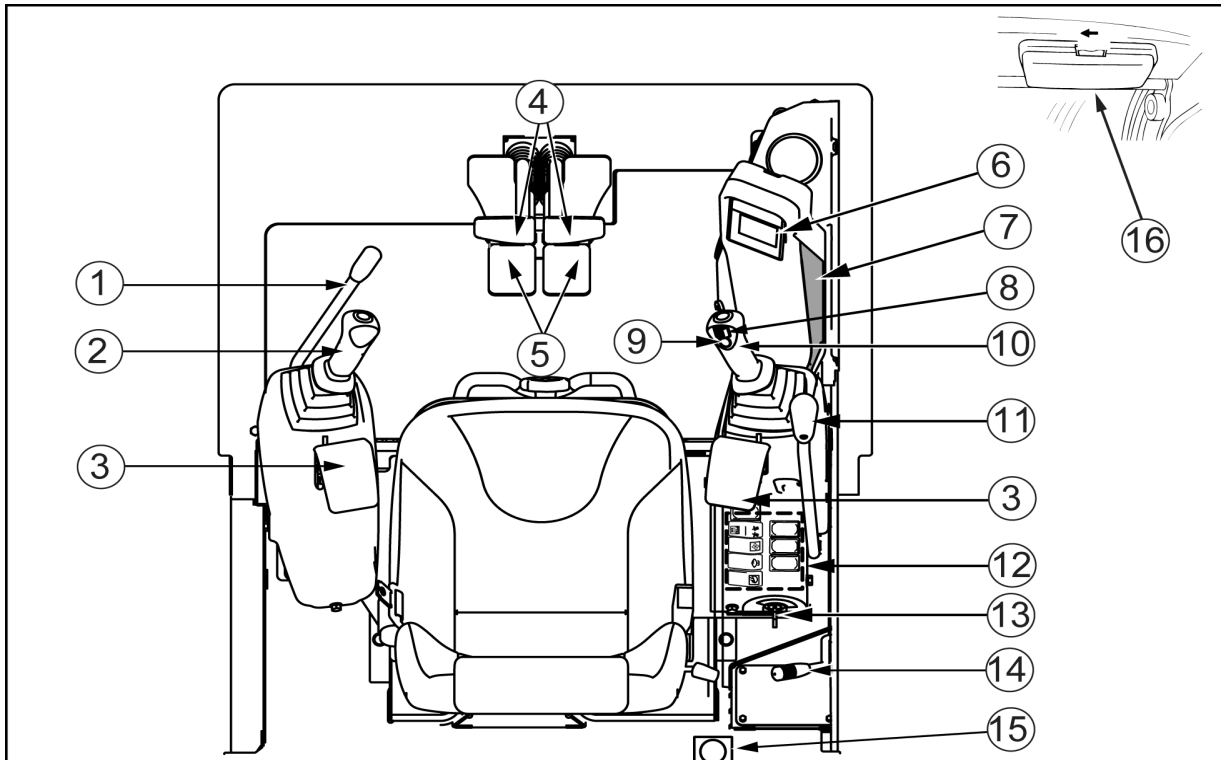

1= Locking lever

2= Left command lever

3= Armrest

4= Slide movement levers

5= Side movement pedals

6= Operator display station

7= Glove-box

8= 3rd hydraulic circuit control

9= Horn

10= Right command lever

11= Blade lever

12= Control panel

13= Start key

14 = Throttle lever

15 = Cup holder

16= Interior lighting switch (for cab)

5 DESCRIPTION OF THE DRIVING POSITION

This section describes the different command mechanisms necessary to operate the machine. In order to work in complete safety and comfort, it is vital that you understand how to operate and use these mechanisms.

5.1 Operator display station

- When the starter key is in ON position, the lights come on and the alarm sounds.
- All the lights go off after the engine is started. If a problem occurs when starting, a light comes on and the alarm sounds.

WARNING

When an indicator light comes on and the alarm sounds during operation, stop the engine immediately and follow the steps recommended in this manual.

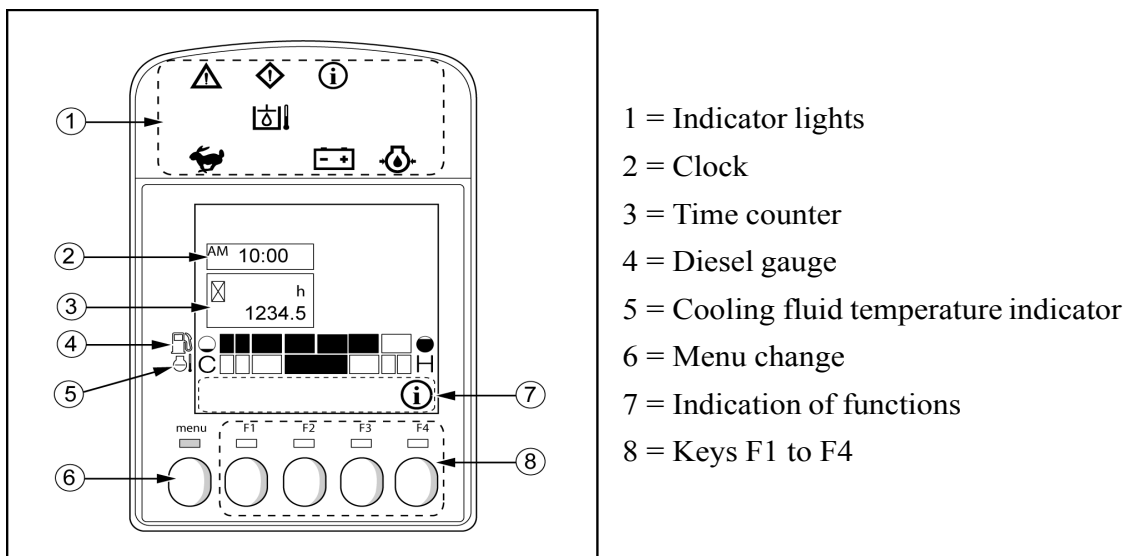

For the advanced features on the operator display station:

7 operator LCD display station interfaces, page 90

5.1.1 Indicator lights

	Warning light		Alert light		Information symbol	
			Hydraulic oil temperature gauge			
	Increased speed				Battery charge warning alert	
						Engine oil pressure alert indicator

5 Description of the driving position

a. Warning light



If the warning light flashes and the alarm sounds continuously, immediately stop using the machine. After stopping the machine, check the error details and take corrective measures.

b. Alert light



If the alert light blinks and the alarm sounds intermittently, stop the machine as soon as possible. After stopping the machine, take the necessary corrective measures.

c. Information symbol



The information indicator will flash to indicate the presence of information such as maintenance indications. Press F4 to view the details.

d. Hydraulic oil temperature gauge



This indicator lights only at startup and it does not have any function on this machine.

e. Travel speed indicator



Increased speed

This indicator shows that the 2nd gear is engaged.

f. Battery charge warning alert



- If the battery is not correctly charged, the warning light will come on.
- In this case, check the battery charge circuit.
- If you detect any faults, contact your dealer.

g. Engine oil pressure alert indicator



If the engine oil pressure is abnormal, the warning light comes on and the buzzer sounds. In this case, shut down the engine

 **16.2.1 Engine, page 120**

5 Description of the driving position

5.1.2 Diesel gauge

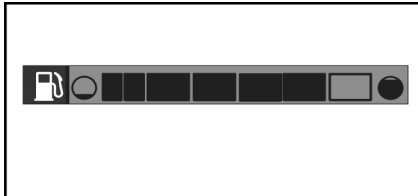

● = Full

○ = Empty

- The diesel gauge operates when the starter key is in ON position. It indicates the level of diesel in the tank.
- When the gauge reaches the two indicators near the symbol "Empty" (the leftmost cubes), fill up as soon as possible.

5.1.3 Cooling fluid temperature indicator

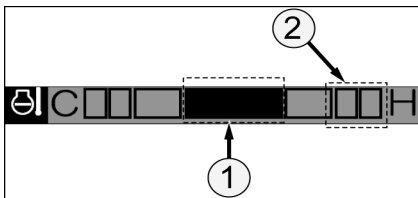

C = cold

H = hot

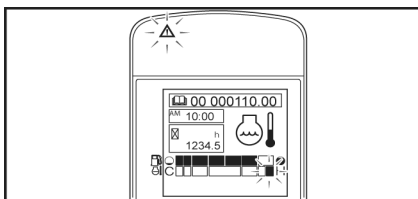

- It indicates the temperature of the engine cooling fluid. The normal temperature is close to zone (1) during normal operation.
- If the temperature of this coolant reaches the limit (2) during working, then slow the engine down and wait for it to return to normal.
- When the engine is cold, top up with cooling fluid following the procedure described in chapter **4.2 Checking and topping up the level of cooling fluid, page 81**

5.1.4 Time counter

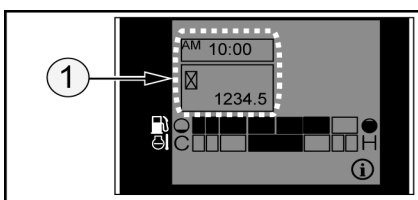

1 = Time counter

- The time counter indicates the number of hours for which the machine has been working.
- When the engine is running, the time counter permanently records the time even if the machine is not being used.
- The time counter records "1" for one hour without considering the engine rotation speed.
- The decimal to the far right records "1" for 0.1 hours (6 minutes).

5 Description of the driving position

5.1.5 Navigation keys

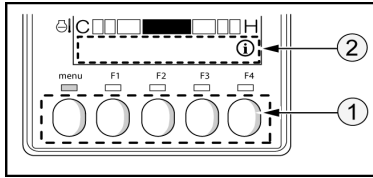

Keys F1 to F4

Use these buttons to launch the operations corresponding to the icons displayed above the function indicator bar.

7.1 Indication of functions, page 90

1= Keys F1 to F4

2= Indication of functions

5.1.6 Information and error icons

Date and time setting indicator

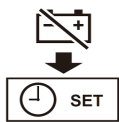

The time and date must be set from the settings screen.

Note

If the battery in the machine is removed, the date and time settings will be reset.

Maintenance notice

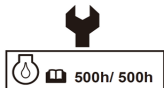

This icon indicates on the basis of the machine's accumulated hours of use that the maintenance period for an maintenance object has been reached. Required maintenance must be performed after referring to the maintenance section of this manual.

When the maintenance has been performed, the accumulation of maintenance time must be reset from the maintenance interface.

1 Periodic inspections and upkeeps, page 129

Engine stop icon



- If the control panel displays this icon alternately with another icon, stop the engine immediately.

Take the necessary corrective measures.

Error icon



- This icon indicates an error other than those described above.
- Refer to the list of error codes to identify the problem and contact your dealer.

5 Description of the driving position

Other errors

- In case of problems on the machine different from that already described, if the warning light is flashing and the STOP icon appears on the operator display station as well an error code, stop the machine immediately and contact your dealer.

 **A List of error codes displayed on the operator display station, page 174**

5.2 Switches

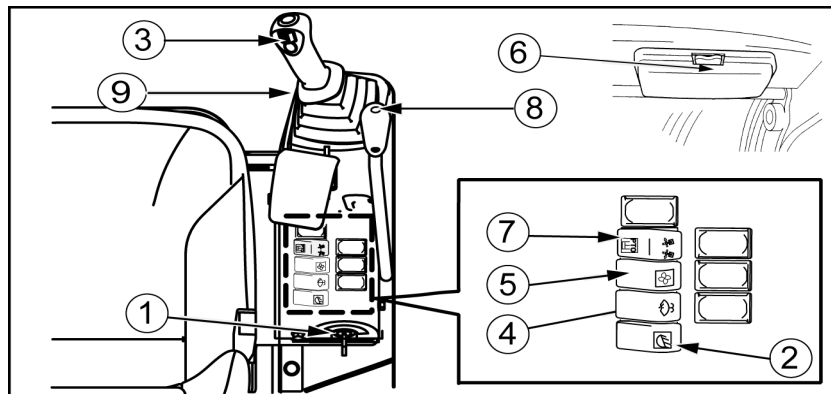

1= Start key

2= Headlight switch

3= Horn

4= Windscreen wiper switch and windscreen wiper

5= Ventilation switch

6= Interior lighting switch

7= Boom rotation selection switch / PTO 1

8= 2nd gear switch

9= Cigar lighter

 **7 Options, page 37**

5 Description of the driving position

5.2.1 Start key

IMPORTANT

The machine is fitted with an electrical safety system. If the locking levers are not in safety position, the engine cannot start.

- Use this command to start and stop the engine.

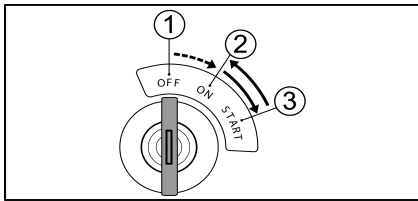

- 1= OFF
- 2= ON
- 3= START

OFF position = shutdown

Turn the key to OFF position to switch off the engine and disconnect the electrical circuit.

ON position = operation

Turn the key to the ON position to turn on the power circuit and the charging circuit. Keep the key in this position while the engine is running.

START position = startup

Turn the key to START position to start the engine. Release the key after the engine starts and it will return itself to ON position.

5.2.2 Headlight switch

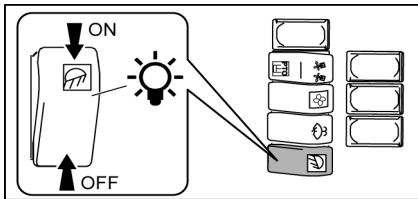

- ON : The headlights come on.
- OFF : The headlights switch off.

IMPORTANT

Do not leave the headlights switched on when the engine is not running. The battery will discharge and the engine will be unable to start.

5.2.3 Cigar lighter

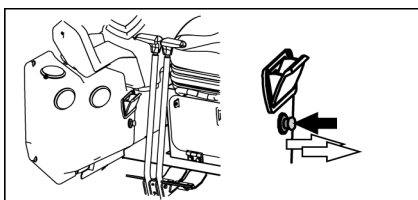

Push in the button. It rises automatically when the resistance is hot.

IMPORTANT

If the cigar lighter does not rise after 20 seconds, this means there is a problem.

5 Description of the driving position

5.2.4 Horn

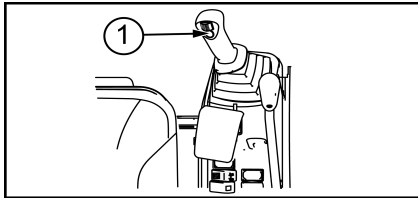

Press the switch at the top of the right joystick to activate the horn.

1= Horn

5.2.5 Windscreen wiper switch and windscreen wiper

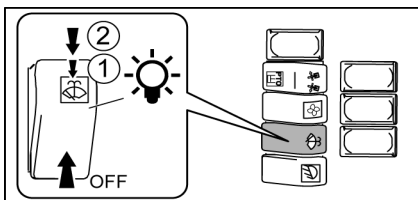

- This switch is used both for the windscreen wipers and the washer.

1 = The windscreen wipers work.

2= Press and hold the switch to spray wiper fluid onto the windscreen.

OFF: The windscreen wipers stop.

- Check the windscreen washer fluid level daily.

IMPORTANT

Do not press the washer command when the washer tank is empty as this may damage the pump.

Using windscreen wipers on a dry windscreen may damage the glass. Only use the windscreen wipers when the windscreen is wet.

The windscreen wiper blade may freeze in cold weather. Do not try to activate it if it is frozen as this may damage the windscreen wiper motor.

5.2.6 Ventilation switch

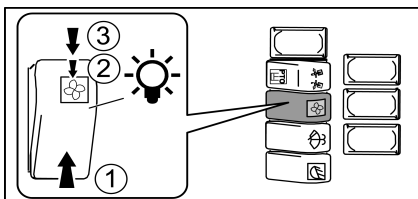

- Use this switch to evacuate the air from the cab. Move the switch to select the ventilator speed.

- The selector is used to select the air volume by selecting :

– 1 : Ventilator stopped.

– 2 : Reduced ventilator speed.

– 3 : High ventilator speed.

6 Heating valve, page 36

5 Description of the driving position

5.2.7 Interior lighting switch

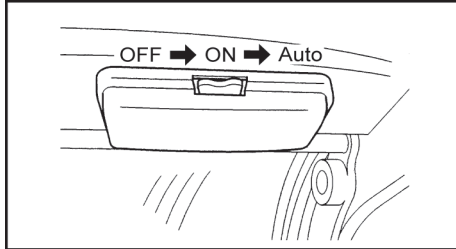

ON : The lighting is activated.

OFF : The lighting is deactivated.

Auto: At the opening of the door, a timer switches the interior lights on for 15 seconds. The interior light automatically turns off when the cabin door is closed.

5.2.8 Boom rotation selection switch / PTO 1

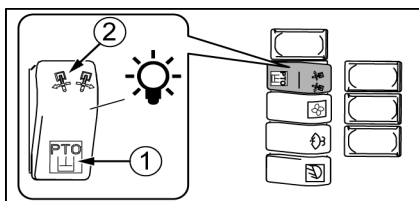

- Press this button to select the knob mode of operation on the right joystick.
- When the switch is positioned on boom rotation, the alarm is triggered.

1= P.T.O.1

2= Rotation of the boom

5.3.3 3rd hydraulic circuit control (P.T. O. 1), page 24

5.2.9 2nd gear switch

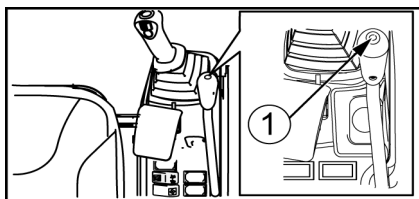

1. To switch to 2nd gear, press the switch on the blade lever. The 2nd gear indicator lights on the LCD monitor.

1= 2nd gear switch

2. Press the second gear switch again to return to normal speed. The light goes out.

5 Description of the driving position

5.3 Joysticks and pedals

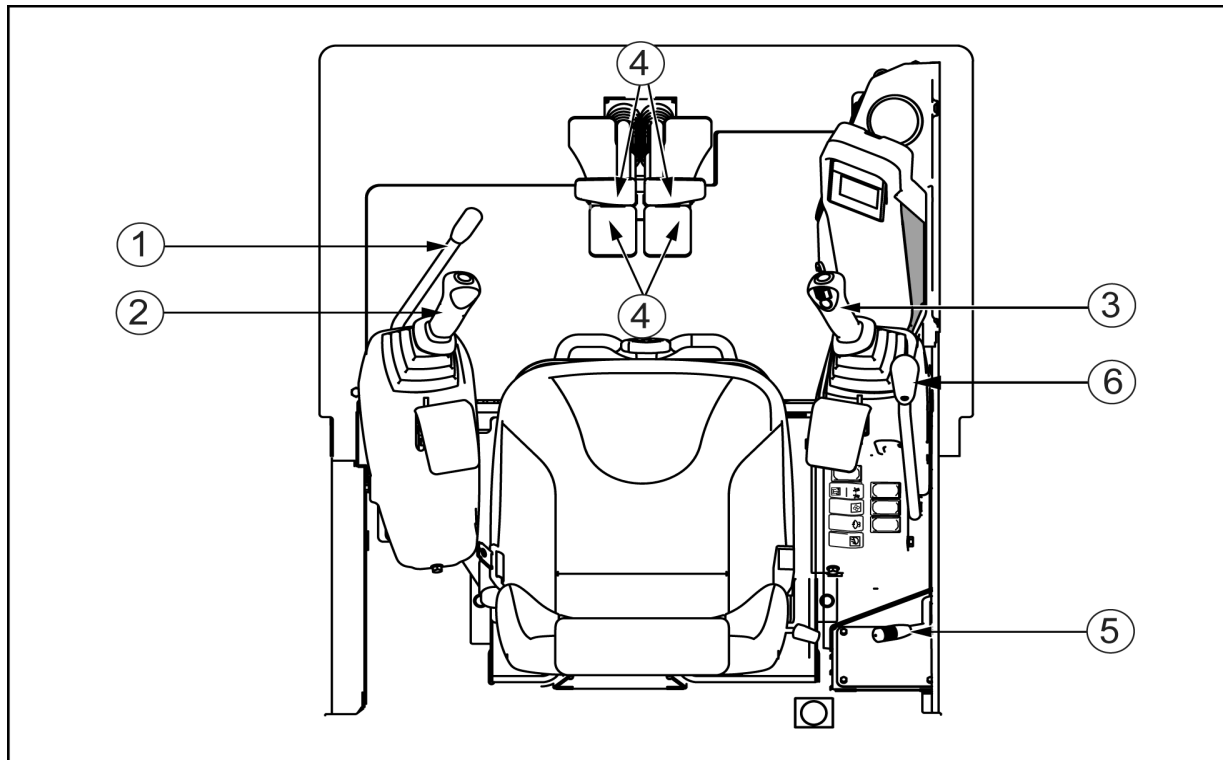

- 1= Locking lever
- 2= Left command lever
- 3= Right command lever & Rotation of the boom
- 4= Travel levers and pedals
- 5= Throttle lever
- 6= Blade lever & 2nd gear switch

5 Description of the driving position

5.3.1 Locking lever

⚠ WARNING

The blade movement is not secured by the locking lever, even when the latter is in the locked position.

- The locking levers condemn the joysticks as well as the travel.
- When you raise the left hand locking lever, the left hand command lever is raised.

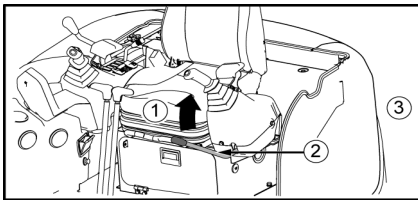

- 1 = Locking
- 2 = Locking lever
- 3 = Left hand side

⚠ IMPORTANT

The machine is fitted with a hydraulic safety system. If the lever is in the safe position, all the hydraulic cylinders for the boom, the arm and the bucket, as well as the boom rotation and travel can not be activated, although the left and right joysticks can be manipulated.

⚠ WARNING

Place the locking lever(s) in locked position as soon as you leave the seat.

⚠ WARNING

The movement relationship between the command lever mechanism and the equipment movements they produce are described in detail in this manual. To avoid any accidents due to handling errors, it is prohibited to modify the hydraulic circuit when reconnecting the hydraulic cylinder hoses and valves.

5.3.2 Right command lever

- The right hand command lever is used to handle the boom and the bucket.

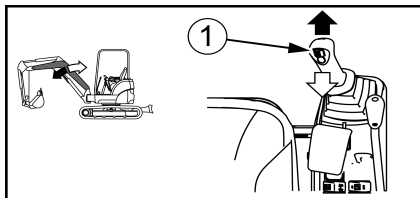

- Handling the arrow
- 1 = Right command lever

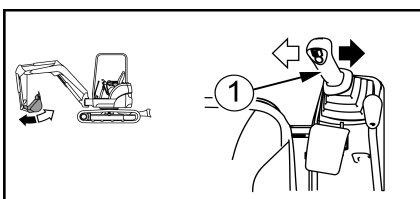

- Handling the bucket
- 1 = Right command lever

- When you release the lever, it returns to neutral position and the respective movements stop.

5 Description of the driving position

5.3.3 3rd hydraulic circuit control (P.T.O. 1)

P.T.O. switch

- Use the proportional roller to adapt the dual effect P.T.O. rate.

14 Implementing the 3rd hydraulic circuit, page 112

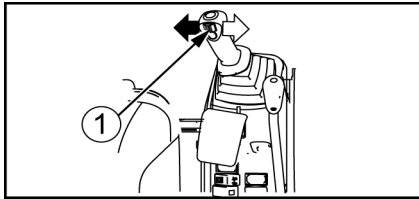

1 = Proportional roller

◀▶ Dual action accessory (tilt bucket, auger, etc.) : operate only the proportional roller.

5.3.4 Left command lever

- The left hand joystick is used to control the arm movements and the rotation of the upper part.

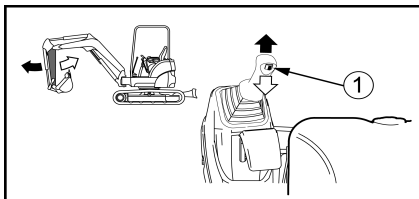

Handling the arm

1 = Left command lever

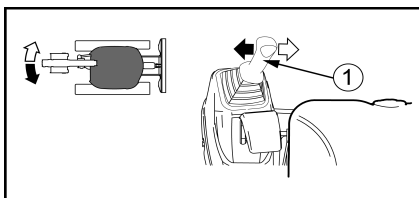

Rotation of the upper part

1 = Left command lever

- When you release the lever, it returns to neutral position and the respective movements stop.

5 Description of the driving position

5.3.5 Travel levers and pedals

DANGER

It is strictly forbidden to handle the machine controls outside the cockpit.

Incorrect use of the machine may cause serious injury or even death. Personnel involved in using and maintaining the machine must familiarise themselves with the content of this manual before carrying out a task.

WARNING

Before handling the travel levers, check whether the machine is in normal or reverse position. The machine is in the normal position when the blade is on the same side as the work equipment.

If the machine is in the reverse position, the displacement levers must be handled in reverse to move forward and backward.

Normal position

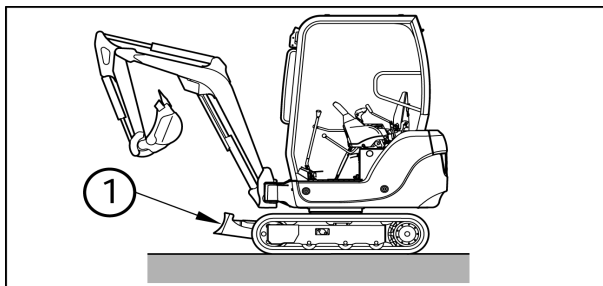

1 = Blade

Opposite position

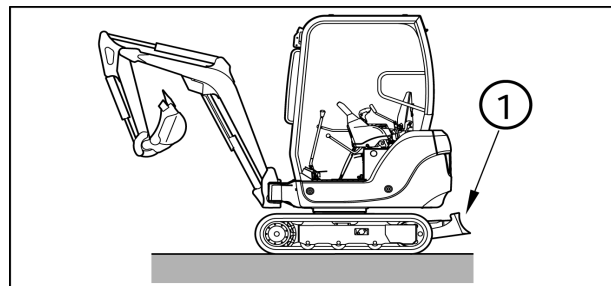

1 = Blade

5 Description of the driving position

Description of the movements in the normal position

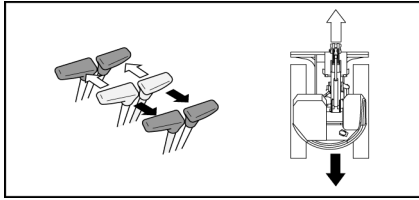

- To move the machine forward, push the travel levers, or press the back of the pedals.
To move the machine backwards, pull the travel levers, or press the back of the travel pedals.

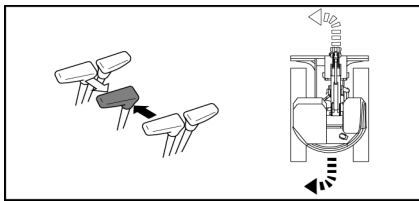

- To turn to the left with the machine moving:
 1. Position the travel levers forward or rearward.
 2. Turn the travel lever left into neutral to turn the machine.

To turn right, do the same thing with the right travel lever.

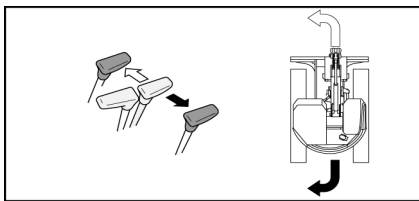

- To turn to the left with the machine stopped:
 1. Position the travel levers in the neutral position.
 2. Push the right travel lever to rotate forward or pull the right travel lever to turn backwards.

To turn right, do the same thing with the left travel lever.

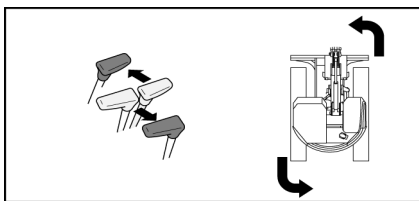

- To make a rotating turn of the machine to the left:
 1. Position the travel levers in the neutral position.
 2. Push the right travel lever forward and pull the left travel lever rearward.

To make a rotating turn of the machine to the right, reverse the operation of the levers.

5 Description of the driving position

5.3.6 Blade lever

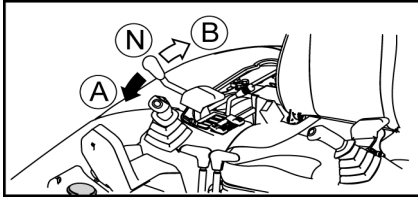

- Use this lever to command the blade.
- Push the lever forward to lower the blade. (A)
- Pull the lever back to raise the blade. (B)
- If the lever is released, it return to neutral position and the blade remains in its position. (N)
- Use the switch on the blade lever to switch to second gear.

5.2.9 2nd gear switch, page 21

WARNING

The blade movement is not secured by the locking lever, even when the latter is in the locked position.

Do not operate the blade lever when you are not using it.

5.4 Power socket

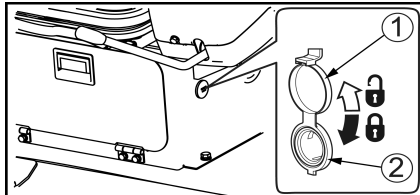

- The intake, located on the left under the seat, works when the ignition key is in the ON position. Appliances up to 12V-120W (10A) may be connected.

1= Lid

2= Power socket

IMPORTANT

Always close the lid if the plug is not used to seal for dust.

Prolonged use when the engine is switched off may damage the battery.

5 Description of the driving position

5.5 Driver's seat

- Adjust the seat position so that the driver can operate the controls easily and comfortably.

WARNING

Do not adjust the seat position when you are working on the machine; adjust it before you start.

Always fasten your safety belt and adjust it before starting the machine.

Seat position adjustment

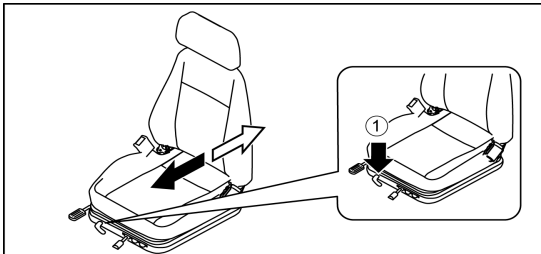

- Pull the lever (1) to move the seat forward and back.

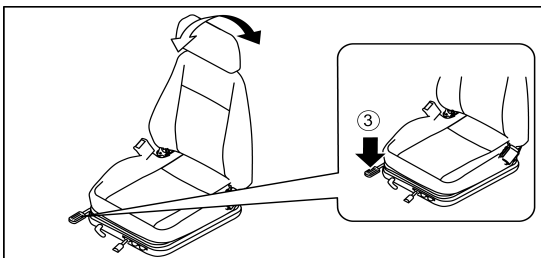

- Pull lever (3) to adjust the seat back.

Suspension adjustment

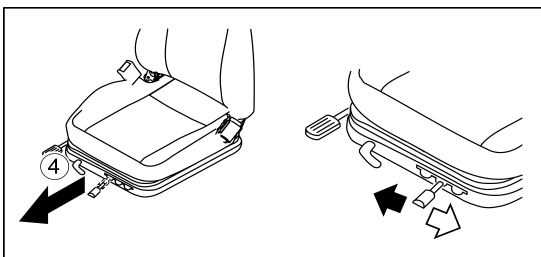

- The seat suspension (4) can be adjusted according to the weight of the driver:

- Firm suspension
- Flexible suspension

5.6 Location for the tools and user manual

5.6.1 Toolkit

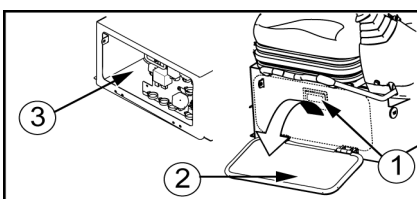

- The space for the toolkit is underneath the driver's seat.
- Pull the lever (1) to open the lid (2).
- Keep the toolkit in the compartment provided for the purpose. (3)

5 Description of the driving position

5.6.2 User manual

- The location for the user manual is in the document holder below the ceiling.
- Pull the tab to unlock the box and open it.
- To close it, push the lid until it locks.

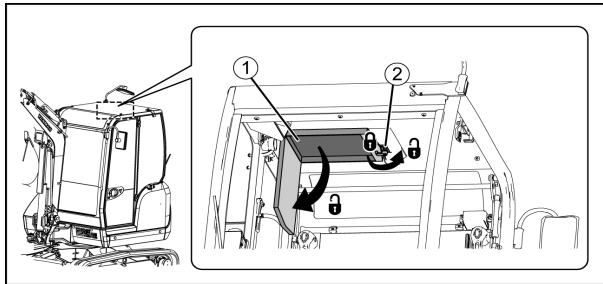

1= Document holder
2= Opening tab

5.7 Fuses

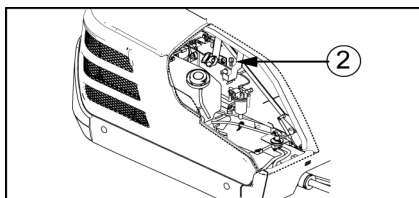
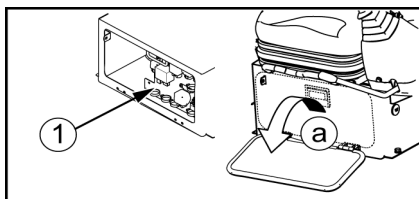

- The fuses protect the equipment and the electrical cabling against a surge. In case of a bad contact, or if the electrical system does not work when the key is on, replace the faulty fuse with a fuse in good condition.

6.3.1 Fuse replacement, page 146

- The general supply fuses are located beside the battery, under the seat.
- The fusebox is underneath the driver's seat.

a = opening

1= General supply fuses

2 = Delayed action fuses

5 Description of the driving position

5.7.1 Fusebox

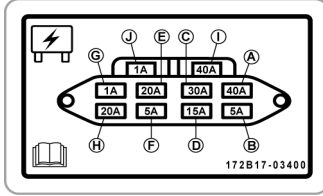

Symbol	Fuse capacity	Circuit name
A	40A	Cigar lighter Heating Cab lighting
B	5A	Operator display station
C	30A	Boom headlamp Switches Operator display station Horn Movement alarm (<i>Options</i>) Safety valves (<i>Options</i>)
D	15A	Windscreen wiper Windscreen washer
E	20A	Safety relay Anti theft mechanism (<i>Options</i>) Preheating relay Operator display station Enginestop solenoid Alternator Electric engine fuel supply pump Right command lever Left command lever Boom rotation relay / PTO 1
F	5A	Safety valves (<i>Options</i>) Cut-off valve
G	1A	Radio (<i>Options</i>)
H	20A	Centralized greasing system (<i>Options</i>) Automatic engine idle (<i>Options</i>) Plug-in flashing light (<i>Options</i>)
I	40A	Spare fuses
J	1A	

5 Description of the driving position

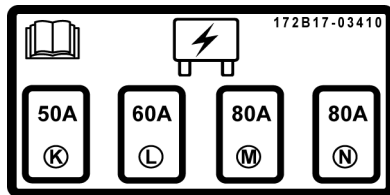

Symbol	Fuse capacity	Circuit name
K	50A	Preheating relay
L	60A	Enginestop solenoid Safety relay
M	80A	Starter Alternator
N	80A	Main circuit

5.8 Ash tray

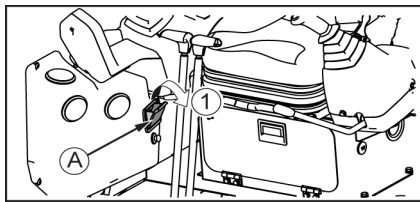

- Pull the ash tray to open it (1). Close it again when it is not being used.
- To empty and clean it, press on the two ends and pull it towards you. To put it back, slide it into its housing, keeping it flat.

A = Ash tray

WARNING

Do not place any flammable products in the ash tray.

5 Description of the driving position

5.9 Cabin

CAUTION

The upper and lower parts of the windscreen can be opened. The opening and closure of the windscreen must be secured with the safety levers in order to avoid any sudden, unplanned closure which may cause injuries:

Do not pass our hand or head through the open door or windscreen.

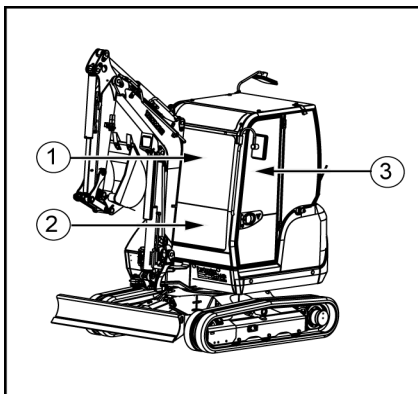

- 1= Upper windscreen
- 2= Lower windscreen
- 3= Side door

WARNING

Place the locking lever(s) in locked position to avoid any unplanned operation of the joysticks when handling the windscreen.

5.9.1 Cab side door

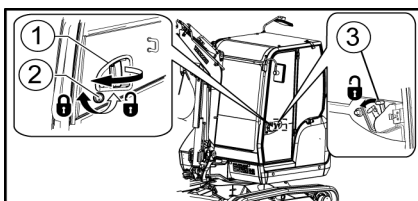

- 1 = Exterior handle
- 2= Key
- 3= Interior handle

a. Opening and closing of the door

From the exterior

- To open the door :
 1. Insert the key into the lock.
 2. Turn the key anti-clockwise to unlock the door.
 3. Pull the exterior handle to open the door.

- To close the door :

Slam the door and turn the key clockwise to lock it.

From the interior

- Pull the interior handle to open the door.

5 Description of the driving position

b. Locking the door

- The door lock is used to hold the door open during the machine operation.

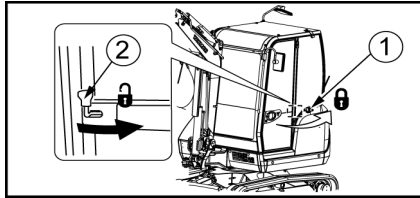

1= Cylindrical lock

2= Handle

To lock the door:

- Open the door.
- Push the door against the outer side of the cabin for engaging the cylindrical lock. **(1)**

To unlock the door:

- Pull the handle to disengage the cylindrical lock. **(2)**
- Close the door with the handle.

5.9.2 Upper windscreen

Opening of the upper part of the windscreen

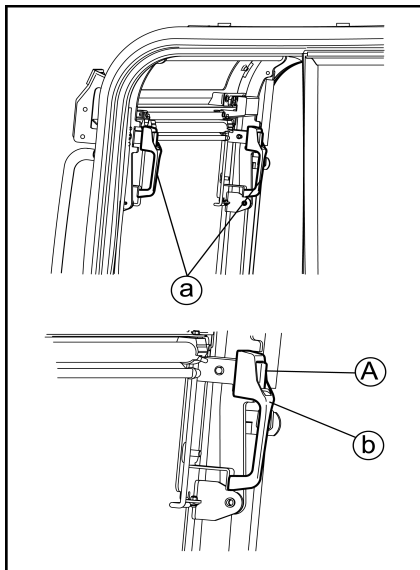

- Grasp the handles (a) and push the levers to the right and left of the window until you hear a click for them to unlock.

a = Handle

b = Push

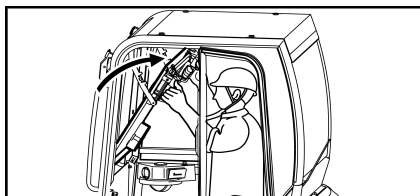

- Remount the top part of the windscreen and drag it backwards until it positions itself under the ceiling.

5 Description of the driving position

Closure of the upper part of the windscreen

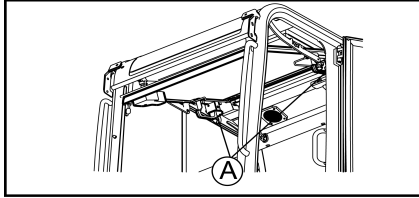

1. Take the handles (A) and press the locking buttons on the ceiling to release the upper part of the windscreen.
2. Slowly lower the windscreen holding the handles.

5.9.3 Right hand cab window

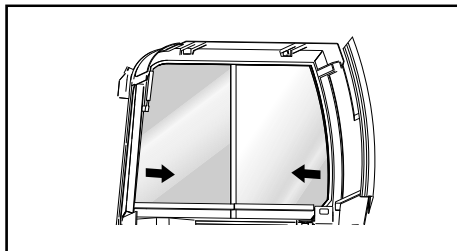

1. Open the right hand cab window by sliding it in the direction indicated by the arrows.
 2. Tighten the pressure lock to hold the window in the position you want.
 3. To close the window, loosen the pressure lock.
- A = Handle

5 Description of the driving position

5.10 Headlights

 **WARNING**

The headlight becomes very hot when it is operating. Never touch it with your bare hands before it has cooled down to avoid any risk of burning.

Boom headlamp

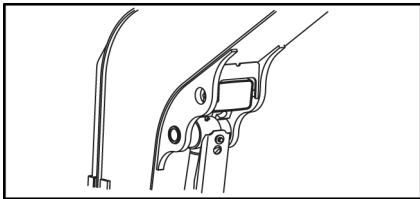

Cab headlight (*Options*)

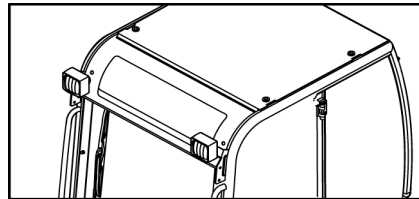

Canopy type (*Options*)

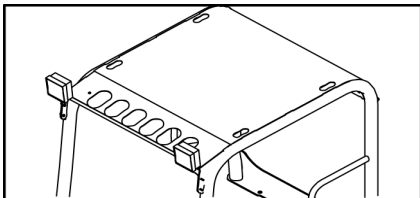

Tail light (*Options*)

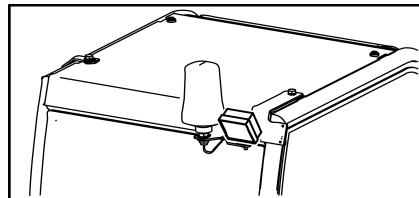

6 HEATING VALVE

If the operator wishes to ventilate the passenger cabin by stopping the heating function, do the following:

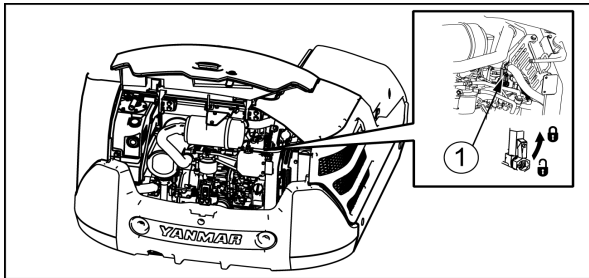

1= Heating valve

Note

To restore the heating function reverse the process.

1. Perform the machine's parking operations.

2.4.2 Stopping the engine, page 76

2. Open the bonnet with the ignition key.
3. Turn the valve in the locked position to stop the heating function.
4. Close the engine bonnet.

7 OPTIONS

- Mounting options that are not authorised by YANMAR may cause accidents and reduce the machine's life span.
- The installation and use of unauthorised parts may lead to the warranty being cancelled.

7.1 Long arm

- The machine can be fitted when this option is requested.
- Use of hydraulic hammer is not recommended with the long arm.

7.2 3rd hydraulic circuit

For the use of the 3rd circuit, refer to chapter .

5.3.3 3rd hydraulic circuit control (P.T.O. 1), page 24

Adjustable proportional PTO

- Use the proportional roller to adapt the dual effect P.T.O. rate.
- The adjustable proportionality allows better P.T.O. flow control by combining a knob with the proportional roller.

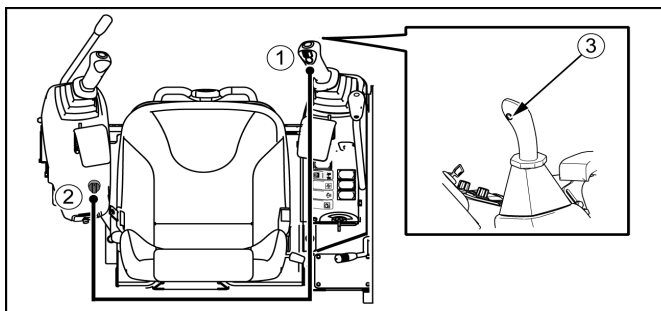

- 1= Proportional roller
2= Knob
3= Position holding button

- To use the adjustable proportionality system:
 1. Operate the accessory with the proportional roller. **(1)**
 2. Set the maximum hydraulic circuit speed with the knob. **(2)**

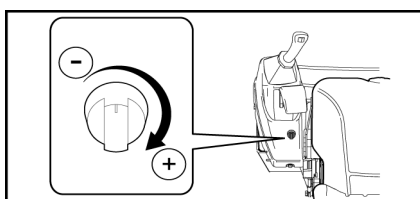

- Turn the button clockwise to increase the flow rate.
- Turn the button counter-clockwise to decrease the flow rate.

7 Options

Position holding button

To use the position holding button:

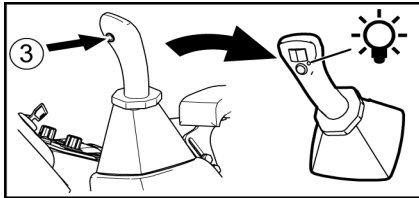

3= Position holding button

1. Operate the accessory with the proportional roller. **(1)**

2. Press the position holding button. **(3)** Release the proportional roller. **(1)**

The proportional roller control pressure is blocked and the LED on the corresponding joystick comes on.

3. The accessory operation is maintained and the accessory is operated at the rate set by the knob. **(2)**

4. Press the position holding button again to return the pressure to its starting level.

CAUTION

Do not use the position holding with bucket tilting, you would risk damaging the machine's hydraulic circuit.

7.3 PTO line 2

Use the proportional roller on the left joystick to use the accessory mounted on the PTO's second line.

PTO 2 may be associated with a knob to make it an adjustable proportional PTO line.

P.T.O. switch

- Use the proportional roller to adapt the dual effect P.T.O. rate.

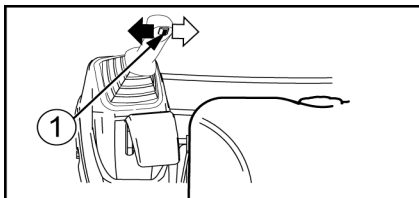

1= Proportional roller

Adjustable proportional PTO

- The adjustable proportionality allows better P.T.O flow control by combining a knob with the proportional roller.

7 Options

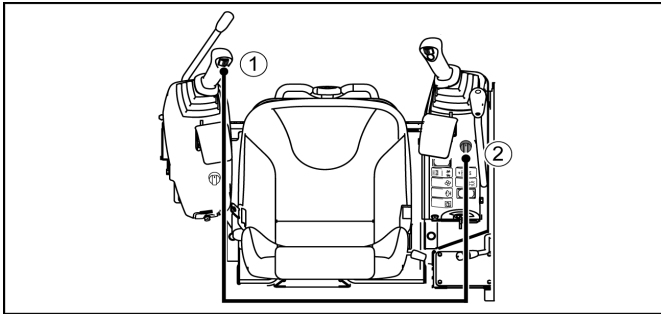

1= Proportional roller

2= Knob

- To use the adjustable proportionality system:
 1. Operate the accessory with the proportional roller.(1)
 2. Set the maximum hydraulic circuit speed with the knob. (2)

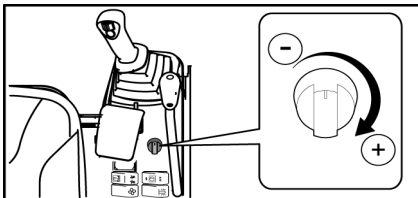

– Turn the button clockwise to increase the flow rate.

– Turn the button counter-clockwise to decrease the flow rate.

7.4 Automatic engine idle

Engine slow down switch

- Use this switch to automatically reduce engine speed.
- When the auto-idle switch is ON and the machine controls are in neutral, the engine speed is automatically reduced after 4 seconds.
- If you use the machine controls, the engine speed will automatically returns to the speed set by the engine speed knob.

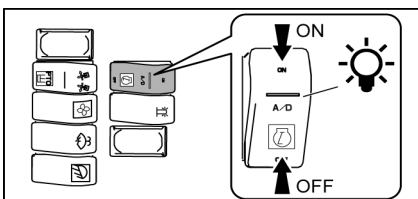

ON = Auto-idler activated The indicator light is on.

OFF = Auto-idler deactivated The light is off.

Engine rate setting

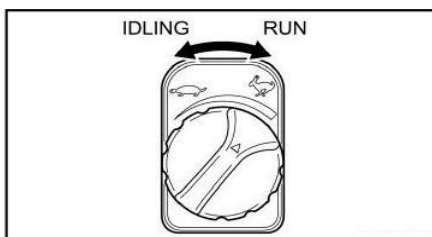

- The throttle lever is replaced by a knob on the dashboard to the right of the operator seat.

- Turn the knob to increase or decrease the engine speed.

– Turn the knob clockwise to increase the engine speed.

– Turn the knob counter-clockwise to decrease engine speed.

7 Options

7.5 Additional counterweights

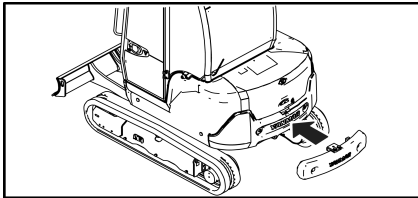

- The machine can be equipped with an additional counterweight that gives it better stability and greater lifting capacities.
- 1= Additional counterweights

7.6 Lifting Kit

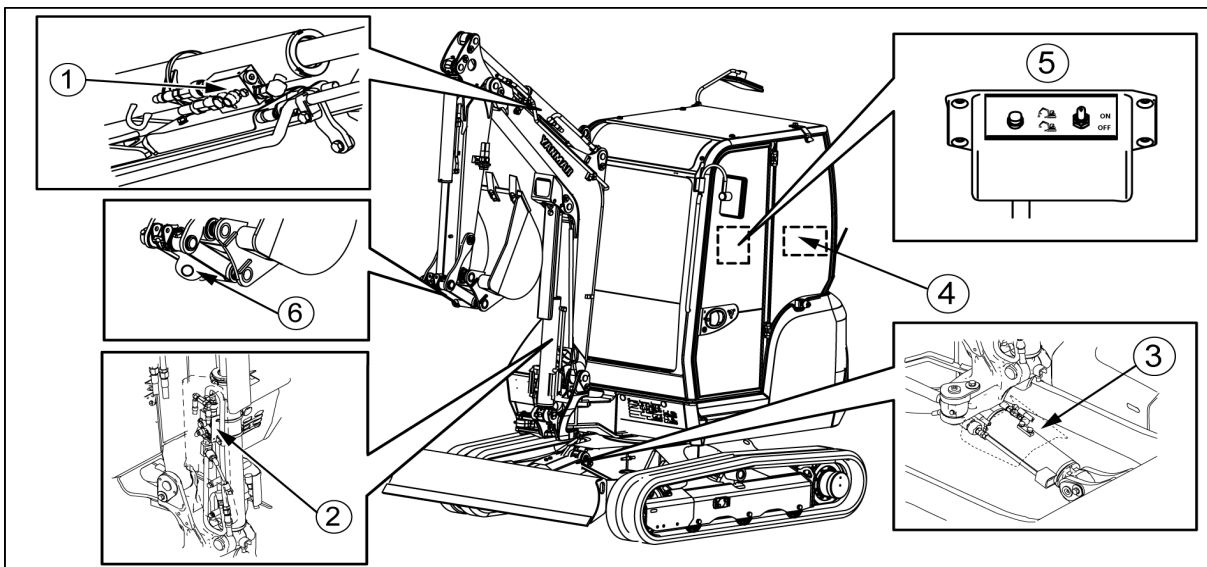

- 1= Arm valve
2= Boom valve
3= Blade valve

- 4= Lifting Tables
5= Overload box
6= Lifting ring

WARNING

Do not perform lifting operations without the lifting equipment listed below being installed on the machine.

13 Load lifting, page 111

7.6.1 Lifting ring

- An appropriate ring is required to suspend a load with the machine. For more details, contact your dealer.
- The lifting ring welded to the tie rod must be installed with safety valves.
- Check whether the ring and the ring mounting base are damaged. If you detect any damage, ask your dealer to intervene.
- This option is subject to periodic inspection.

IMPORTANT

Install a device that can oppose the accidental release of the load on the machine's lifting ring (with latch hook, shackle, eye...) and whose WLL¹ is equal to or greater than the load to be lifted.

7.6.2 Safety valves

The safety valves must be installed with the ring. These flaps are installed on the machine's boom, rocker arm and blade cylinders to avoid the equipment falling to the ground if the hoses break.

7.6.3 Overload box

- When the operator wishes to handle something, it is imperative that the overload box switch is in the ON position to inform the operator of the tipping points depending on the load being handled and the position of the equipment.
- An audible signal warns the operator that the load that he is handling is too heavy and could well topple the vehicle.
- When the audible signal sounds, the operator must promptly put the load being handled down on the ground because it could well topple the vehicle.

⚠ IMPORTANT

Activating the load indicator box does not stop the operator from making sure that the load to be handled does not exceed the value indicated on the load table.

It is forbidden to handle the loads without turning on the overload box.

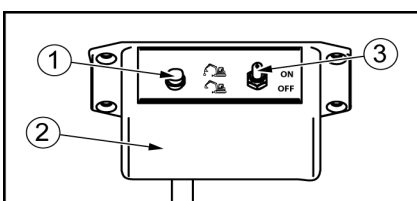

1= Green light: is on when the charge indicator is on.

2= Overload box located in the cab.

3= Switch

1. Working load limit(WLL)



7 Options

7.6.4 Lifting Tables

- A table summarizing the machine lifting capacities is provided with the safety valves.

DANGER

The board must be installed in the cab so as to be visible by the operator from the driver position while operating the machine.

Check it out before doing any load lifting.

7.7 Movement alarm

- The machine can be fitted when this option is requested.
- The travel alarm is composed of displacement sensors and a buzzer.
- When the side movement levers are pushed or pulled, the movement sensors are activated and the alarm sounds.

7.8 Protection of cylinder

- The cylinders for the arm, boom and bucket can be replaced with models equipped with a protective plate.

7.9 Plug-in flashing light

DANGER

**Keep three points of support with the machine to complete the installation safely.
If three points of stable support are not available, use suitable equipment to operate the machine safely.**

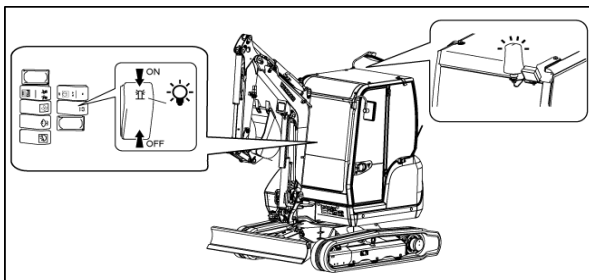

- The machine can be fitted when this option is requested.
- The beacon kit includes the beacon, its electrical harness and its support, and a mountable switch in the cockpit.

- To activate the flashing light attached to the rear of the cab, turn on the switch located in the cab on the right of the driver's seat.
- To attach the flashing light:
 1. Remove the protective cap from the pin's tip.
 2. Insert the tip of the flashing light in the pin and tighten the nut located at the base of the flashing light.

7.10 Keypad immobilizer

- The machine can be fitted when this option is requested.
- The theft deterrent keypad consists of an immobilizer box and a keypad installed in the cockpit.
- For more information, consult the instructions supplied with the device.

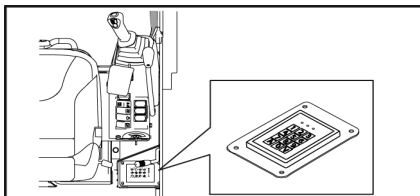

1. Once the user code has been programmed, type A, then the 4-digit code and press button V.

Note

When the code is recognised, the green light (to the left) will light up.

2. Then turn the starter key within 60 seconds.

7 Options

7.11 The immobilizer key is coded.

- The machine can be fitted when this option is requested.
- The immobilizer keypad consists of an immobilizer box and a key reader installed in the cockpit.
- For more information, consult the instructions supplied with the device.

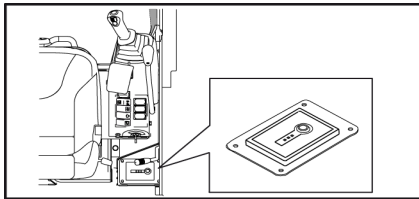

1. Pass the coded key on the key reader in the cockpit.

Note

When the code is recognised, the green light (to the left) will light up.

2. Then turn the starter key within 60 seconds.

7.12 Anti-starter with key

- The machine can be fitted when this option is requested.
- The immobilizer key consists of an immobilizer box and a key reader installed in the cockpit.
- For more information, consult the instructions supplied with the device.

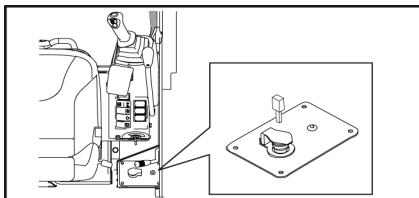

- To start the engine, insert the MED electronic key into its housing, remove it and start the engine within 30 seconds.

Note

Once the time has passed, repeat the whole procedure.

- The anti-start mechanism is triggered 30 seconds after the contact key is turned to OFF.



7.13 Fleet management system MTECH

- The ME401-2 fleet management system allows knowing the geographical position of the machines so equipped. Use of GPS functions from the box is done by sending an SMS to the GSM assigned to the machine and allows access to management services via the Trackunit web portal (available as a Smartphone application).

- The user manual can be downloaded at the following address:

<http://www.trackunit.com/en/support/download/>

⚠ DANGER

If you are wearing a Pacemaker, to avoid potential interference with your medical equipment, do not wear your cellphone on you in a machine with a ME401-2 box.

⚠ DANGER

After installation, the MTEch unit can not be turned off. Do not enter a potentially explosive area with your machine, your box may result in an explosion or fire, resulting in serious physical injury. Hazardous areas are indicated by signage on the work area; observe these to avoid any accidents.

⚠ CAUTION

The MTECH box plays regularly at a GPS satellite signal and a consumption of 20mA. If you store the machine for a long time, take the necessary precautions to keep your battery charged.

⚠ CAUTION

The ME401 box is a transmitter which transmits and receives radio waves (RF). Do not use in areas where the use of mobile phones is prohibited (hospitals, airports, mining operation area...).

- The ME401-2 unit can be coupled on your machine to an anti-theft system with a hydraulic lock or immobilizer.

7.14 Bio oil

⚠ WARNING

When working on your hydraulic system, contact your dealer.

Standard bio oil

The machine can operate with biodegradable hydraulic oil.

Panolin bio oil

The machine can operate with biodegradable hydraulic oil. Panolin. The percentage of mineral oil mixed with the bio oil must not exceed 2 %. Refer to the datasheet VDMA 24 569 of March 1994.

7 Options

7.15 Radio

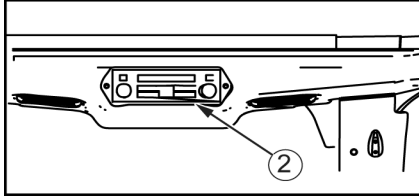

Refer to the user manual supplied with the radio.

2= Radio

7.16 Quick coupler

CAUTION

Before any connection or disconnection of the hydraulic hoses, remove the residual pressure from the hydraulic circuit.

2.1.2 Removing the residual pressure, page 131

Connecting

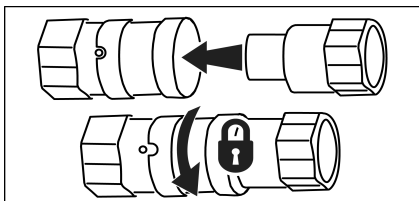

1. Insert the adapter into the receiver. A slight click indicates that the connection is successful. The ball is released from the adapter groove located on the receiver.

2. Turn the adapter on the receiver to secure the connection.

Note

Before each use, clean the receiver surfaces.

disconnecting

To disconnect, turn the adapter to align the ball with the groove located on the receiver and slide the adapter backwards.

Note

The hydraulic connection locking system may vary depending on the model fitting installed.

7.17 Centralized greasing system

- The centralised lubrication automates the greasing of the swivel pins on your machine. It comes with a timer allowing adjusting the lubrication cycle and time.
- A switch in the cockpit allows to launch the lubrication of the machine swivel points.
- To refill the centralized greasing system, connect the grease pump on the filling connector nipple (B).

 3 Recommended greases and fluids, page 137

 **CAUTION**

Do not plug the hole at the top of the tank in order not to block the filling.

 **DANGER**

In case of over filling, the tank can burst and cause physical injuries.

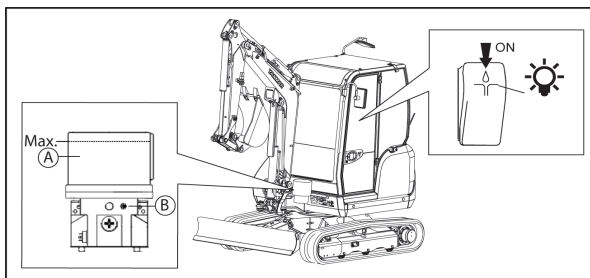

A= Tank

B= Filling connector

MAX= Filling limit

7 Options

7.18 Mechanical quick coupler

⚠ IMPORTANT

Use YANMAR original parts as recommended in the parts catalogue.

IMPORTANT

Before using an accessory requiring hydraulic power, check the pressure compatibility from the machine specifications chart.

 1 Specifications, page 165

⚠ WARNING

Before mounting a bucket or an accessory on your machine, make sure that:

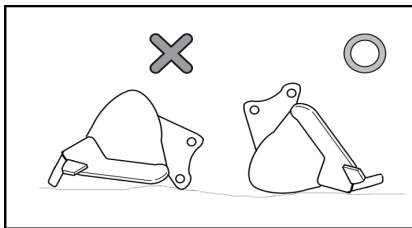

- the bucket or accessory is compatible with the capabilities of your machine;

 10.2 Compatible accessories, page 101

- the bucket or accessory mounting operation is performed on a level and stable ground;
- the bucket or accessory is properly positioned to be installed on the machine.

⚠ WARNING

Check the condition of the interface between the quick coupler and the accessory (cleanliness, shocks...).

It is forbidden to operate the bucket or accessory if improperly locked in quick coupler, because in the case of improper installation it may fall during use.

7.18.1 Mechanical quick coupler ARDEN EQUIPMENT

Quick coupler structure

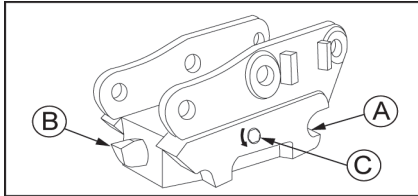

The quick change system is composed of:

A= Fastening hooks

B= Locking pins

C= Locking screw

Dismantling the accessory

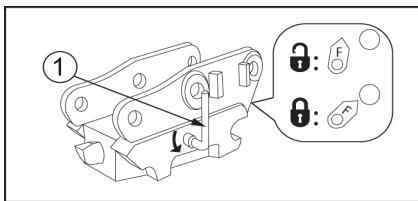
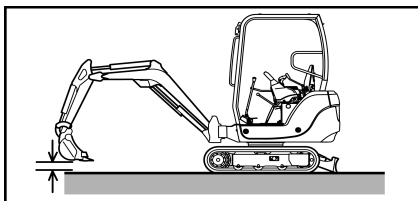

1. Park the machine preferably on a stable, flat and level surface.
2. Place the accessory at about 5 cm above the ground.
3. Be equipped with the wrench supplied with the accessory and insert it into the quick coupler hole.
4. Turn the key (1) to disengage the bucket or accessory locking pin.

⚠ DANGER

By pressing the key, the bucket or accessory detaches and comes into contact with the ground. Take care not to get your hands or feet crushed by the bucket or accessory.

5. Remove the key and store it.
6. Retract the bucket cylinder to disengage the rear of quick coupler.
7. Slowly remove the boom from the machine to completely free the quick coupler from the bucket or accessory.

Mounting the accessory

1. Place the accessory on a stable, flat surface.
2. Clean all the parts.
3. Be equipped with the wrench supplied with the accessory and insert it into the quick coupler hole.
4. Turn the key to unlock the quick coupler (1).
5. Remove the key and store it.
6. Place the arm equipped with the quick coupler on the accessory to engage the accessory hooks on the bucket or accessory pin.
7. Rotate the quick coupler slowly lifting the boom to fully engage the quick coupler to the bucket or accessory.
8. Manoeuvre the bucket or accessory to low height from the ground to see if it is locked in the quick coupler.

Note

Check that the indicator is in the locked position.

7 Options

7.18.2 Mechanical quick coupler RETROMATIC MORIN

Quick coupler structure

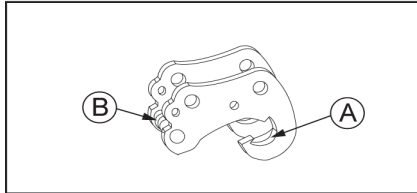

The quick change system is composed of:

A= Fastening hooks

B= Locking pins

Dismantling the accessory

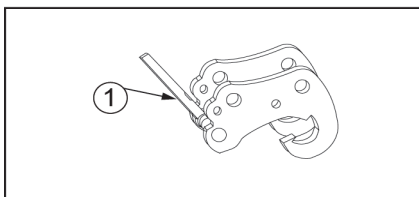
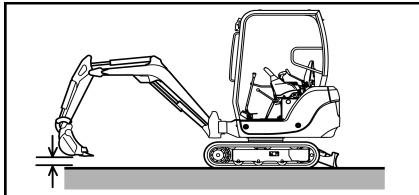

1. Park the machine preferably on a stable, flat and level surface.
2. Place the accessory at about 5 cm above the ground.
3. Be equipped with the wrench supplied with the accessory and insert it into the quick coupler hole.
4. Turn the key (1) to disengage the bucket or accessory locking pin.

DANGER

By pressing the key, the bucket or accessory detaches and comes into contact with the ground. Take care not to get your hands or feet crushed by the bucket or accessory.

5. Remove the key and store it.
6. Manoeuvre the arm to disengage the tool's quick coupler.

Mounting the accessory

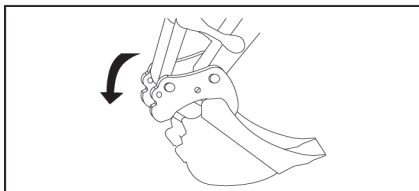

1. Place the accessory on a stable, flat surface.
2. Clean all the parts.
3. Place the arm equipped with the quick coupler on the accessory to engage the accessory hooks on the bucket or accessory pin.
4. Rotate the quick coupler by slowly lowering the boom to fully engage the quick coupler to the bucket or the accessory.
5. Manoeuvre the bucket or accessory to low height from the ground to see if it is locked in the quick coupler.

7.18.3 Mechanical quick coupler CSERI

Quick coupler structure

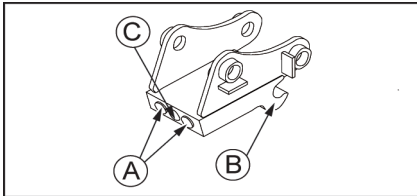

The quick change system is composed of:

- A= Locking pins
- B= Fastening hooks
- C= Locking screw

Dismantling the accessory

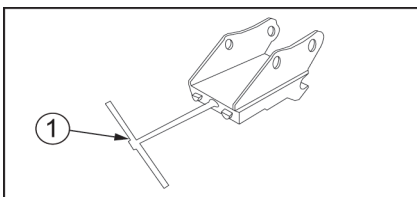
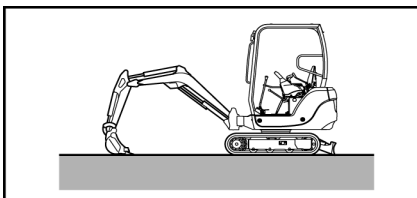

1. Park the machine preferably on a stable, flat and level surface.
2. Place the accessory on the ground.
3. Be equipped with the wrench supplied with the accessory and insert it into the quick coupler hole.
4. Turn the key (1) to disengage the bucket or accessory locking pin.
5. Remove the key and store it.
6. Retract the bucket cylinder to disengage the rear of quick coupler.
7. Slowly remove the boom from the machine to completely free the quick coupler from the bucket or accessory.

Mounting the accessory

1. Place the accessory on a stable, flat surface.
2. Clean all the parts.

Note

Make sure the locking pins are retracted into the quick coupler.

If the pins are in the extended position:

- a. Be equipped with the wrench supplied with the accessory and insert it into the quick coupler hole.
 - b. Turn the key (1) to disengage the bucket or accessory locking pin.
 - c. Remove the key and store it.
3. Place the arm equipped with the quick coupler on the accessory to engage the accessory hooks on the bucket or accessory pin.
 4. Rotate the quick coupler slowly lifting the boom to fully engage the quick coupler to the bucket or accessory.
 5. Manoeuvre the bucket or accessory to low height from the ground to see if it is locked in the quick coupler.

7 Options

7.19 Quick hydraulic attachment CSERI

⚠ WARNING

Before mounting a bucket or an accessory on your machine, make sure that:

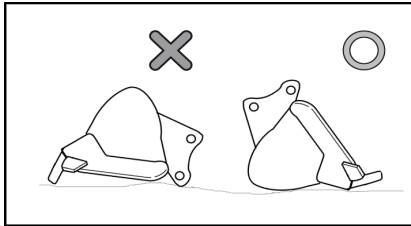

- the bucket or accessory is compatible with the capabilities of your machine;
- the bucket or accessory mounting operation is performed on a level and stable ground;
- the bucket or accessory is properly positioned to be installed on the machine.

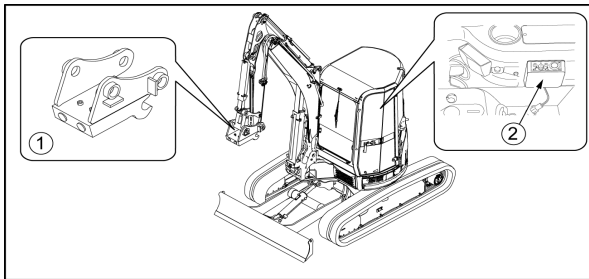

- 1= Quick hydraulic attachment
- 2= Quick attachment control unit

Quick hydraulic attachment

- When the locking pins retract, a indicator pin is visible in the quick coupler.
- When the locking pins are removed, the indicator pin retracts and is no longer visible.

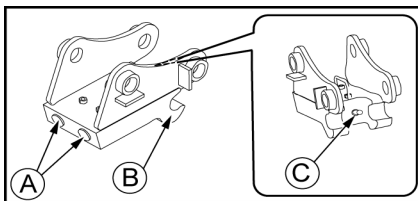

- A= Locking pins
- B= Fastening hooks
- C= Indicator pin

Quick attachment control unit

- Use the control box located in the cab to install or remove a bucket or an accessory.

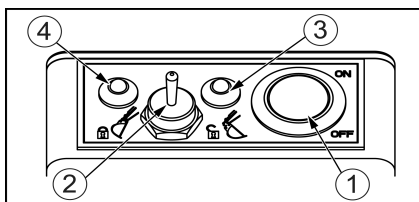

- 1= Power supply contact
- 2= Lock switch
- 3= Light : Quick coupler unlocked (red)
- 4= Light : Quick coupler locked (green)

7.19.1 Dismantling the accessory

1. Park the machine preferably on a stable, flat and level surface.
2. Place the accessory on the ground.

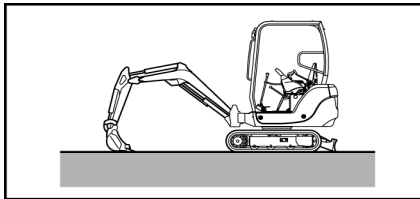

3. Turn the switch (1) to ON.

The contactor switch indicator lights and the alarm sounds.

⚠ WARNING

If the warning light does not come on or if the alarm does not sound, stop the current operation and contact your dealer.

4. Hold switch (2) in the locked position until the locking pins are completely retracted.
The green light comes on. The control rod is visible (C).
5. Take the boom to disengage the accessory hooks on the bucket pin or accessory.
6. Move the quick attachment away from the accessory.
7. Turn the switch (1) to OFF.
The light goes off and the alarm stops.

7.19.2 Mounting the accessory

1. Turn the switch (1) to ON.

The contactor switch indicator lights and the alarm sounds.

⚠ WARNING

If the warning light does not come on or if the alarm does not sound, stop the current operation and contact your dealer.

2. Hold switch (2) in the locked position until the locking pins are completely released.
The green light comes on. The control rod is not visible.

⚠ WARNING

Do not perform this step if the control rod is visible. You might damage the control rod engaging the quick coupler to the bucket or accessory.



7 Options

3. Place the arm equipped with the quick coupler on the accessory to engage the accessory hooks on the bucket or accessory pin.

4. Hold switch (2) in the locked position until the locking pins are completely retracted.

The green light comes on. The control rod is visible (C).

5. Rotate the quick coupler slowly lifting the boom to fully engage the quick coupler to the bucket or accessory.

The control rod must be visible from the driving position.

6. Hold switch (2) in the locked position until the locking pins are completely released.

Note

The locking pins engage on the bucket or accessory to lock it.

The green light comes on. The control rod is not visible.

DANGER

Make sure that the control rod is retracted into the quick coupler and is no longer visible. Otherwise check the condition of the interface between the quick coupler and the accessory (cleanliness, shock...).

It is forbidden to operate the bucket or the accessory if the control rod is still visible, because in this case it is not installed on the machine and it may drop during use.

7. Manoeuvre the bucket or accessory to low height from the ground to see if it is locked in the quick coupler.

8. Turn the switch (1) to OFF.

The light goes off and the alarm stops.

WARNING

For safety reasons, do not work with the machine until the power switch is in the OFF position.

8 COVERS

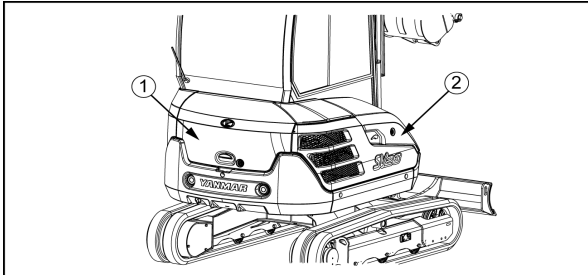

- 1 = Bonnet
- 2 = Cover B

8.1 Bonnet

- The filling ports for the hydraulic oil tanks, engine oil, and coolant are under the bonnet.

WARNING

Do not open the bonnet during machine operation. Verification and topping off of the various levels should be done when the engine is stopped and the temperatures are brought back down.

Opening the cover

1. Insert the starter key into the lock.
2. Turn the key anti-clockwise.
3. Pull the lever to unlock the safety mechanism. The cover opens.

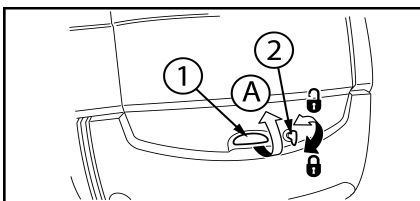

- 1 = Exterior handle
- 2 = Key
- A = Pull

Closing the cover

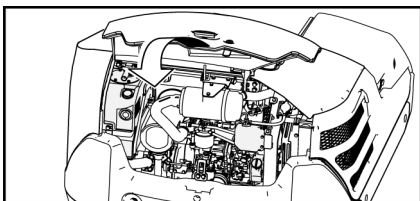

1. Close the cover.
2. Press on it until you hear a click.
3. Turn the key clockwise to activate the lock.

8 Covers

8.2 Cover B

- The fill port for the fuel tank, battery and battery switch are under bonnet B.

Opening the cover

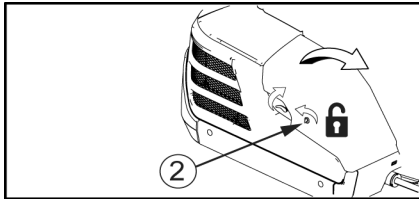

1. Insert the starter key into the lock. (2)
2. Turn the key anti-clockwise.
3. Pull the lever to unlock the safety mechanism. The cover opens.
4. Lock the cover using the rod.

Closing the cover

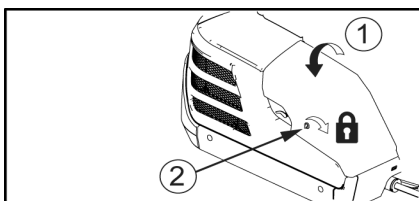

1. Lift the cover slightly and press the rod to release it.
2. Close the cover. (1)
3. Turn the key clockwise to activate the lock. (2)

8.3 Circuit breaker

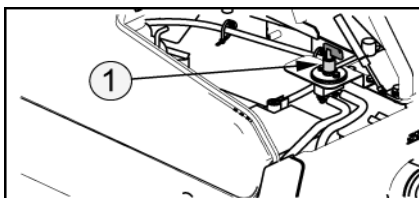

This switch is used to disconnect the battery directly.

1 = Circuit breaker



B Operating instructions

CHAPTERS COVERED IN THIS CHAPTER:

- 1 BASIC PRECAUTIONS
- 2 USAGE PRECAUTIONS
- 3 PRECAUTIONS FOR THE ENGINE
- 4 CHECKS BEFORE STARTING THE MACHINE
- 5 CHECKS AFTER START-UP
- 6 CHECKS AFTER USE
- 7 OPERATOR LCD DISPLAY STATION INTERFACES
- 8 USING THE MACHINE IN COLD WEATHER
- 9 RUBBER TRACKS
- 10 HANDLING THE BUCKET
- 11 HANDLING OF ACCESSORIES
- 12 ACCESSORY CHANGE BY DIRECT COUPLING
- 13 LOAD LIFTING
- 14 IMPLEMENTING THE 3RD HYDRAULIC CIRCUIT
- 15 TRANSPORTING THE MACHINE
- 16 DETECTING ANOMALIES
- 17 IF THE BATTERY IS DISCHARGED
- 18 TOWING THE MACHINE



1 BASIC PRECAUTIONS

⚠ CAUTION

The user must determine whether dangerous phenomena may occur in an application, for example, the release of toxic gases, or whether the ground conditions require specific precautions. The user establish the measures to be taken to eliminate or reduce the risks.

1.1 Comply with your workplace's safety rules

- This machine must only be used and maintained by qualified personnel.
- When using or maintaining the machine, comply with all safety rules, precautions and procedures at all times.
- Any task performed in teams or with a flagman should be performed based on regulatory signals.

⚠ DANGER

The machines are not designed to work in explosive or polluted environments.

The machine configuration can not guarantee the safety of the operator in a harmful environment and thus the machine must not be used in such environments.

1.2 Put the safety mechanisms in place

- Make sure that all covers and all housings are properly installed in their respective positions. If any of them are damaged, repair them immediately.
- The use of safety mechanisms, such as locking lever(s) must be mastered and understood by the machine's operator. Operating the locking lever(s)

 **5.3.1 Locking lever, page 23**

- Never remove the safety mechanisms. Check that they are operating correctly at all times. If the safety mechanisms are operating incorrectly this may cause serious physical injury.

1.3 Wear suitable clothing and protective equipment

- Never wear bulky clothing or jewellery that may be caught in the control levers or a part of the machine. Also avoid wearing soiled work clothes, which can be risky when using the machine.
- Wear a helmet, protective goggles, safety shoes, a mask, gloves and any other protective equipment necessary to suit the working conditions.

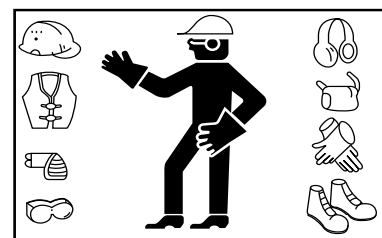

1 Basic precautions

1.4 Do not drive under the influence of alcohol, drugs or medication.

- Never use the machine if you are under the influence of alcohol, if you are ill or if you do not feel well as this may cause an accident.

1.5 Provide adequate ventilation when working in an enclosed space

- The engine exhaust fumes are harmful to the human body and it is very dangerous to inhale them. When you start the engine in an enclosed space, open the windows and doors to let air circulate.
- Never let the engine idle unnecessarily and never leave the engine running when you are not using the machine.
- Provide respirators based on working conditions to ensure the machine operator works safely.

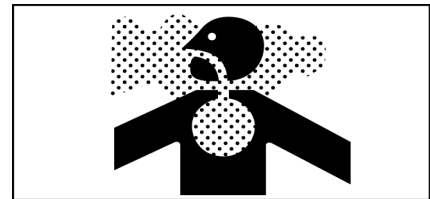

1.6 Protect plants from hot air and exhaust fumes

- The silencer and radiator release hot air and exhaust fumes at high temperatures. If the hot air directly reaches a plant, it alters its state and may cause its death.
- Protect plants from hot air and exhaust fumes with a protective plate when you are working near a hedge or plants.

1.7 Keep fuel and oil away from sparks

- Leaving flames near fuel, oil, hydraulic oil or anti-freeze solutions, which are highly flammable and dangerous, may cause a fire.
- Specific attention must be paid to the following points :
 - Keep flammable materials away from cigarettes, lit matches or any source of fire.
 - Never top up any fluids while the engine is running. Do not smoke when topping up any fluids.
 - Tighten the fuel and oil tank caps firmly.
- Store fuel and oil in a cool, well-ventilated place away from direct sunlight.
- The fuel and oil must be stored in a place that responds to applicable safety regulations. Unauthorised personnel must not enter this area.



1 Basic precautions

1.8 Avoid removing the caps when the temperatures are high

- The engine coolant is hot and under pressure after stopping the machine.
- The removal of the cap or draining the coolant in such conditions may cause burns.



- When you remove the radiator cap, shut down the engine and let the coolant cool down enough then gently turn the cap to release all the pressure.



1.9 Have an extinguisher and a first aid kit

- The workplace must be equipped with an extinguisher. Read the instructions on the adhesive labels to find out how to use it.
- Place a first aid kit in a specific location.
- Specify the action to be carried out in the event of a fire or accident.
- Indicate the person to be contacted in the event of an emergency and leave the emergency call number near your telephone.
- A location to install an extinguisher is provided inside the machine's cab.

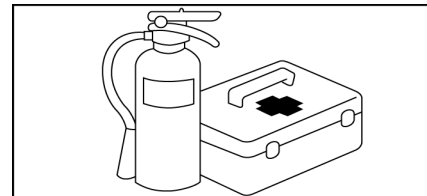
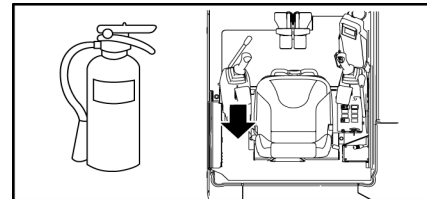

1.10 Avoid any unauthorised modifications

Any unauthorised modification to the design or use of unauthorised accessories may cause physical damage. YANMAR cannot be held responsible for any physical injuries, accidents, failure or damage to the machine due to any unauthorised modifications.

In addition, in that these actions would constitute an explicit violation of the terms of the YANMAR Product Warranty, the applicable warranty would also become null and void. If you want to modify your machine, you must contact your dealer.

1 Basic precautions

1.11 Precautions for optional parts and tools

- Any modifications that are not approved by YANMAR may cause safety risks.
- If the equipment you want to add to your machine is not listed by YANMAR, you must contact your dealer. YANMAR cannot be held responsible for any physical injuries, accidents, failure or damage to the machine due to any unauthorised modifications. Any unauthorised modification will lead to the YANMAR warranty being cancelled.
- When you install or use optional accessories, read their operating instructions and the section in the manual that relates to the installation of accessories. When you install or use optional accessories, read their operating instructions and the section in the manual that relates to the installation of accessories.

12 Accessory change by direct coupling, page 107

- Only use accessories authorised by YANMAR. The use of unauthorised accessories risks affecting not only the safety of the machine but also its operation or life span.
- The use of unauthorised equipment will contravene the terms of the YANMAR warranty and cancel it.

1.12 Warning concerning the cab windows

- If, by accident, a cab window is broken, the sharp edges may represent a danger to the operator. Stop the machine immediately and replace the broken window with a new one.

1.13 Cabin's emergency exit

- The emergency hammer is to the left of the operator seat. Use it to break the emergency exit glass if you are unable to exit the cab through the door or through the cab windows.
- The emergency exit is indicated by a safety sticker.
- Remove the pieces of glass that remain in the window frame to avoid any cutting risk.
- Make sure that you do not slip on the pieces of glass that have fallen at your feet on the cab floor.

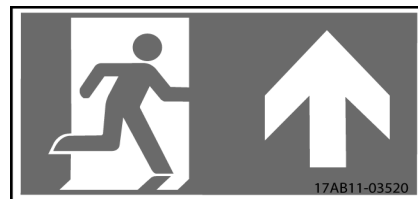

2 USAGE PRECAUTIONS

2.1 Precautions before starting the engine

2.1.1 Make sure that your workplace is safe

- Before you start the engine, make sure that there is no danger in your working area.

If there are any underground installations such as water or gas pipes, high voltage lines or other elements, contact the companies responsible to locate them exactly and to avoid damaging them.

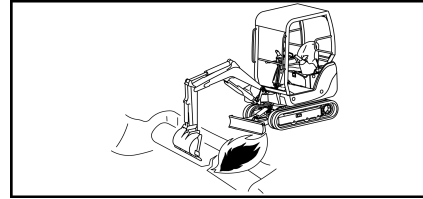

- Examine the field and the ground and decide on the best way to work.
- When working on the street, make sure the worksite is secure.
- If you have to use the machine under specific conditions (water, snow, etc.)

 **2.3.7 Working in an area covered with snow, page 73**

2.1.2 Clean the machine

Cleaning

- Wood chips, dead leaves, detritus and other flammable materials around the engine may catch fire. Clean these materials from the machine.



- Dirt, oil and snow on the cab floor, the levers, handles or steps are slippy and dangerous. Clean them completely.
- Proceed to the checks:

 **4 Checks before starting the machine, page 80**

2 Usage precautions

Keep the headlights and mirrors clean

- To clean the cab exterior:

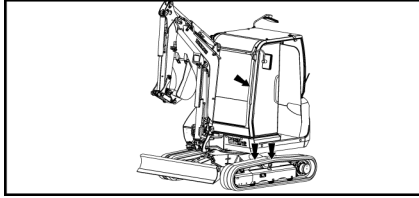

- Be sure to keep three points of support with the machine when cleaning the external elements (e.g. mirrors).
 - Use the support points identified in the illustration opposite.
 - If 3 points of stable support are not accessible for cleaning or maintenance of the external elements, use adapted equipment in order to safely work on the machine.
- Check that your machine is fitted with headlights and specific working lamps and that they are working correctly.

WARNING

The projector becomes very hot when it is working. Never touch it with bare hands until it has cooled down to avoid any risk of burning.

2.1.3 Check the safety structures

- The standard machine is equipped with a Falling Objects Protection Structure (FOPS) on the machine's roof.
- The protection structures mounted on the machine comply with the recommendations of ISO 12117-2 of 2008 (ROPS) and 10262 of 2000 (FOPS).

For the specifications of these structures, refer to the table below:

Type	Cabin ROPS / TOPS
Weight (in conformity with CE standards) kg	3100

- For your safety, the machine includes a protection structure in the event of it turning over (ROPS), for protection against falling objects (FOPS) and protection against side tipping (TOPS). Never modify any of these structures' elements.
- If one of the safety structures is damaged, have it replaced immediately to avoid any injury. Do not repair or modify it.

2 Usage precautions

2.1.4 Check the position of the blade

- Check the position of the blade before operating the side movement levers. When the blade is at the back, the operation of the side movement levers is reversed.

Normal travel

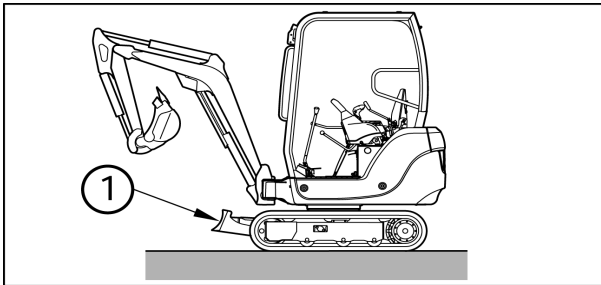

1 = Blade

Reverse slide movement

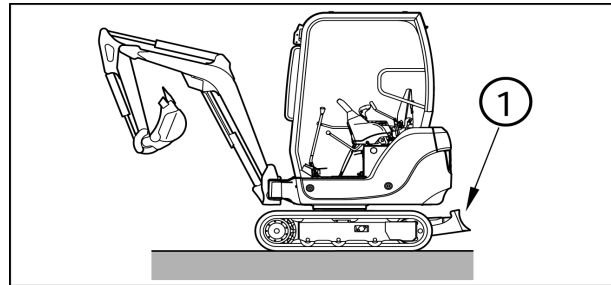

1 = Blade

2.1.5 Accessing the machine

- Do not jump on or out of the machine. Do not climb into or out of the machine when it is operating as this may cause physical injuries.
- When you enter and leave the machine, face the machine and use the handles and the top of the track.

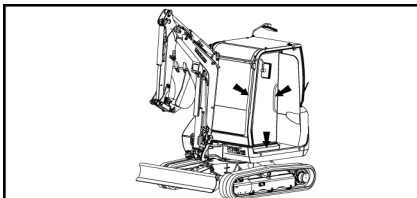

- Use the contact points indicated by arrows in the illustration opposite to climb onto and descend from the machine.
- Do not use the command levers as handles.
- Always maintain three points of contact.
- If the handles or the track is dirty or covered with oil, wash them off.

CAUTION

Make sure that you do not bang your head against the rearview mirror when you climb into or out of the cab.

2 Usage precautions

2.1.6 Fasten your safety belt and adjust the rearview mirror(s)

- The operator's seat is fitted with a safety belt.
- Always fasten your safety belt and adjust it before starting the machine.



WARNING

The seat belt must be replaced after an accident or if it is damaged.

- The seat and its support must be checked by your dealer after an accident.
- If the seat and/or its support are damaged they must be replaced immediately.
- Adjust the rearview mirror(s) so that you have perfect visibility around the machine.

2.2 Movement precautions

2.2.1 Machine's Danger Zone

DANGER

The operator must manipulate the machine controls from the operator seat. Any use of the machine controls from the ground is strictly prohibited because it can lead to physical injury.

WARNING

Start the engine and run the machine only from the operator seat.

- A signaller must be provided when the working site is dangerous or has poor visibility.
- Keep all other people away from the working site or movement route of the machine.
- Keep any other persons out of the danger zone represented by the equipment's operating radius.

Equipment operating range= 5m

- Alert people nearby using the horn or any other signal before starting the machine.

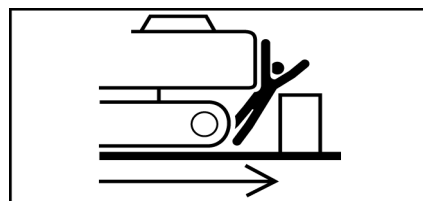
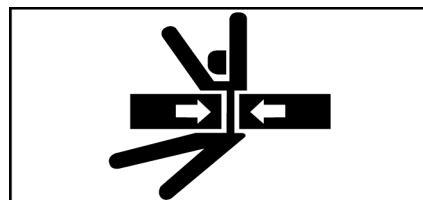

DANGER

If a person is in the machine's danger zone, it may be struck by the machine's moving parts or be wedged between the machine's lower and upper parts, which can result in serious injury or death.

2 Usage precautions

2.2.2 Movement and accessories

- When moving the machine, keep the bucket between 40 and 50 cm above the ground with the boom and arm folded.
- If you need to use the command levers when moving, do not make any sudden movements when operating them.
- Move the machine at low speed and slow down when turning on hilly terrain.
- Avoid driving over obstacles if possible. Avoid them or remove them. If this is not possible, drive the machine at low speed keeping the tool near the ground. Never travel over obstacles that risk tilting the machine by over 10 degrees.

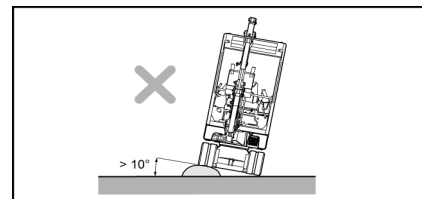
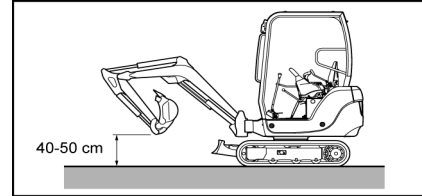

2.2.3 Driving the machine on a slope

- Drive the machine carefully on a slope to avoid any tipping over or slipping to the side.
- When driving the machine on a slope, keep the bucket between 20 and 30 cm above the ground to be able to lower it to the ground and stop the machine in the event of an emergency.

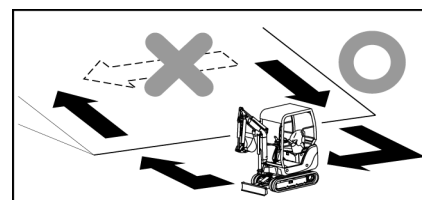
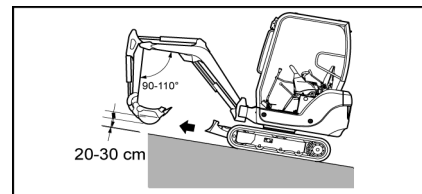
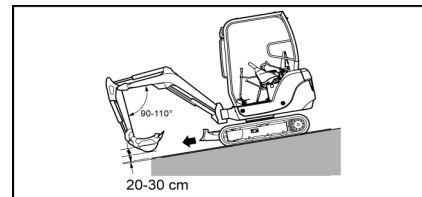

WARNING

Never travel across a slope of 20° or more as the machine may tip over.

- Never turn the machine on a slope and do not move it across a slope. Descend to flat ground and then turn.

Note

For the maximum acceptable slope:

1 Specifications, page 165

- The machine will slide easily on grass, dead leaves or a damp metal plate, even with a slight tilt. Drive the machine carefully at low speed to prevent it slipping.

WARNING

The machine may lose its balance and tip over when rotating the upper part or when the equipment is working on a slope.

Do not pivot the upper structure with a load in the bucket. If the rotation cannot be avoided, provide a bank to keep the machine as horizontal as possible. Then turn the upper structure.



2 Usage precautions

Braking when descending on a slope

- When going downhill, you can automatically stop the machine by putting the travel levers in neutral.

If the track slides

- If the tracks slide and you can not climb a slope with the travel motors alone, plant the bucket into the ground, retract the arm and move forward. Repeat this operation as many times as necessary.

If the engine stops

- If the engine stops when climbing an incline, position the travel levers in the neutral position and lift the locking lever, then stop the machine and restart the engine. If the machine does not start, pull the locking lever and check the fuel level.

2 Usage precautions

2.3 Working precautions

2.3.1 Precautions for using the equipment

⚠ WARNING

Do not use the equipment's command levers during side movement. Stop the side movement then use the equipment.

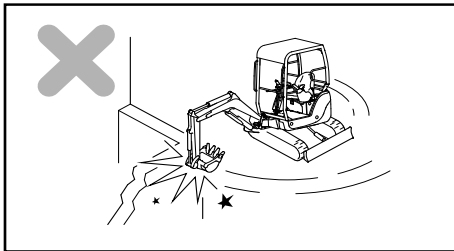

- **Do not use the equipment's rotation force.**

Do not use the rotation force to level the ground or break a wall. Do not use the bucket's teeth to dig the ground during rotation. This may damage the equipment.

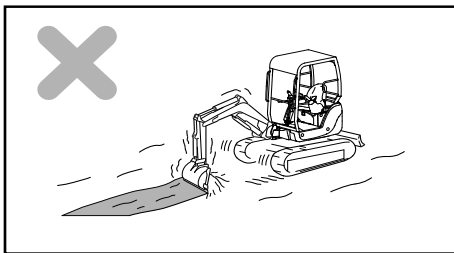

- **Do not use the equipment's side movement force (except where unavoidable).**

Do not use the side movement force to dig the ground with the bucket's teeth in contact with the ground. This may apply excessive force to the rear of the machine and shorten its life span.

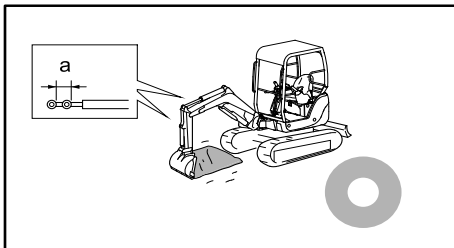

- **Do not use the hydraulic cylinder to the end of its run.**

a = play

This may apply excessive force to the cylinder's stop piece and may reduce the equipment's life span. Maintain safe room for manoeuvre.

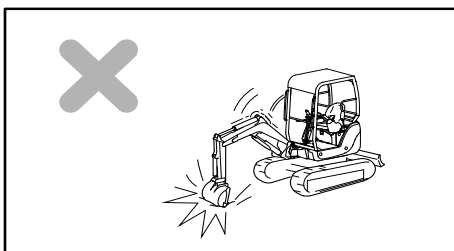

- **Do not use the bucket's dropping force.**

Do not use the bucket's dropping force to dig the ground as with a pick or harvester. This may apply excessive force to the rear of the machine and shorten its life span. In addition, this may cause a serious accident.

2 Usage precautions

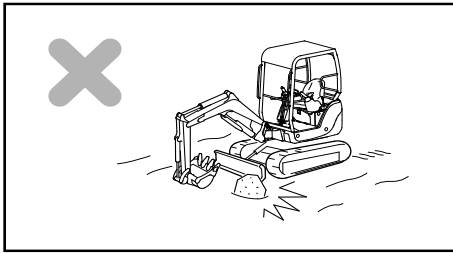

- **Do not strike the blade against a rock or stone.**

This may damage the blade or hydraulic cylinder.

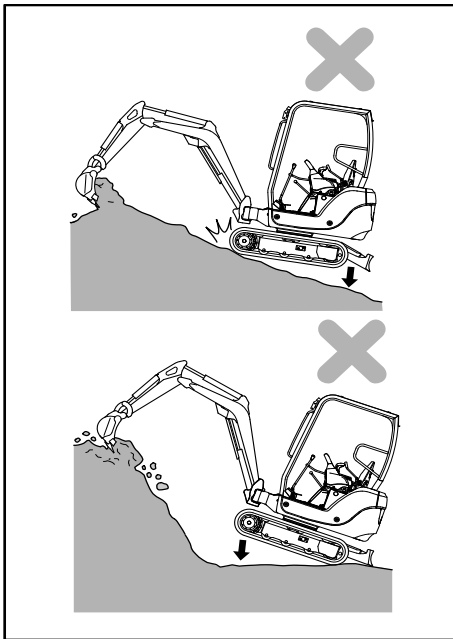

- **Do not use the machine's lowering force.**

Note

Do not use the machine's lowering force to dig the ground.

- **When excavating a hard rock, keep the machine's tracks flat on the ground.**

Note

It is also recommended to break hard rock into several pieces using other means to prevent damage to the machine.

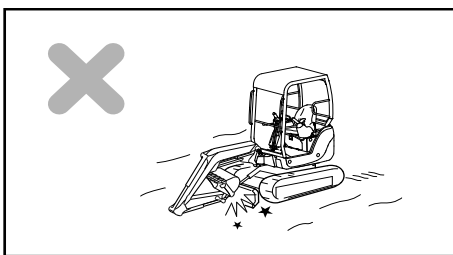

- **Be careful when pulling the equipment out.**

When you retract the equipment for side movement and transport, make sure that the bucket and blade do not come into contact.

2 Usage precautions

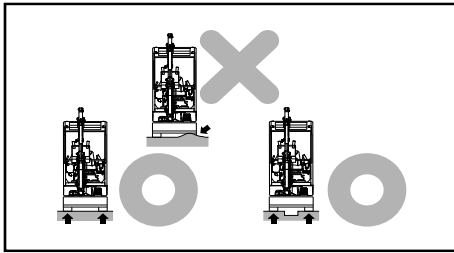

- **Support the blade on both sides.**

When you use the blade as a support, press the blade down on both sides.

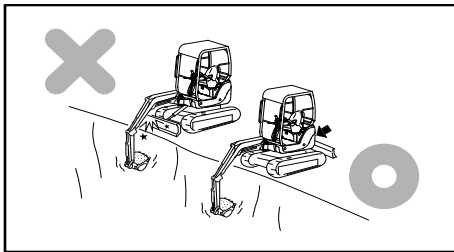

- **Pay attention to the blade during excavation.**

When carrying out a deep excavation on the ground in front of the blade, make sure that the blade does not come into contact with the boom cylinder. Place the blade at the back if it is not in use.

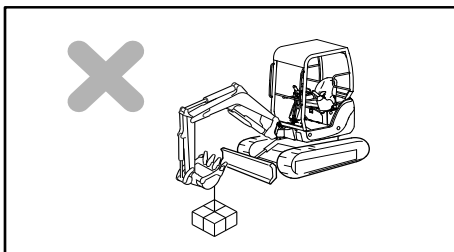

- **Do not lift loads without a suitable fastening device; it is strictly forbidden to wrap a sling around your machine's accessory or suspend it to a bucket tooth.**

13 Load lifting, page 111

2.3.2 Dangerous tasks

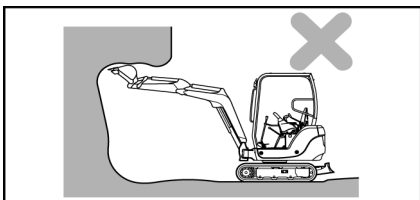

- Digging from the top is dangerous as there is a risk of rock falls or landslides.

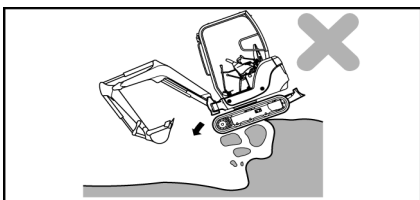

- Digging from the bottom is dangerous as this may destabilise and tip over the machine.

2 Usage precautions

2.3.3 Working near electricity lines

⚠ DANGER

Working close to overhead electricity lines is very dangerous and specific precautions must be taken.

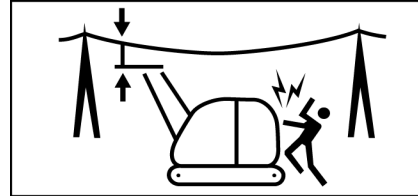

- For this manual, you are considered as working near overhead electricity lines once the equipment or your machine's load can reach the minimum distances indicated in the table below.
- Follow these procedures to prevent any accident or injury :
 - Wear shoes with rubber or leather soles.
 - Use a signaller to warn the operator when the machine is too close to an electrical line.
 - If the machine is to enter into contact with a cable, the operator must not leave his seat.
 - Warn all personnel on the ground to stay far enough away from the machine.
- To determine the voltage of the wires on the work site, contact the electricity production company concerned.

	Voltage (V)	Minimum safety distance (m)
Transformer	≤ 100/200	2
	≤ 6600	2
Transmission line	≤ 22000	3
	≤ 66000	4
	≤ 154000	5
	≤ 275000	7

2.3.4 Working near obstacles

- When moving in a tunnel, under a bridge or when you are working in an area near tall obstacles, drive the machine carefully to avoid knocking the boom, the arm or the accessory against these obstacles.

2.3.5 Emergency stop and securing the machine

In case of an emergency stop of the machine, immediately put the accessory or load being handled on the ground according to the following procedure:

In case of hose rupture or imminent dangerous phenomenon due to loss of control of the machine, release the machine controls and immediately lift the safety lever. The machine's power circuits are cut, except the one controlling the blade.

Note

If necessary, move the ignition key to OFF to stop the engine.

2 Usage precautions

1. Lower the lock lever.
2. Set the starter key to ON position.
3. Use the joysticks to lower the boom and place the accessory or load on the ground.
4. Raise the lock lever.
5. Turn the key to OFF position to switch off the engine and disconnect the electrical circuit. Remove the key from the ignition.

2.3.6 Working on a slope

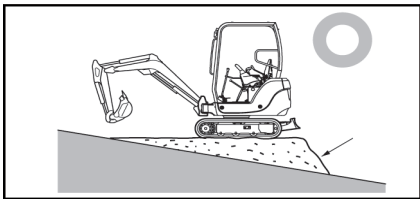
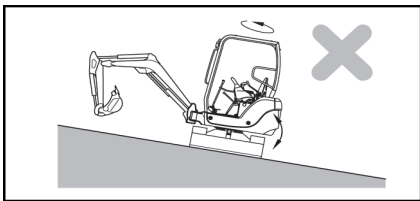

- Make sure that the machine does not lose its balance and tip over when rotating the upper structure or when rotating equipment on a slope.
- Do not pivot the upper structure with a load in the bucket.
- If the rotation cannot be avoided, provide a bank to keep the machine as horizontal as possible. Then turn the upper structure.

Note

For the maximum acceptable slope: :

1 Specifications, page 165

2.3.7 Working in an area covered with snow

- Ground covered with snow and icy roads are dangerous as the machine may slip, even on a slight incline. Drive the machine at reduced speed; do not stop or turn suddenly.
- Remove the snow carefully as verges or other potential dangers may be buried beneath the snow.

2 Usage precautions

2.3.8 Working on unstable ground

WARNING

Unstable ground increase the risks of the machine tipping over.

- Keep away from cliffs, verges and ditches as the ground there is unstable. There is a risk that it will give way because of the machine's vibrations or weight, which would cause the machine to tip over or fall. Be careful when working immediately after rainfall or an explosion as the ground is unstable.
- Infill and ground near trenches are not stable and risk giving way because of the weight or vibrations of the machine, which would cause the machine to tip over or fall. Be especially carefully when working on this type of ground.
- When you are working in an area with a high risk of rock fall, wear a helmet and remain under the canopy or in the cab.

2.3.9 Working in a submerged area

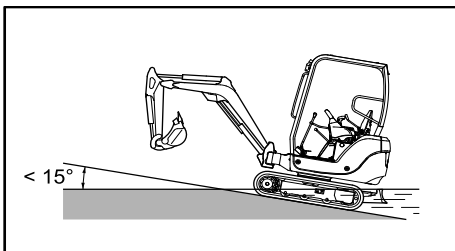
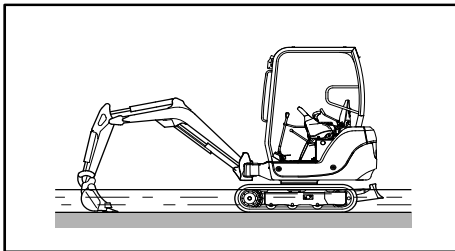

- Before you use the machine in a submerged area, examine the condition of the ground and the depth and flow of the water.
- The maximum depth of water in which the machine may be used is located up to the centre of the carrying roll.

IMPORTANT

When you come out of the water, if the machine is climbing a slope with an angle of over 15°, there is a risk that the rear of the upper structure will remain submerged in the water, which risks damaging the radiator when it stirs up the water. Be aware of this when you exit the water.

- After use, apply a large quantity of grease to the moving parts (in particular the bucket pin) which have been submerged in water for a long period until the grease used is extruded from the bearings.
- Then wipe off the extruded grease with a cloth.

2 Usage precautions

2.3.10 Working in a muddy area

- Operate the machine carefully so that it does not get stuck. If it does get stuck, release it using the following procedures.

If only one track is stuck

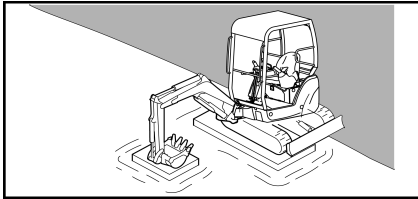

1. Place the bucket on the muddy side.
2. Lift the track.
3. Place wood or a wedge under the track runners.
4. Raise the bucket.

IMPORTANT

When you raise the machine, support yourself on the ground with the lower part of the bucket (and not with the teeth). The angle between the boom and the arm must be 90° to 110°.

If both tracks are stuck

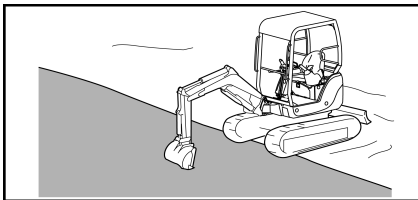

1. Place a log or piece of wood under the tracks.
2. Push the bucket into the firm ground.
3. Retract the arm as if to dig and move forward with the side movement levers to get out of the mud.

2.3.11 Working in an area with reduced visibility

- When working in a dimly-lit area, switch on the lights and front headlights and provide additional lighting if necessary.
- Stop all work when fog, snow or rain hinders your visibility.

2 Usage precautions

2.4 Parking precautions

2.4.1 Parking location

- Park the machine preferably on a stable, flat and level surface.
- If you need to park on a slope:
 1. Verify that the ground offers sufficient stability over time to maintain the machine position.
 2. Place the blade on the side of the slope and plant it in the ground.
 3. Place the bucket opposite the blade and plant it also in the ground.
 4. If you can not follow this procedure, add a wooden wedge on the uphill side of the slope at the tracks.

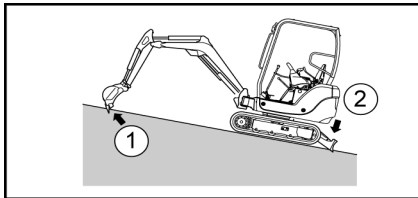

- 1 = Bucket in the ground
2 = Blade in the ground

2.4.2 Stopping the engine

1. Release the right and left side movement levers in neutral position to stop the machine.
2. Run the engine on idle with the accelerator lever.

IMPORTANT

Stopping the engine after a rotation at high speed risks reducing its life span. Do not stop the engine suddenly except in an emergency.

If the engine is overheating, do not stop it immediately. Reduce the engine temperature progressively by running it at an intermediate rotation speed before stopping it.

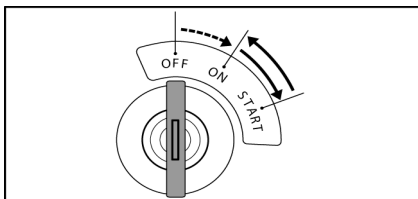
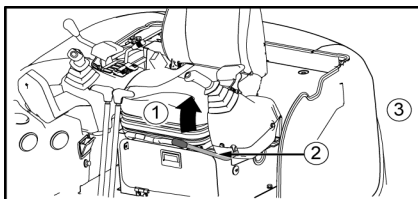
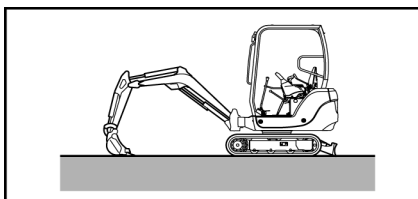

3. Lower the bucket to place its lower surface in contact with the ground.
4. Lower the blade to the ground.

5. Pull the locking levers back.

- 1 = Locking
2 = Locking lever
3 = Left hand side

6. Turn the key to OFF position to switch off the engine and disconnect the electrical circuit.

7. Remove the key from the ignition.

WARNING

Do not touch the command levers before switching off the engine, or else the equipment or the machine may move suddenly and cause a serious accident.



2 Usage precautions

2.5 Precautions for the accessories

CAUTION

An accessory that is not adapted to the machine may imbalance it.

- When you mount or remove an accessory, follow these precautions :
 1. Place the machine on flat, firm ground.
 2. Stop the engine.
 3. Keep the parts clean and well greased.
 4. Never mount any accessories that exceed the maximum accepted dimensions.
 5. Do not stay beneath a suspended load.
- The user must read and keep the instructions related to mounting and using accessories.

2.6 Precautions for using optional accessories

- An accessory that is very long may imbalance the machine and cause it to tip over when it descends a slope or pivots on a slope.

2.2.3 Driving the machine on a slope, page 67

2.3.6 Working on a slope, page 73

- If you mount a particularly heavy accessory on the machine, the inertia of the upper structure will increase and continue to rotate over a long distance once the rotation lever has been released.
- This may give the operator a false impression of the distance to be respected between the pivoting accessory and a nearby object and may strike the accessory against the object. To avoid this type of accident, stop the rotation as soon as possible.
- Because of the increase in the inertia, the accessory will fall a greater distance away after it has been stopped in the air. There will be major unplanned drift for the accessory.
- Check that the arm and the boom are correctly mounted. If this is not the case, accidents or damage may occur. Contact your dealer if you have any questions relating to mounting the boom or the arm.
- If you mount a long accessory, you may incorrectly estimate the distance between the accessory and a nearby object and strike the accessory against the object. Provide enough room between the long accessories and the nearby objects.

2 Usage precautions

2.7 Precautions for the battery

- The battery is located under cover B.

DANGER

Be careful when handling the battery.

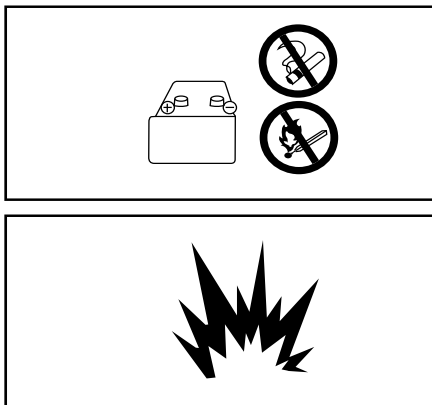

- The battery electrolyte can cause severe burns to the eyes or skin. Always wear safety glasses and clothes when handling the battery.
- If the battery electrolyte comes into contact with your skin or clothes, rinse it off immediately in a large quantity of water and consult a doctor.
- An explosion may occur as the hydrogen produced by the battery is flammable. Keep the battery away from all flames and sparks.

- If you accidentally swallow any of the battery's electrolyte, drink a large quantity of water, milk or fresh eggs and consult a doctor immediately.
- Before inspecting or handling the battery, switch off the engine and turn the starter switch to OFF.
- Make sure that you do not cause a short circuit by touching the battery terminals with a tool.
- If a terminal connection comes loose, sparks may be caused because of a poor contact and may cause an explosion. Make sure that the terminals are connected safely.

CAUTION

To start the engine using the connection cables, comply with the procedure described

 **17 If the battery is discharged, page 123**



3 PRECAUTIONS FOR THE ENGINE

- It is vital that you respect a running in period for the machine during the first hundred hours of service (read the time counter). During this period, the machine must not be used with an excessive load, even though it has been correctly prepared and checked before despatch. Otherwise there is a risk that its performance will be affected and its life span shortened.
- When running in the machine, make sure to :
 - Preheat the engine by running it on idle for 5 minutes after starting it.
 - Do not run the machine with a heavy load or at a high speed.
 - Do not start, accelerate or stop the engine suddenly.
 - Do not change direction too suddenly.

Note

Observe these precautions throughout the life of the machine in order to preserve the good condition of the engine.

4 CHECKS BEFORE STARTING THE MACHINE

4.1 Overall visual inspection

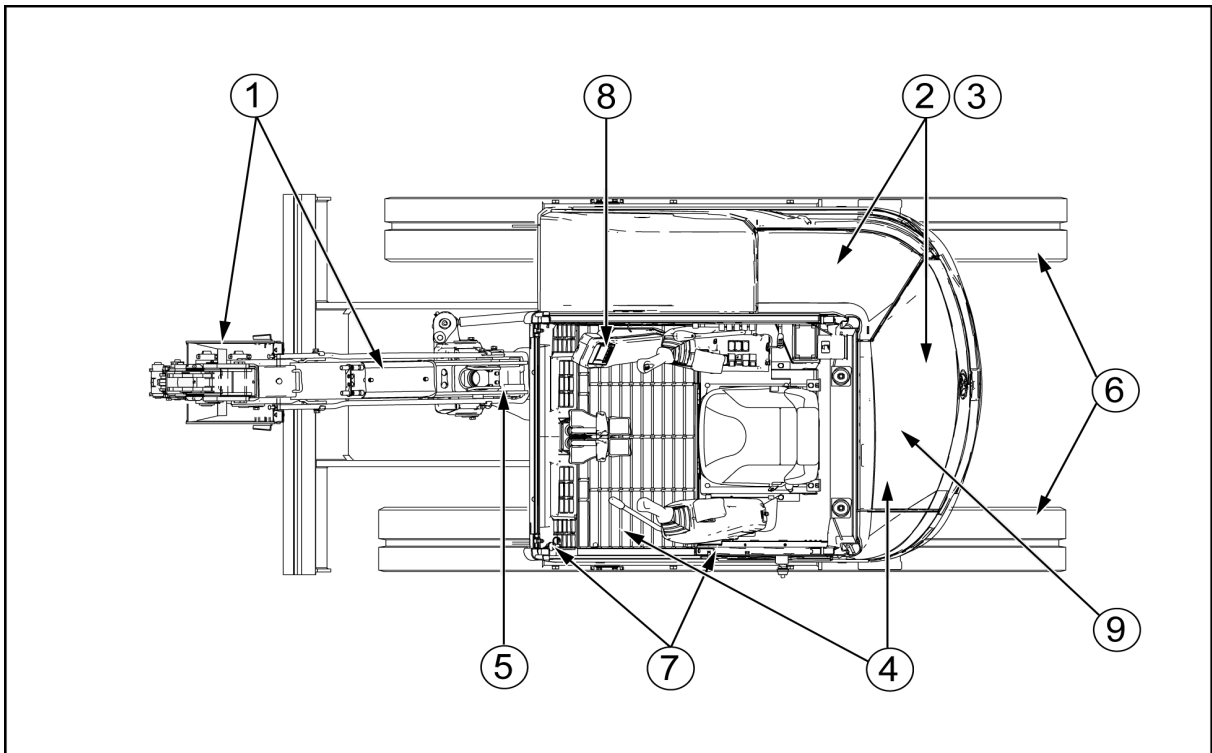

⚠ WARNING

If there is any fuel on hot areas or if there are any fuel and/or oil leaks, this may cause a fire. Carefully check these possible causes of fire. If there are any faults, contact your dealer.

1	Check the hydraulic components : wear and leaks around the cylinders, damage to the hoses and connectors come loose.
2	Clean the dust and combustible materials (dead leaves, chips) on areas where heat develops : around the engine, the battery and the radiator.
3	Check that there are no oil leaks from the engine or water leaks from the cooling system.
4	Check that there are no oil leaks from the hydraulic system, the hydraulic oil tank, the pipes and seals.
5	Check that there are no traces of grease or leaks from the hydraulic pipes.
6	Check that there are no brakes, wear or play on the bolts and there are no oil leaks on the track rollers (runners, sprockets and rollers).
7	Check that the bolts have not broken or come loose.

4 Checks before starting the machine

8	<p>Check the proper operation and the condition of the operator display station.</p> <ul style="list-style-type: none"> • If nuts are loose, tighten them if necessary. • If the screen is damaged, replace it with a new operator display station. • Clean the surface of the operator display station.
9	<p>Check that the red ring on the water decantor is pushed onto the lower part of the bowl. If the ring floats in the bowl, the means that water has mixed with the diesel. In this case, take out the bowl and remove the water.</p>

4.2 Checking and topping up the level of cooling fluid

- Check the level of cooling fluid every day according to the following procedure :
 1. Place the machine on flat ground.
 2. Stop the engine.
 3. Wait until the engine and the radiator have cooled down.
 4. Open the bonnet with the ignition key.
 5. Check that the level of fluid in the tank is between the min and max markers.

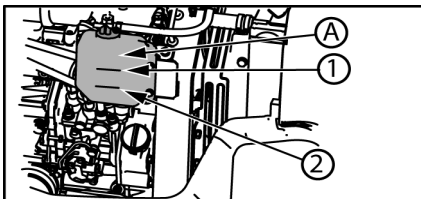

A = expansion flask
1 = maxi
2 = mini

- If the level is below the min marker:
 1. Take the cap off the tank.
 2. Top up to the maximum marker.
 3. Close the tank again.
 4. Close the engine bonnet.

IMPORTANT

If the tank is empty, check for leaks and the water level in the radiator. If the level of water in the radiator is low, top it up in the radiator then in the tank.

WARNING

Only remove the radiator cap to top up the radiator.

Replacing the cooling fluid :

The cooling fluid must be changed every 1000 hours. Contact your dealer.

Note

For any top off or replacement of the fluid, use the original YANMAR long life coolant.

4 Checks before starting the machine

4.3 Checking and topping up the engine oil level

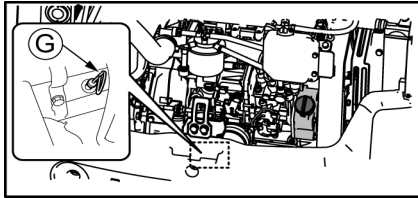

1. Wait until the engine has cooled down.
2. Open the bonnet with the ignition key.
3. Read the engine oil gauge. (G)

WARNING

At operating temperature, the oil and the gauge area are hot.

Avoid the hot oil or the components coming into contact with your skin to avoid any physical injuries.

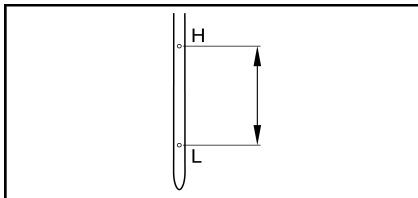

4. Clean the gauge with a cloth to remove any oil deposits.
5. Insert the gauge into its tube.
6. Remove it. The engine oil level must be between markers H and L.

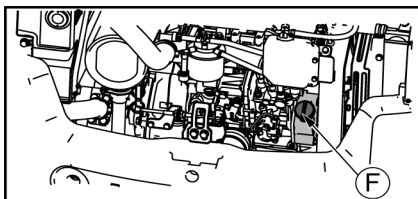

- If the oil level is below marker L, open the filling hole and top up to marker H.

F = Filler hole

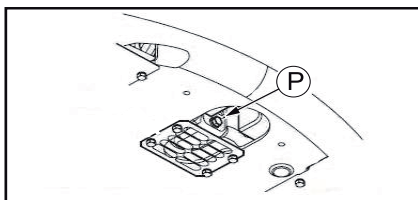

- If the oil level is above marker H, remove the excess quantity of oil via the drainage cap (P) then check the level again.

Note

Do not pour the excess engine oil onto the ground or the road.

- Once the engine oil is at the appropriate level, close the bonnet again.
- Select the oil according to the temperature. If you start the engine at temperatures below 0°C, use an SAE 10W, an SAE 10W-30 or SAE 15W-40 even though the daytime temperature rises to 10°C.

	Temperatures °C								Quantity prescribed (L)	
	-	-20	-10	0	10	20	30	+		
En- gine oil	SAE 10W CD								3,7 + 0,4	Oil filter
	SAE 10W-30CD									
	SAE 15W-40 CD									

IMPORTANT

Do not mix different types of oils. If you need to top up the oil with a different make or type from the oil left in the tank, remove the remaining oil completely.

4 Checks before starting the machine

Replacing the engine oil :

- The first time, the engine oil must be replaced after 50 hours' use of the machine. Then, it must be replaced every 500 hours. Contact your dealer.

4.4 Checking and topping up the fuel level

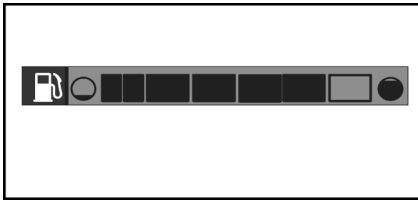

- = Full
- = Empty

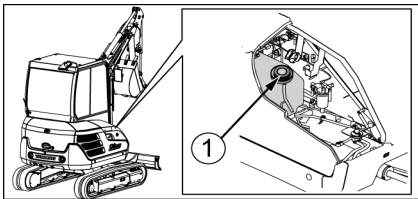

1 = Cap

Only use the recommended diesel :

- ISO 8217 DMX
- EN 590:96

Minimum cetane index: 45.

1. Set the starter key to ON position.
2. Determine the fuel level by looking at the fuel gauge on the dashboard.
3. Set the starter key to OFF position.
4. Top up if the level is low.
 - a. Open cover B using the starter key.
 - b. Take the cap off the tank.
 - c. Top up through the filler hole, keeping an eye on the gauge located on the tank.

	Temperatures °C								Quantity prescribed (L)
	-	-20	-10	0	10	20	30	+	
Diesel					N° 2-D				38,5
					N° 3-D				
					N° 3-D (S)				

⚠ WARNING

If you spill any fuel, wipe it up with a cloth.



4 Checks before starting the machine

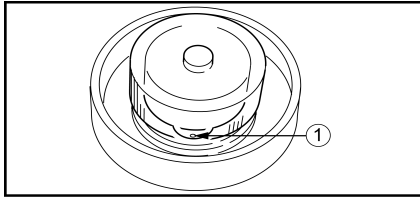

1= Event

5. Close the tank again.
6. Close cover B.

Note

If the cap vent holes are plugged, the pressure in the reservoir may vary and the fuel supply will be faulty. To avoid this happening, clean these vents air holes regularly.

4 Checks before starting the machine

4.5 Checking and topping up the hydraulic oil level

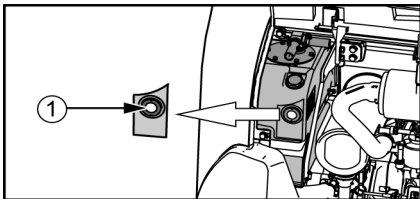
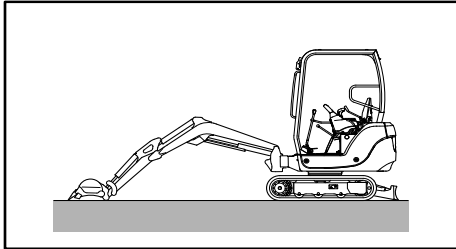

1 = Upper limit

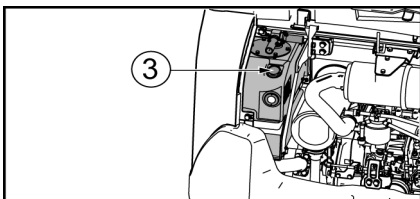

3 = Filler hole

1. Put the machine in the position shown opposite: blade back and lowered to the ground, equipment parallel to the tracks, boom cylinder half out, arm cylinder retracted to the end of its run, bucket teeth on the ground.
2. Stop the engine.
3. Determine the oil level by looking at the hydraulic tank gauge. The level should be visible in the tank bulls-eye.

Note

The oil level varies according to the oil temperature.

- Before start-up, the oil level must be on or around the central point of the gauge scale (oil temperature : 10 to 30°C).
- During normal operation, the oil level must be around the upper limit marker on the oil gauge scale (oil temperature : 50 to 80°C).

4. If the oil level is below the minimum marker, top up as follows :
 - a. Open the rear bonnet.
 - b. Open the hydraulic oil tank opening cap.
 - c. Top up through the filler hole, keeping an eye on the gauge located on the tank.
5. Close the tank again.
6. Close the engine bonnet.

IMPORTANT

Do not top the hydraulic oil over the upper limit marker on the oil level gauge. An excessive quantity of hydraulic fluid may damage the hydraulic system by applying too much pressure to these components, which would cause a dangerous high pressure leak.

	Temperatures °C								Quantity prescribed (L)
	-	-20	-10	0	10	20	30	+	
Hydraulic oil	ISO VG46								25,2 in the tank
									4,8 the rest

IMPORTANT

Do not mix different types of oils. If you need to top up the oil with a different make or type from the oil left in the tank, remove the remaining oil completely.



4 Checks before starting the machine

Replacing the hydraulic oil :

- The hydraulic oil must be replaced every 1000 hours. Contact your dealer.

5 CHECKS AFTER START -UP

⚠ WARNING

Emergency stop : if an abnormal action occurs, turn the key in the ignition switch to the OFF position. The electrical system is interrupted and the engine stops. Ask your dealer to check the machine.

IMPORTANT

The hydraulic oil must be at a temperature from 50°C to 80°C. If the temperature is low, wait until it reaches 20°C before using the equipment. If you need to use a command lever before the oil reaches this temperature, handle it gently.

Do not accelerate suddenly if the engine is not hot.

After the engine starts, do not use the machine immediately but respect the following procedure :

1. Run the engine on idle and check that the engine oil pressure alarm light is off.
2. Check that the gauges and the screen correspond to the following statuses :

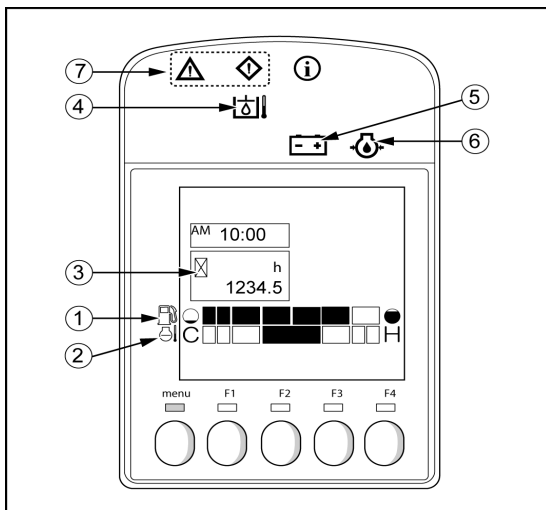

1= Diesel gauge	normal
2= Cooling fluid temperature indicator	normal
3= Time counter	normal
4= Hydraulic oil temperature gauge	off
5= Battery charge warning alert	off
6= Engine oil pressure alert indicator	off
7= Warning light & Alert light	off

3. Pull the throttle lever to the centre point between idle and full throttle. Run the engine about 5 minutes with no load at the intermediate rotational speed.
4. Unlock the locking levers and lift the bucket from the ground.



5 Checks after start-up

5. Use the joysticks to extend and retract the bucket and arm cylinders to the end of their run. Alternately run the bucket cylinder for 30 seconds then the arm cylinder for 30 seconds over a total duration of around 5 minutes to raise the hydraulic oil temperature to at least 20°C.

IMPORTANT

When moving the accessory, make sure it does not hit the ground or the machine.

IMPORTANT

Check that there is no abnormal noise in the hydraulic circuit.

6. Check the colour of the exhaust gas, the noise and the vibrations of the machine.
7. Raise the locking lever to ensure that no handling of the equipment and no rotation of the upper structure is possible with the joysticks.
8. Unlock the locking lever and activate the joysticks to check that everything is operating normally.
9. If you observe the slightest anomaly during this procedure, contact your dealer.



6 CHECKS AFTER USE

If the machine is used in a rocky place :

- Check for damage to the lower chassis.

If the machine is used in a dusty place :

- Check whether the air filter is clogged.
- Check the air filter cartridge regularly.
- Check whether the radiator vents are clogged.
- Clean or replace the fuel filter cartridge regularly.
- Clean the electrical equipment, particularly the starter and the alternator to avoid any dust deposits.

If the machine is used in mud, snow or sand :

- Clean the machine.
- Check there are no cracks or damage.
- Check that no nuts or screws are missing.
- Apply grease to all equipment axes that have been submerged in mud, snow or sand.

7 OPERATOR LCD DISPLAY STATION INTERFACES

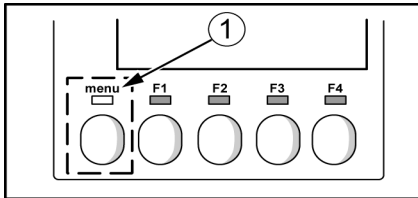

1= Menu change

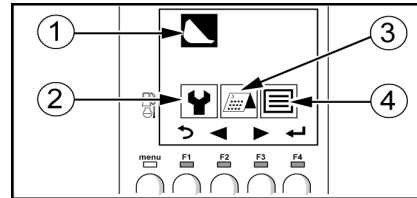

1= User Interface

2= Maintenance interface

3= Machine usage management interface

4= Configuration interface

1. Press the "Menu Change" button to access the main menu.
 2. Move the selection with the navigation keys F2 and F3 on the icon to select (◀▶)
- The colour of the selected icon is reversed (the icon background becomes black) and it is displayed above the other icons.
3. Confirm the selection by pressing F4 (↵)

7.1 Indication of functions

This section of the menu indicates the functions of buttons F1 to F4.

Return to previous menu.	(R) Reset the selected value.
Move the cursor over the object to the left of the one selected.	Displays the details of an information notice (maintenance notice for example).
Move the cursor over the object to the right of the one selected.	Stop the buzzer that sounds when a problem arises.
Move the cursor over the object above the one selected.	Select an object or validate a parameter.
Move the cursor over the object below the one selected.	Increase the selected value by 1

7 operator LCD display station interfaces

7.2 User Interface

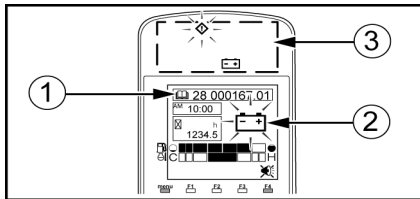

- 1= Error Code
- 2= Error Icon
- 3= Indicator lights

- The user interface displays the machine use information (hour meter, fuel gauge) and information after a failure (error code and error icon).

- In case of malfunction, the visual indicator LED lights up, the error code is displayed with the icon and the buzzer sounds.

A List of error codes displayed on the operator display station, page 174

- For more information about the information displayed on the monitor

5.1.1 Indicator lights, page 14

7.3 Maintenance interface

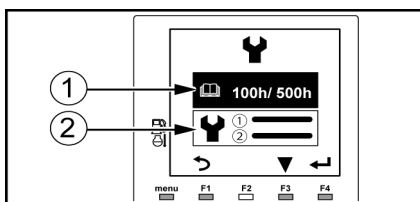

- 1= Displays the maintenance interval screen
- 2= Displays the maintenance history screen

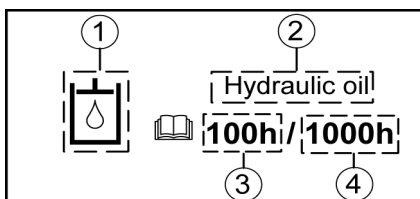

- 1= Maintenance object icon
- 2= Maintenance object name
- 3= Time accumulated since the previous maintenance
- 4= Maintenance interval

- This interface allows you to check the maintenance periods and cumulative elapsed time since the last maintenance for each maintenance object.

- Information icon appears on the screen indicating that the maintenance period for an object has been reached.

IMPORTANT

The maintenance time accumulator must be reset after the maintenance is performed.

- The date, duration and number of hours indicated on the hour meter are recorded in the maintenance history.

7 operator LCD display station interfaces

7.4 Machine usage management interface

- This interface allows you to check the machine hours of operation over a period of 90 days.

Hours of machine use for the selected month:

- The number of operating hours is shown approximately by a number of chips under the corresponding date and a time span:

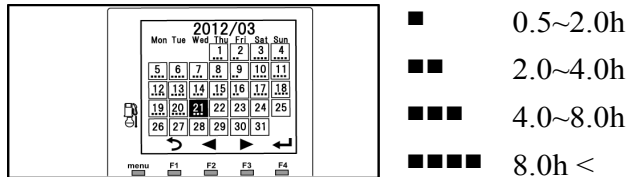

Hours of machine use for the selected day:

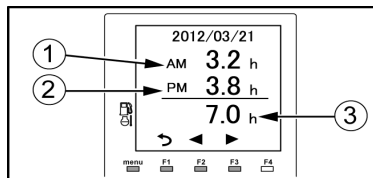

The hours of machine operation are displayed as follows:

- 1= Number of hours in the morning.
- 2= Number of hours in the afternoon.
- 3= Total operating hours for the day.

7.5 Configuration interface

This interface allows you to change the settings shown in the table below.

	<p>Language: Changes the language used by the various interfaces.</p>
	<p>Date and time setting: If the battery in the machine is removed, the date and time settings will be reset.</p>
	<p>Sound parameter: Adjusts the monitor to emit a confirmation sound when a button is pressed. The buzzer sounds when the settings are changed or when a malfunction is detected can not be removed.</p>
	<p>Brightness setting: Adjusts the brightness of LED visual indicators and the LCD screen when the work light is in operation.</p>

8 USING THE MACHINE IN COLD WEATHER

8.1 Preparation for use in cold weather

- In cold weather, you may have difficulty starting the engine because the coolant and fuel can be frozen.
- Consequently, take the following measures :
 1. Use oil and fuel suitable for the outside temperature.

 **3 Recommended greases and fluids, page 137**

2. Keep the battery charged. In cold weather, remove the battery after using the machine and store it in a heated room to facilitate restarting the machine.

8.2 Starting in cold weather

WARNING

Consult these pages and respect these safety instructions before starting up the machine.

 **2.1 Precautions before starting the engine, page 63**

1. Pull the acceleration lever back to full gas position.

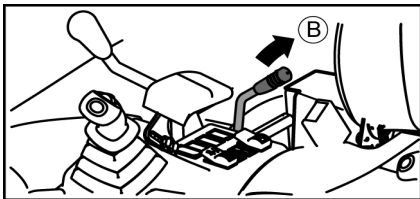

B= Throttle lever

2. Turn the key to the ON position.
 - a. Keep the key in the ON position to warm up the engine until the "warm-up" icon no longer appears on the screen.
 - b. When the glow plug icon no longer appears on the screen, turn the key to the START position to start the engine.
 - c. Release the key after the engine starts and it will return itself to ON position.
3. When the engine speed increases, move the throttle switch to the idle position.

IMPORTANT

Do not leave the key in START position for over 10 seconds.

If the engine does not start, position the key at OFF. Wait 30 seconds then restart the engine.

Moving or operating the machine without warming it up first may affect its performance.



8 Using the machine in cold weather

8.3 Precautions after use

To avoid that the machine is jammed due to mud, water or frozen deposits on the rubber tracks :

1. Remove the mud or water stuck to the machine.
2. Make sure the cylinder rods are clean to prevent damage to the seals.
3. Park the machine on firm, dry ground or place boards on the ground and park the machine on these boards to avoid the tracks freezing on the ground.
4. Drain the water built up in the fuel system by turning the evacuation tap to avoid and freezing.
5. Cover the battery or place it in a warm place and reinstall it on the machine the next morning.

8.4 When cold weather is over

- When the exterior temperature increases, replace the greasing oil and the fuel

 **3 Recommended greases and fluids, page 137**



9 RUBBER TRACKS

9.1 Correct use of rubber tracks

- Rubber tracks have certain advantages over steel tracks. However, you cannot get the full benefit out of rubber tracks if you use them in the same way as steel tracks.
- Use the rubber tracks moderately according to the conditions at the work site and the type of work.

9.2 Comparison between rubber tracks / steel tracks

	Rubber	steel
Low vibrations	◇	□
Gentle side movement (does not jerk)	◇	○
Silent side movement	◇	□
Less damage to the ground	◇	□
Simple operation	◇	□
Resistance	□	◇
Traction power	◇	◇

◇ = excellent

○ = good

□ = ordinary

- The rubber tracks have certain advantages that are inherent to the material's unique properties. It is essential that you perfectly understand the properties of the rubber tracks and comply with the handling and operating precautions for these tracks to extend their life span and get the most out of them.

9.3 Rubber track warranty

- The rubber tracks are not guaranteed for repair and replacement if they are damaged following careless use by the user : lack of check of the track tension or incorrect maintenance, use of the tracks on surfaces or terrain likely to damage them.

9.4 Precautions for using rubber tracks

- Do not use them or pivot them on broken stones, a hard, rough rock base or around steel or iron rods or the edges of iron plates. The tracks may be damaged if these precautions are not respected.
- Do not use the machine on rocky ground such as a river bed as there is a risk that the tracks will be damaged by gravel entering the runners or the tracks becoming loose. Pushing earth by force will reduce the tracks' life span.

9 Rubber tracks

- Avoid the rubber becoming stained by oil, fuel or chemical solvents. If the tracks are dirty, wipe them immediately. Do not travel across oily surfaces.
- When you do not use the machine for a period of over 3 months, avoid placing the tracks in a place that is directly exposed to sunlight or rain.
- Never drive on heated surfaces such as fires in the open air, a steel plate exposed to the sun or a hot asphalt road.
- Never drive on a track when the other track is held above the ground with the equipment. This may damage the tracks or cause them to come off.
- Never turn on the spot on concrete or asphalt roads.
- Do not suddenly change the speed. You risk wearing or damaging the track.
- Never rotate on ground with a significant difference in level. Climb a step at a right angle to avoid the tracks coming off.
- Gently lower a machine that has been raised from the ground with the equipment.
- We do not recommend that you use the machine to handle materials that become oily once crushed (soya, wheat grains, compressed colza oil yeast, etc.). After use, clean the machine fully with water.
- We do not recommend that you use the machine to handle materials such as salt, ammonium sulphate, potassium chloride, potassium sulphate or super lime biphosphate. Transporting these materials risks damage the metals' adhesion. After use, clean the machine fully with water.
- Avoid the tracks coming into contact with concrete walls.
- The tracks tend to slip on snow or icy roads. Check that you do not slip when moving or working on a slope in cold weather.
- Operating the machine in extremely cold weather may damage the rubber tracks and reduce their life span. Given the physical characteristics of rubber, observe the operating temperatures specified in this manual.
- Do not damage the tracks with the bucket when using the machine.
- Do not drive on the boundary between a flat surface and a slope to climb in reverse. Otherwise, reduce the speed.

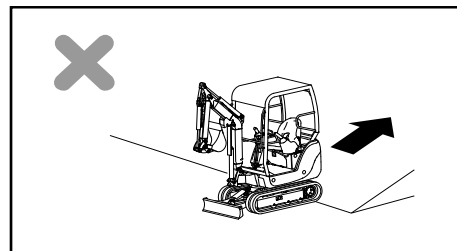

- Do not drive with a track on a slope or convex surface (one that generates an angle of over 10°) and the other track on flat ground; this will damage the tracks. Drive with both tracks on the same flat surface.

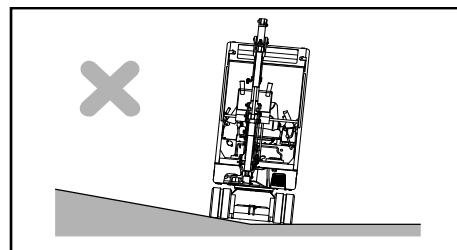

9 Rubber tracks

- Keep the tracks at their adequate tension to avoid them coming off. If the voltage is too low, the machine can throw a track in the following circumstances:

- When there is a significant difference in level, there is a spacing between the tracks and the rollers.

1 = Track

2 = Tightener roller

- When you carry out side movement in reverse, there is another spacing between the tension roller and the track.

3 = Idle wheel

- when the machine is moving although the tracks have been blocked to the side by an obstacle.

- when the idler pulley and the rollers are not aligned with respect to the tracks.

A = Chassis side

B = Rubber track side

- when you are reversing under these conditions.

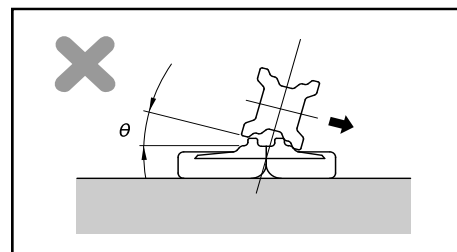
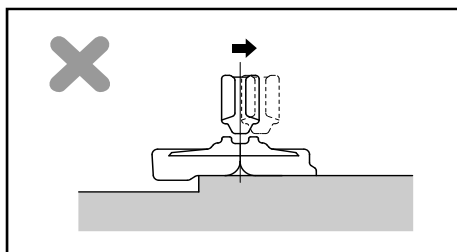
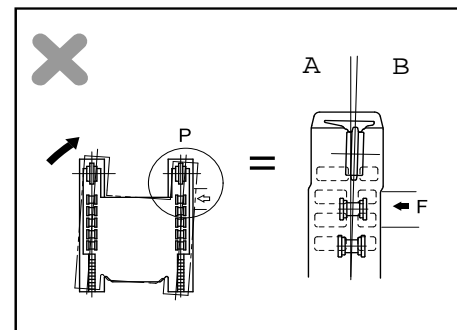
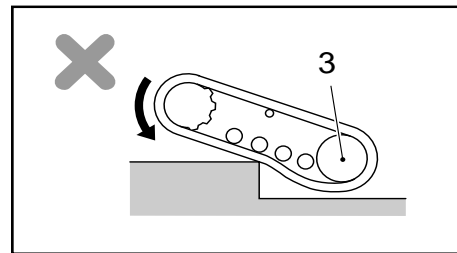
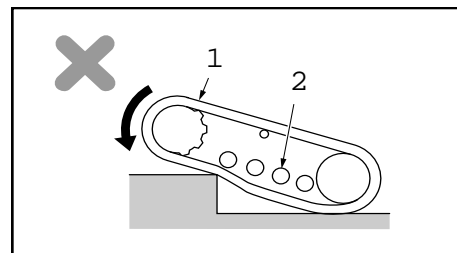
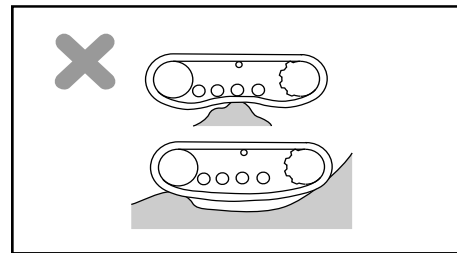

9.5 Track maintenance

6.4 Rubber track maintenance, page 147



9 Rubber tracks

9.6 Track replacement

 6.4.2 Track replacement, page 149

10 HANDLING THE BUCKET

10.1 Machine stability when using with a bucket or an accessory

- The maximum weight when in use in bucket mode or with accessories ensure machine dynamic stability in use. It corresponds to the maximum weight allowed at the end of the empty arm.
- This weight is determined for the machine on a flat and firm ground under the most unfavourable conditions and is indicated in the table below.

1 Lifting SV26 Cabin, page 171

	1150 mm	1400 mm	
	370	330	
	405	380	

2 Lifting SV26 Canopy, page 172

	1150 mm	1400 mm	
	330	300	
	380	345	

- It must absolutely be taken into account by the operator before using the machine for excavation, levelling operations or in working conditions with the accessories.
- Depending on the machine configuration (arm length, presence of a counterweight...) and working conditions, the operator must make sure that :
 - The equipment and accessories selection is made according to the nature of the task to be carried out and according to the machine's stability limits.
 - the total weight of the quick coupler, the accessories used (bucket, hydraulic hammer...) and the load handled does not exceed the maximum weight allowed.

DANGER

Any excess can lead to a loss of stability of the machine and tip it over. YANMAR CONSTRUCTION EQUIPMENT EUROPE S.A.S. accepts no responsibility in case of non compliance with the safety instructions described in this chapter.

10 Handling the bucket

WARNING

When using the machine with a heavy accessory (bucket in loader mode or log loader for example) associated with travel movement, the maximum weight guaranteeing the stability of the machine and the loads shown in the lifting table must be reduced by 20%.

	L++ 	
Max 	xxxkg xxxkg	
-	-	

To determine the weight that your machine will handle, make the following calculation:

Weight handled =
+ Weight of equipped quick coupler
+ Weight of the accessory (hammer, empty bucket...)
+ Bucket load capacity x material density)

This operation is reminded by a sticker affixed in the cab interior and visible from the driver's compartment. Compare the result with the maximum weight under condition of use with bucket, shovel or with accessories.

Weight of quick coupler and accessories (hammer, empty bucket...):

Please refer to the stickers or C.E. and manufacturer's plates affixed on the accessories mounted on your machine.

C.E. sticker sample

Logo société	ADRESSE
REFERENCE:	
N° DE SERIE:	
VOLUME/CHARGE: SAE	L Kg
LARGEUR:	mm
POIDS:	Kg
PRESSION NOMINALE MAXI:	bar
ANNEE DE FABRICATION:	

Manufacturer's plate example

MODELE		
Référence:	XXXXXX	LOGO Fabricant
N° de série:	XXXX	
Volume:	00 litres	
Poids:	00 kg	ADRESSE DU FABRICANT

10 Handling the bucket

Weight of material handled:

The bucket loading capacity (or SAE volume) allows calculating the weight of material handled in the bucket (in case of full buckets) and it takes into account the extra weight caused by the dome piling of certain materials. To determine the weight of materials handled, make the following calculation:

$$\text{Weight of materials (kg)} = \text{Load Capacity (L)} \times \text{Density}$$

Materials	Density
Sand	1,64
Clay	1,7
Mud	1,8
Gravel	1,5

The density of the materials has a great influence on the weight of the load handled. The opposite table specifies the density of the most commonly handled materials.

10.2 Compatible accessories

- These accessories are given for 1.8 density materials with a full bucket forming a dome in accordance with ISO standard 7451. For particular operations or with materials of different densities (partial bucket filling due to fluid products such as mud) larger buckets may be used.
- In this case it is the responsibility of the user to ensure that the machine stability limit is not exceeded. The machine could tip over, which could cause serious physical injuries and extensive material damage.

10.1 Machine stability when using with a bucket or an accessory, page 99

- Do not use accessories that are not listed in this chapter. The user must ensure that the accessory is compatible with the capabilities of the machine and the task at hand. If in doubt, contact the accessory manufacturer or dealer.

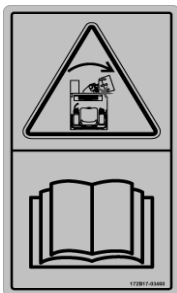

WARNING

When using a large accessory, keep the accessory at a sufficient distance from the cab to avoid hitting the cabin with the accessory during the rotation of the boom.



10 Handling the bucket

Mounting without quick coupler

Bucket	Retro bucket	G3-700
	Ditching bucket	G3C-1400
	Swivel ditching bucket	G3P-1000
	Loading bucket	G3-500
G3C-1000		
Hydraulic hammer		DMS 165

Mounting with quick coupler

Mechanical cam (ACB Morin)	Quick attachment	Module	GMO 0701M1
	Bucket	Retro bucket	R13-700
		Ditching bucket	CM1-1400
		Swivel ditching bucket	CIM1-1200
		Loading bucket	R13-550
			CM1-1000
Hydraulic hammer	DMS 165		
Mechanical wedge (Arden equipment)	Quick attachment		QA 05A
	Bucket	Retro bucket	R05G31-060
		Ditching bucket	C05R08-120
		Swivel ditching bucket	C05I04-120
		Loading bucket	-
	-		
	Quick attachment		QA 11M
	Bucket	Retro bucket	R10G11-070
		Ditching bucket	C10R08-120
		Swivel ditching bucket	C11I04-120
Loading bucket		-	
	-		
Hydraulic hammer		DMS 165	
Mechanical wedge (CSERI)	Quick attachment		SW03
	Bucket	Retro bucket	C-TL2,5-700
		Ditching bucket	C GL2,5-1200
		Swivel ditching bucket	C GLV2,5-1200
		Loading bucket	C TL2,5-600
	C GL2,5-1200		
Hydraulic hammer		DMS 165	

10 Handling the bucket

(CSERI)Hydraulic corner	Quick attachment		HSW03
	Bucket	Retro bucket	C TL2,5-700
		Ditching bucket	C GL2,5-1200
		Swivel ditching bucket	C GLV2,5-1200
		Loading bucket	C TL2,5-600
	C GL2,5-1200		
Hydraulic hammer		DMS 165	

10.3 Operation of the retro bucket

- The retro bucket is adapted to dig the ground at a level below the machine.
- The maximum digging force is obtained when the angle between the bucket cylinder and the bucket arm and the angle between the arm cylinder and the arm is 90°.
- For maximum effectiveness, handle the arm within the range illustrated opposite : 45° forward and 30° back.
- Do not move the equipment to the end of the cylinder run.

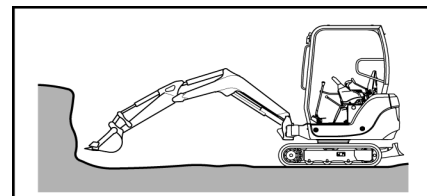
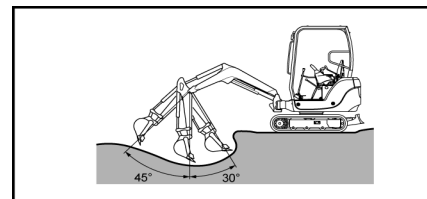
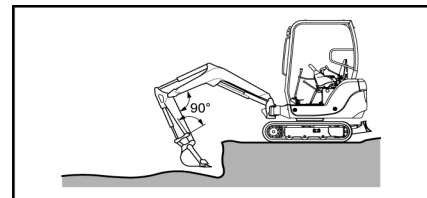

- To dig at a level above the machine, install the bucket in the reverse position.

12.2.1 Loading bucket, page 109

10.1 Machine stability when using with a bucket or an accessory, page 99

10.4 Digging trenches

- To increase the effectiveness of the machine, place an appropriate bucket to dig a trench and position the tracks in parallel on each side of the trench to be dug.
- To dig a wide trench, dig on the two sides then the centre.

1 = Parallel

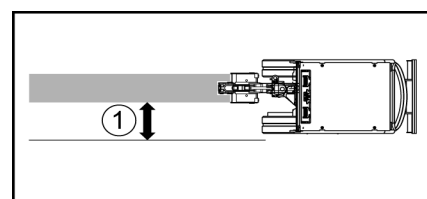

10 Handling the bucket

10.5 Loading

- To increase effectiveness, position the skip truck at a location where the operator may view it and where the machine's rotation angle is minimised.
- Load the earth from the back of the truck to facilitate loading and maximise the quantity of earth loaded.

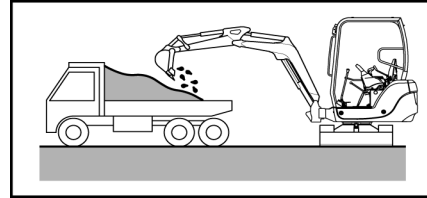

11 HANDLING OF ACCESSORIES

11.1 Hydraulic hammer SOCOMEC

Usage recommendations

⚠ WARNING

During the work phase, keep everyone out of the 20m danger zone.

IMPORTANT

- The hammer must be at 90° to the working surface.
- In a submerged area, make sure that the water does not reach the body of the hammer.

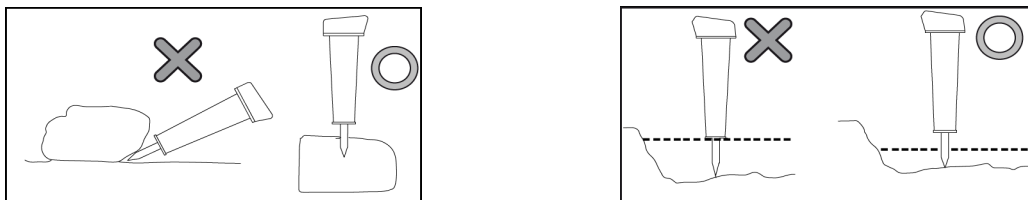

Note

The hammer can only operate within the following temperature range:
[-5°C ~ +45°C]

- To avoid damaging the structure of the hammer and minimize vibration, the operator must be smooth when using the tool. Be sure to set the engine speed if you are using a hammer.
- Once the work requiring the hammer is finished, set the hammer vertically with respect to the ground and leave it in this position to facilitate drainage of condensation on the side of the piston.

Tool change

IMPORTANT

- Do the following operations with gloves and safety shoes.
 - Always use oils and greases recommended by YANMAR.
1. Park the machine preferably on a stable, flat and level surface.
 2. Place the accessory at about 30 cm above the ground in horizontal position.
 3. Stop the engine.
 4. To remove the tool from the housing:

11 Handling of accessories

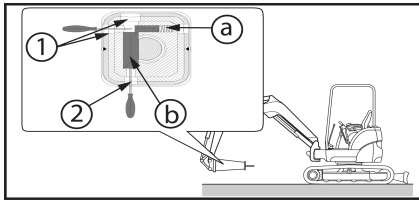

a. Use a lever to press the pin (A) and to push it into its housing (1) (2 cases possible depending on model).

b. Use a second lever to press the stop swivel pin (B) and push it out completely (2).

c. Remove the tool from the seat.

5. Apply plenty of grease to the part in the new tool guide.
6. Manually fit the flat end of the tool into the guide.
7. Push and turn the tool in order to position it parallel to the pin housing
8. Use a lever to press the pin stop and make it fit into place
9. Insert the pin until the pin stop returns to its position.

Note

There are different forms of tools that can equip the hammer. Contact your dealer.

- If the hammer is inactive for a long period, you must:
 - Pull out the tool and, after pushing the piston as high as possible (using a tube) grease it thoroughly and reassemble the tool. This prevents oxidation of the piston end.
 - Shelter the hammer in a confined area that is protected from the weather.

12 ACCESSORY CHANGE BY DIRECT COUPLING

12.1 Dismantling the accessory

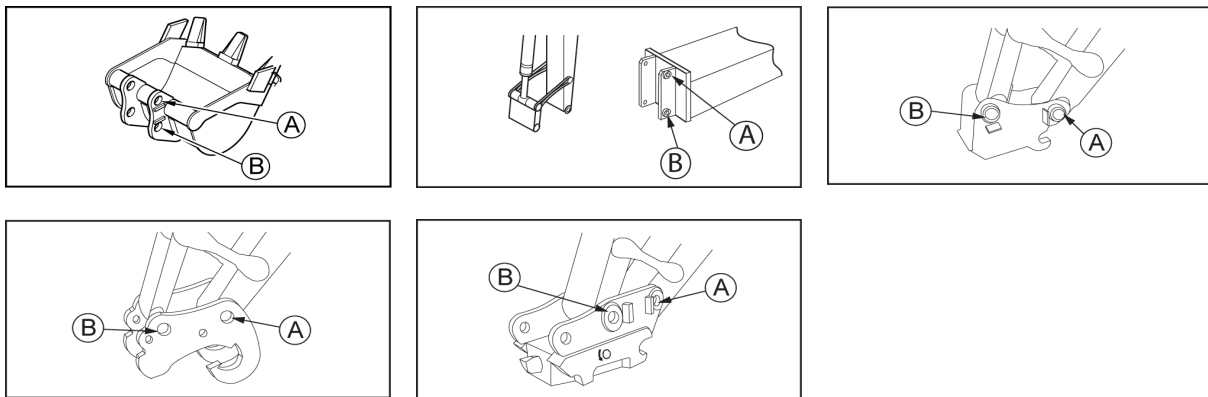

A & B = Bucket or attachment bore

1. Place the machine on flat ground.
2. Place the accessory at about 5 cm above the ground.
3. Stop the engine.
4. Clean all the parts.
5. Remove the swivel pin from the A bore and the swivel pin from the B bore.

IMPORTANT

- **Protect the various elements from dirt and dust.**
- **Take care not to damage seals on each bushing side.**
- **Verify the good state of o-rings. Replace them if they are damaged.**

12 Accessory change by direct coupling

12.2 Mounting the accessory

IMPORTANT

Before using an accessory requiring hydraulic power, check the pressure compatibility from the machine specifications chart.

 1 Specifications, page 165

WARNING

Before mounting a bucket or an accessory on your machine, make sure that:

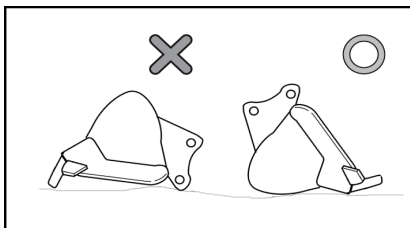

- the bucket or accessory is compatible with the capabilities of your machine;

 10.2 Compatible accessories, page 101

- the bucket or accessory mounting operation is performed on a level and stable ground;
- the bucket or accessory is properly positioned to be installed on the machine.

1. Clean and lubricate the bores.
2. Put the o-rings in place.
3. Align the arm bore with the bore A.
Add shims to compensate for play if necessary.

4. Insert the swivel pin into the bore A
5. Align the pin bore with the bore B.
Add shims to compensate for play if necessary.

6. Insert the swivel pin into the bore B
7. Install the stop systems depending on the accessory model mounted on the machine.

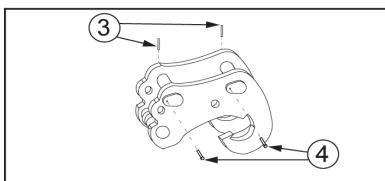
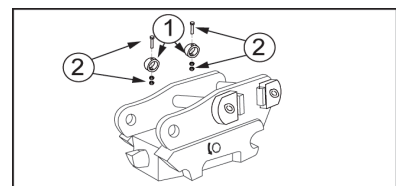
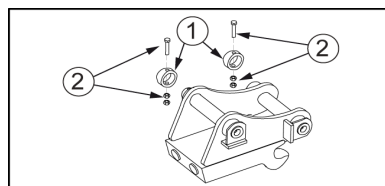
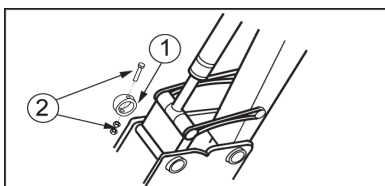

- 1= Rings
2= Bolts
3= Pins
4= Set screw

12 Accessory change by direct coupling

Note

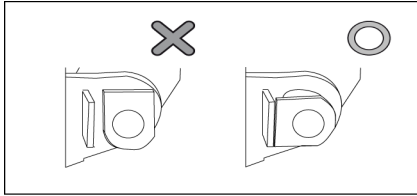

Make sure to install the swivel pin stops correctly by positioning them with the flat plane against the stop.

8. Grease the hinged parts.

Special features concerning the hammers

1. Connect the coupled hoses from the hammer to the machine connections.

14 Implementing the 3rd hydraulic circuit, page 112

2. In the absence of quick couplers, remove the plugs from the hoses on the machine and drain the oil accumulated in the hoses.

Always drain the machine's oil into a safe container and never directly onto the ground.

3. Connect ports A and P, then ports B and T with hydraulic hoses.

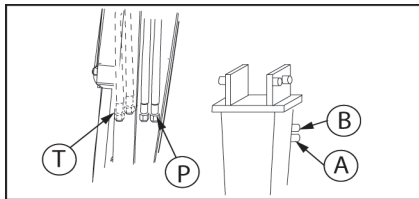

12.2.1 Loading bucket

IMPORTANT

Protect the various elements from dirt and dust.

Take care not to damage seals on each bushing side.

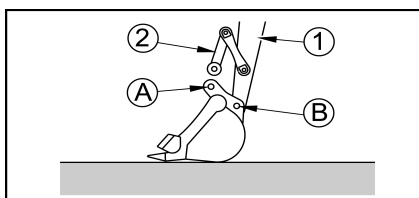

1 = Arm
2 = Bucket link

1. Clean and lubricate the bores.
2. Put the o-rings in place.
3. Align the pin bore with the bucket A bore.
Add shims to compensate for play if necessary.
4. Insert the swivel pin into bore A.



12 Accessory change by direct coupling

5. Lift the equipment and align the arm bore with the bucket B bore holding the bucket about 5 cm of the ground.

Add shims to compensate for play if necessary.

6. Insert the swivel pin into bore B.

7. Put the bolts in place on axes A and B.

8. Grease the hinged parts.



13 LOAD LIFTING

Do not hang a load without the kit's lifting facilities.

 7.6 Lifting Kit, page 40

WARNING

It is forbidden to lift loads over people.

IMPORTANT

It is forbidden to handle the loads without turning on the overload box.

To make lifting a load with the machine, use the following procedure:

1. Check that the WLL² of the lifting accessories used are compatible with the load being lifted.
2. See the load tables for your machine so you do not exceed these limits during the lifting operation.
3. Install a device that can oppose the accidental release of the load on the machine's lifting ring (with latch hook, shackle, eye...) and whose WLL² is equal to or greater than the load to be lifted.
4. Attach the load to be handled with the lifting accessory.
5. Pass the lifting accessory in the lifting device and lock the device.
6. Turn the overload housing switch to ON located in the machine's cab.
7. Lift the load slowly and smoothly.

Note

Never lift a load roughly; the quick movements and sudden stops can cause overloads.

IMPORTANT

Limit the load's lifting height as much as possible during handling.

2. Working load limit(WLL)

14 IMPLEMENTING THE 3RD HYDRAULIC CIRCUIT

14.1 Description

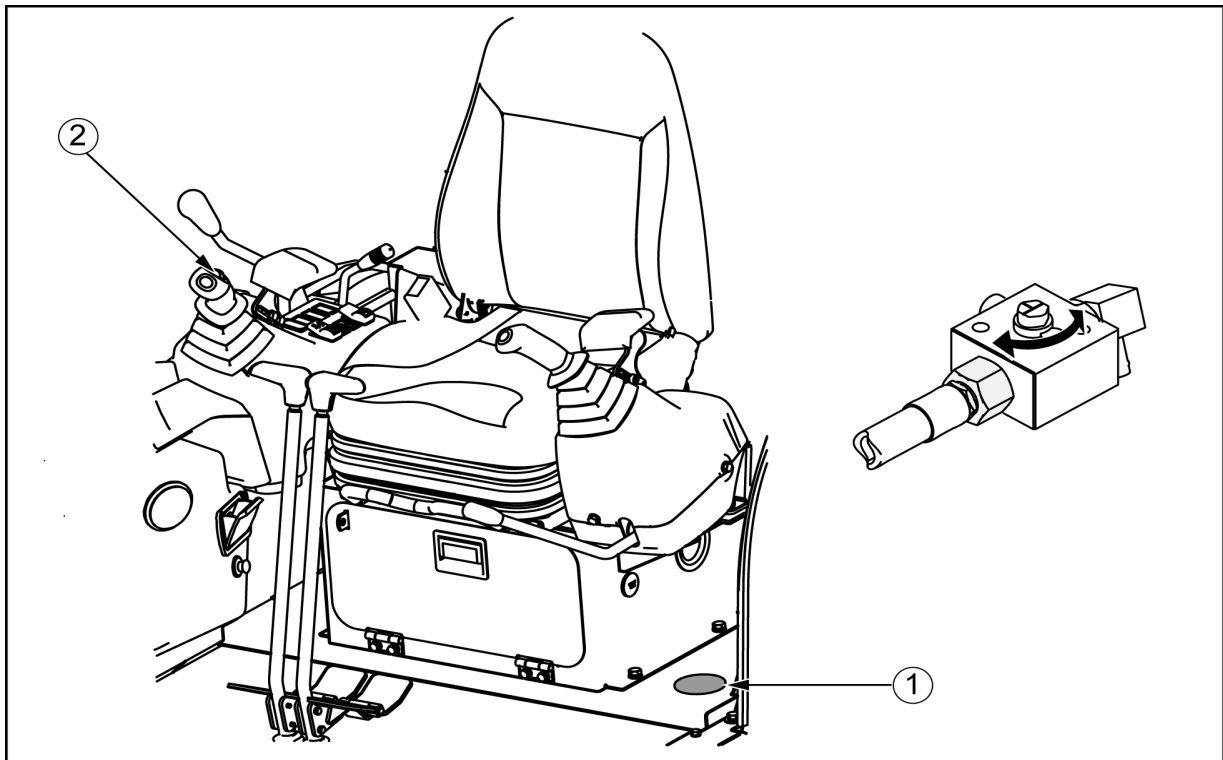

1= 3rd circuit selector

2= 3rd hydraulic circuit control

CAUTION

Do not operate the controls of the 3rd circuit if there are no installed accessories.

14.1.1 3rd circuit selector

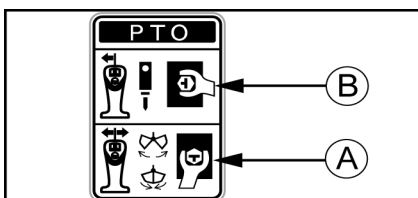

- Remove the rubber cap to use the 3rd circuit valve and select the single or double action mode.

A = 3rd circuit - dual effect

B = 3rd circuit - single effect with direct tank return

14 Implementing the 3rd hydraulic circuit

14.2 Mounting the accessory

WARNING

Before performing any maintenance operation, remove residual pressure in the hydraulic circuit.

2.1.2 Removing the residual pressure, page 131

Always drain the machine's oil into a safe container and never directly onto the ground.

1. Stop the engine.
2. Remove the caps.
3. Connect the hydraulic tool's hoses.

Hydraulic oil rate at nominal engine speed :

1 Specifications, page 165.

14.3 Precautions for using the accessory

- Follow the procedures described in the user manual provided by the accessory's manufacturer.

Hydraulic hammer (single action accessory)

- Set the return pipe selector valve to the position for a single action accessory.
- The hammer works when the proportional roller is operated.

Tilting bucket

- Position the return circuit selector valve to the position for a dual action accessory.
- Use the proportional roller to operate the accessory.

15 TRANSPORTING THE MACHINE

WARNING

Choose a road taking account of the width, height and weight of the machine loaded on the truck.

Transport the machine safely according to the rules associated with applicable legislation.

15.1 Loading/unloading the machine

15.1.1 Precautions for loading/unloading the machine

- Load or unload the machine on a flat, firm surface, a good distance away from any verges.
- Use adequate power ramps with hooks at their extremities.
- Make sure the ramps are sufficiently wide, long and thick to hold the machine so that you can load it and unload it safely. If the ramps flex excessively, consolidate them with wedges.
- Install the ramp safely on the truck deck so that they do not become detached.
- Clean grease, oil and any other slippery deposits from the ramps and remove the mud from the tracks to avoid the machine sliding sideways on the plates.
- Do not load or unload the machine if the ramps are slippery due to rain, snow or frost.
- Load or unload the machine at reduced speed.
- Never change the direction of travel on the ramps. If you need to change your path, take the ramps down, and do it on the ground.

15.1.2 Procedure

1. Engage the truck's brake.
2. Position buttresses to immobilise the truck.
3. Position the ramp plates on the truck deck so that the centre of the truck and the centre of the machine are aligned. Check that the left and right ramp plates are at the same level.
4. The angle between the ground and the ramp plates must be less than 15°.

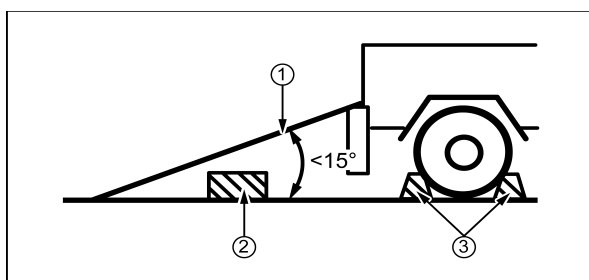

- 1 = Ramps
- 2 = Wedge
- 3 = Stops

Note

Determine the spacing between the ramp plates based on the centre of the track runners.

15 Transporting the machine

5. Place the accelerator pedal to idle position.
6. Direct the machine towards the ramp plates at low speed and load the machine onto the truck. Do not use levers other than the side movement levers when travelling across the ramp plates.

15.2 Immobilising the machine on the truck

Once the machine is in a suitable position on the truck, immobilise it as follows :

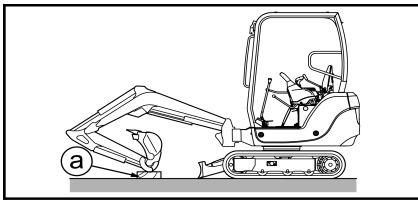

1. Lower the blade to the ground.
2. Fold the bucket and the arm to the maximum, then lower the boom to wedge the arm on a wooden block. (a)
3. Turn the key to OFF position to switch off the engine and disconnect the electrical circuit. Remove the key from the ignition.

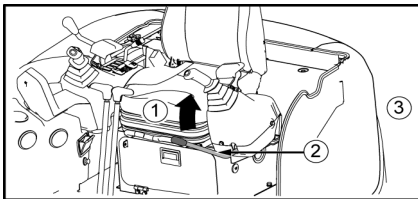

4. Lock the control levers with the locking lever.
- 1 = Locking
2 = Locking lever
3 = Left hand side

Note

The hydraulic brake locks the rotation motor.

15.3 Tying down the machine

⚠ WARNING

Do not perform the tie-down if a person stands on the machine or on an accessory.

⚠ WARNING

Use a tie-down accessory (belt, chain, cable) compatible with the weight of the machine and compliant with European standards.

Check the tie-down accessory labelling to know the WLL³. In the absence of or damage to the accessory labelling, do not use it without being assured of its WLL³.

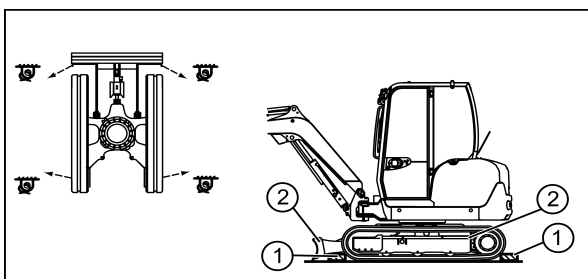

- 1 = Wedge
2 = Anchor points

3. Working Load Limit (WLL)

15 Transporting the machine

1. Check the condition of the transport vehicle surface. If the surface is greasy, it must be cleaned before installing the machine on the transport vehicle.

Note

If the transport vehicle surface is steel, provide a non-slip mat or spacers to prevent the machine tracks from slipping.

2. Check the WLL⁴ of the tie-down points of the transport vehicle, it must be at least the WLL⁴ recommended for tying down the accessories.

 **D Lashing record, page 184**

3. Check the location and condition of the machine tie-down points.

4. Tie-down the machine at the points provided for that purpose and that are indicated on the machine. YANMAR CONSTRUCTION EQUIPMENT EUROPE recommends securing the machine according to the diagonal direct tie-down method respecting the angles shown below.

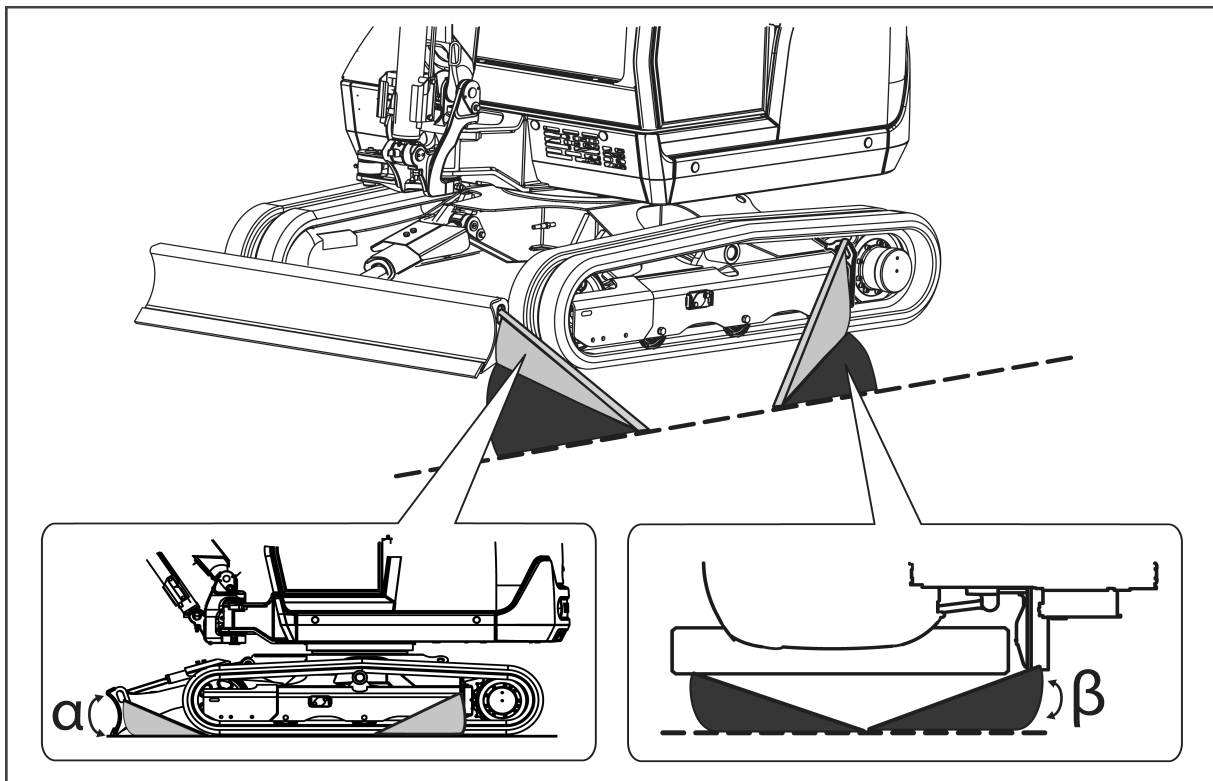

Angle	Value in degrees
α	20°-60°
β	10°-60°

 **3 Warning labels, page 6**

IMPORTANT

If other tie-down methods are used, YANMAR CONSTRUCTION EQUIPMENT EUROPE does not guarantee the machine tie-down.

The driver must ensure that the angles α and β are determined so that there is no deflection of the tie-down accessories.

4. Working Load Limit (WLL)

15 Transporting the machine

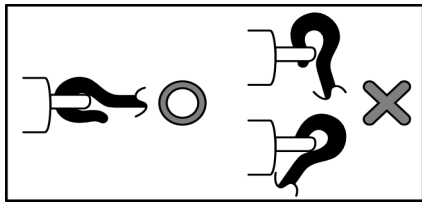

- a. Correctly position the hooks on the tie-down points.
- b. Be alert to where tie-down accessories pass; they should not rest on sharp edges or have knots present when tying down.
- c. Make sure to load balance the various tie-downs and do not overload them.

WARNING

Before starting the machine transportation, check the total height of the load.

15.4 Slinging the machine

WARNING

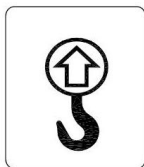

Never lift the machine with someone on it or on an accessory.
Use a slinging method that is compatible with the weight of the machine and that complies with current standards.

If you do not lift the machine as shown, it will be out of balance.

Do not pivot the machine when it has been raised.

Never walk under or beside a suspended machine.

1. Pivot the upper structure so that the blade is behind the operator's seat.
2. Lift the blade to the maximum limit.
3. Place the equipment in the longitudinal axis of the machine.
4. Place all the equipment cylinders to maximum extension (except the rotation cylinder).
5. Stop the engine, put the levers in the locked position and check that you have left nothing around the operator's seat before leaving the machine.

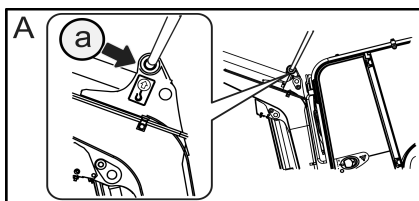

A = Front side

B = Back side

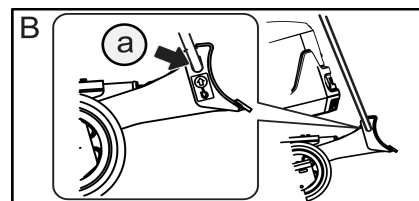

a = Lifting holes at each end

3 Warning labels, page 6

15 Transporting the machine

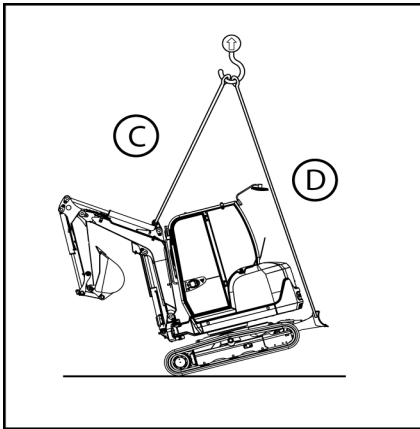

- Lift the machine as follows:
 1. Hook the shackles to the suspension holes at the front (1 point) and the rear (2 points).
 2. Load lifting accessories carefully.
 3. Gently suspend the machine and wait until it stabilises before continuing to lift it.

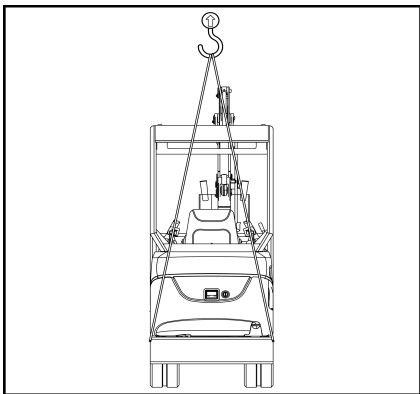

	Length (m)	W.L.L. ⁵ (t)
C	1,5 m	2
D	3 m x 2	2

Note

Use only shackles having a WLL⁵ equal or greater than 2 t

5. Working Load Limit (WLL)

16 DETECTING ANOMALIES

16.1 phenomena that do not constitute faults

The following phenomena are not faults :

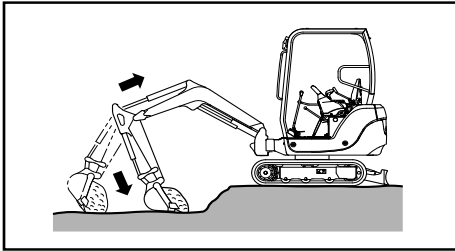

- **Bucket shaking**

When the boom is raised immediately after the arm is extended while the bucket is pulled back, the bucket may shake. This is not a fault.

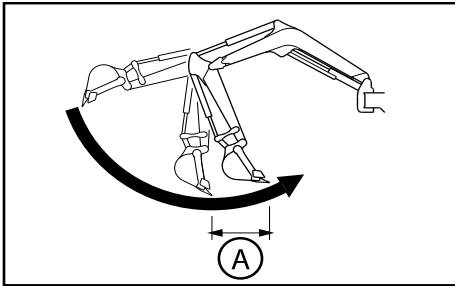

- **Discontinuous movement of the arm**

When you dig the ground with the arm, the arm may slow down temporarily in an almost vertical position. This is not a fault and occurs especially when the motor speed is low.

A = Slowdown is noticeable on this range.

- **Shift in the position of the upper chassis**

When you turn the machine suddenly, as in turning or pivoting, the upper chassis may be slightly offset.

- **Thermal shock for the side movement motor**

If, during cold weather, the hydraulic oil temperature rises to over 60°C in relation to the exterior temperature, during an unloading operation without movement after the engine starts the machine may not pivot because of a thermal shock. This is not a fault.

- **The rotation cylinder extends during excavation**

The rotation cylinder may extend in certain situations or excavation positions. This is not a fault.

- **Delayed reaction to the response to change of speed**

At slow engine rate, a reaction delay may occur when you reduce the speed. This phenomenon is not a breakdown.

16.2 Detecting anomalies

- Contact your dealer when the solution to the problem is indicated in brackets in the tables below.

- If an anomaly or a problem occurs and its cause is not one of those indicated below, ask your dealer to carry out a repair.



16 Detecting anomalies

16.2.1 Engine

Problem	Cause	Solution
Vapour comes out of the radiator.	Lack of cooling water.	Check the cooling water level. If necessary, top up the water. (Check any water leaks on and around the filling hole).
	Ventilator belt slack.	Adjust the belt tension.
	Build up of dust and tartar in the cooling circuit.	Drain the cooling circuit, clean it completely and fill it again.
The water temperature alarm light comes on.	Defective thermostat.	Replace the thermostat.
	Radiator blade blocked or twisted.	Clean or repair the blade.
	Defective electric circuit.	Check or replace the electric circuit.
The starter works correctly but the engine does not start.	Lack of fuel.	Top up the fuel tank.
	Air in the fuel circuit.	Repair the air leak. (Evacuate the air from the fuel circuit).
	Defective fuel injection pump or injector performance altered.	(Replace the pump or the injector).
	Inadequate compression.	(Check and repair).
	Blown fuse.	Replace the fuse.
	Stop solenoid damaged. Broken filament.	(Check and repair).
Black smoke escapes from the machine.	Air filter element blocked.	Clean or repair the element.
	Altered injector performances.	(Check and repair).
	Inadequate compression.	(Check and repair).
The smoke is white or blue-white.	Too much oil in the oil casing.	Drain the oil from the casing to the specified level.
	Inadequate fuel.	Replace the fuel with a recommended fuel.
	Piston or segment used.	(Repair).



16 Detecting anomalies

16.2.2 Electrical equipment

Problem	Cause	Solution
Positioning the starter switch to START does not launch the starter motor.	Defective electric circuit.	Check and replace the electric circuit.
	Defective starter switch.	Replace the starter switch.
	Battery insufficiently charged.	Recharge the battery.
	Defective starter motor.	(Check and repair).
The maximum engine speed does not provide enough power to the lights.	Defective electric circuit.	Check the play and the proper connection of the terminals. Repair if necessary.
	Defective alternator or regulator.	(Check and repair).
When the engine is running, the lamp is very bright and burns out frequently.	Defective regulator.	(Replace the regulator).
Battery leak.	Defective battery.	Replace the battery.
The starter speed is too low.	Defective electric circuit.	Check and replace the electric circuit.
	Battery insufficiently charged.	Recharge the battery.
	Defective starter motor.	(Check and repair).



16 Detecting anomalies

16.2.3 Machine structure

Problem	Cause	Solution
The power or speed of the moving parts is low.	Lack of pressure due to wear on the hydraulic pump.	(Replace the hydraulic pump).
	Pressure drop in the distributor below the set value.	(Check and repair the valves).
	Damaged hydraulic cylinder.	(Check and repair).
	Insufficient quantity of hydraulic oil.	Fill the hydraulic oil to the required level.
	Clogged filter.	Clean or replace the filter.
The upper part does not rotate or does not rotate smoothly.	The rotation brake is not unlocked.	Unlock the rotation locking lever.
	Insufficient quantity of grease.	Check and lubricate.
	Defective rotation brake valve.	(Check and repair).
	Defective rotation motor.	(Check and repair).
The hydraulic oil temperature is too high.	Insufficient quantity of hydraulic oil.	Fill the hydraulic oil to the required level.
	Overload	Reduce the load.
The machine does not move forward in a straight line.	Track incorrectly tightened or foreign body jammed.	Adjust or clean.
	Damaged hydraulic motor.	(Check and repair).
	Defective hydraulic pump.	(Check and repair).
	Defective safety valve.	(Check and repair).
	Sprocket, tightening roller or tracker roller damaged.	(Check and repair).

17 IF THE BATTERY IS DISCHARGED

17.1 Precautions for connecting and disconnecting the starter cables

WARNING

- When you start the engine using connection cables, wear protective goggles.
- If you start the engine by taking electrical power from another machine, check that your machine does not come into contact with the other machine.
- To connect the starter cables, start with the positive terminal. To disconnect them, start with the negative terminal (mass).
- If a tool comes into contact with the machine's positive terminal, there is a risk of sparks.
- Do not connect the connection cables to the terminals in reverse polarity. For example, never connect the negative terminal on one machine to the positive terminal on the other machine.

• To connect, start with the positive terminal (1).

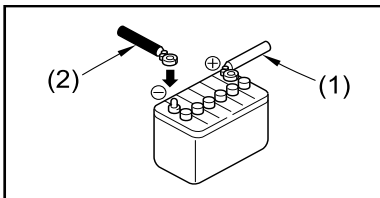

• To disconnect, start with the negative terminal (1).

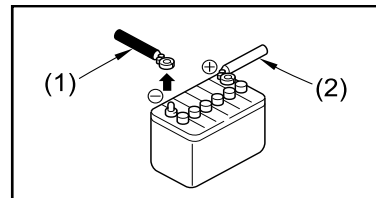

- The capacity of the starter cables and the size of the clips must be adapted to the size of the battery.
- Check that there is no damage, cracks or corrosion on the starter cables and clips.
- The machines' batteries must have the same capacity.

17 If the battery is discharged

17.2 Connecting the starter cables

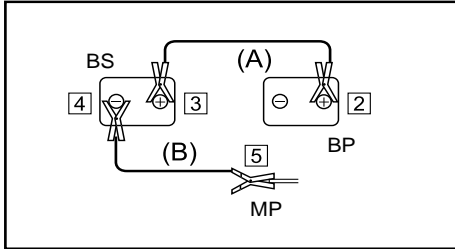

BS = backup battery

BP = battery broken down

MP = machine engine broken down

1. Set the start switches on both machines to OFF.
2. Connect the clip of the red starter cable (A) to the positive terminal of the battery on the machine that has broken down.
3. Connect the other clip of the red starter cable (A) to the positive terminal of the battery on the repair machine.
4. Connect the clip of the black starter cable (B) to the negative terminal of the battery on the repairing machine.
5. Connect the other clip of the black starter cable (B) to the engine block of the machine that has broken down.

17.3 Starting the engine

1. Check that the cables are connected safely to the battery terminals.
2. Start the engine on the repair machine and increase the engine speed to maximum.
3. Turn the starter switch of the machine that has broken down to START to start the engine. If the engine does not start, wait at least two minutes before trying again. Do not stop the engine on the repair machine and keep the engine speed at full rate.

17.4 Disconnecting the starter cables

- After starting the engine on the machine that has broken down, disconnect the starter cables in reverse order to the connection procedure.

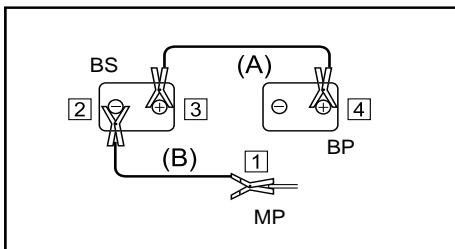

BS = backup battery

BP = battery broken down

MP = machine engine broken down

1. Remove the clip of the black starter cable (B) from the engine block of the machine that has broken down.
2. Remove the clip of the black starter cable (B) from the negative terminal of the battery on the repairing machine.
3. Remove the clip of the red starter cable (A) from the positive terminal of the battery on the repairing machine.
4. Remove the clip of the red starter cable (A) from the positive terminal of the battery on machine that has broken down.



17 If the battery is discharged

17.5 Charging the battery

- Remove the cables from the positive and negative terminals of the battery before setting the battery to charge. Otherwise, abnormal voltage may be applied to the alternator and may damage it.
- When the battery is charging, remove all the plugs to release the gases generated.
- If the battery overheats (the electrolyte temperature exceeds 45°C), stop the operation.
- Stop the charging operation as soon as the battery is charged. If you continue, the following faults may occur :
 - battery overload
 - reduction in the battery electrolyte
 - battery failure
- Do not connect the connection cables to the terminals in reverse polarity. For example, never connect the negative terminal on one machine to the positive terminal on the other machine. A polarity reversal may damage the alternator.
- The battery must only be handled once the cables have been disconnected (except for checking the level of electrolyte and the specific electrolyte density measurement).

18 TOWING THE MACHINE

⚠ WARNING

Always tow a machine that has broken down in complete safety by using the suitable tools. An unsuitable procedure may cause serious physical injuries.

⚠ IMPORTANT

Check that the metal cables, the slings and the towing mechanisms to be used are resistant enough and that they are not cracked or broken. Never tow the machine that is only attached to a hook.

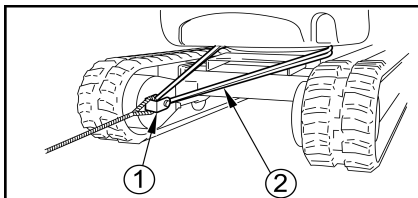

- When the machine gets stuck in the mud and cannot get out on its own, or when it is towing a heavy object, attach the sling as shown opposite.

1 = Shackles

2 = Slings

- Minimum capacities of the coupling devices to use:

	W.L.L. ⁷ (t)
Shackles	> 5
Slings	> 5

- When towing a machine with another machine, use a metal cable that is powerful enough for the machine's weight.
- Never tow the machine on a slope.
- Never use a deformed or damaged towing cable.
- Do not roll over the towing cable or the metal cable.
- When you hook on an object to be towed, make sure that there is no-one between the machine and the object.

7. Working Load Limit (WLL)



C Periodic maintenance programme

CHAPTERS COVERED IN THIS CHAPTER:

- 1 PERIODIC INSPECTIONS AND UPKEEPS
- 2 MAINTENANCE PRECAUTIONS
- 3 RECOMMENDED GREASES AND FLUIDS
- 4 FIRST MAINTENANCE
- 5 LIST OF PERIODIC INSPECTIONS AND MAINTENANCE OPERATIONS
- 6 MAINTENANCE BY THE OPERATOR
- 7 MAINTENANCE BY THE DEALER





1 PERIODIC INSPECTIONS AND UPKEEPS

○: Verification and adjustment

●: Replacement

□: Cleaning

■: Greasing

Parts & Operations		Daily	Every 50h	Every 250h	Every 500h	Every 1000h / Every year	Every 2000h / Every two years
General.	Missing or broken parts	○					
	Tightening of nuts and bolts	○					
	Motor state	○					
	Machine	□					
Transmissions	Oil for travel gears		● 1st time		○	●	
	Rotation reducer		● 1st time		○	●	
Hydraulic circuit	Hydraulic oil	○				●	
	Aspiration filter					□	
	Hydraulic oil return filter		● 1st time		●		
	Operation of the accumulator	○					
Greasing	Greasing points	■					
	Rotation pin and crown		■				
Chassis	Bearing rollers and bearings, idler wheels	○				■	
	Track tension	○					
Electrical equipment	Headlights, horn, travel alarm	○					
	Dashboard and indicators	○					
	System state	○					
Engine	Water separator	○					
	GO filter			●	●		
	Air filter (dusty atmosphere every 250 h)				●		
	Engine oil	○	● 1st time		●		
	Oil filter		● 1st time		●		
	Cooling fluid	○				●	
	Belt	○				●	
	Radiator vents	○				□	
	Fuel hose, coolant hose						●
	Intake and exhaust valves					○	
Injectors and injection pressure						○	
Heating					○		

1 Periodic inspections and upkeeps

Scheduled maintenance points of the machine (lubrication, filters...)

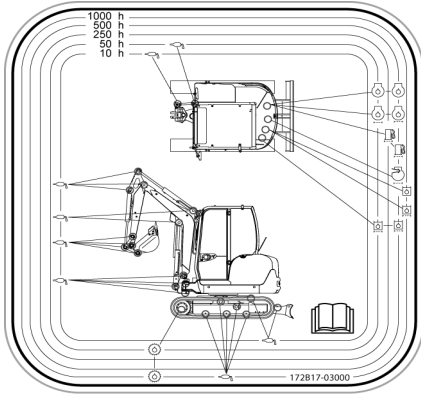

- = Hydraulic oil
- = Engine oil
- = Hydraulic oil return filter
- = Travel gears
- = Greasing points
- = Air filter
- = Fuel filter

2 MAINTENANCE PRECAUTIONS

2.1 Precautions before maintenance

2.1.1 Stop the engine.

- Park the machine on flat, firm ground.
- Stop the engine by turning the key from ON position to OFF position.

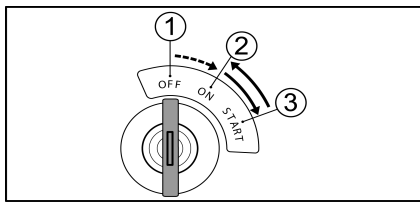

1= OFF
2= ON
3= START

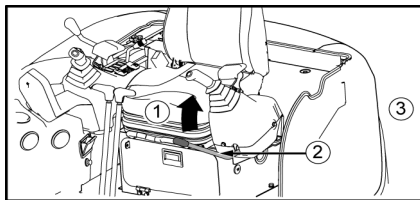

1 = Locking
2 = Locking lever
3= Left hand side

CAUTION

No maintenance operations described in this guide are to be performed with the engine running; please refer to the Maintenance Manual for any other operation.

2.1.2 Removing the residual pressure

Before performing any maintenance operation, remove residual pressure in the hydraulic circuit.

1. Perform the machine's parking operations.

2.4.2 Stopping the engine, page 76

2. Turn the key to the OFF position to stop the machine's engine, then turn it to the ON position.

Note

The locking lever must be lowered.

3. Handle the following controls several times to remove the residual pressure:

- Left command lever (Arm & Rotation of the upper part)
- Right command lever (Boom & Bucket)
- Blade lever
- 3rd hydraulic circuit control

4. Stop the engine by turning the key from ON position to OFF position.

5. Remove the key from the ignition.

The residual pressure in the accumulator is removed and there is no more pressure in the hydraulic circuit.

2 Maintenance precautions

2.1.3 Place a warning label

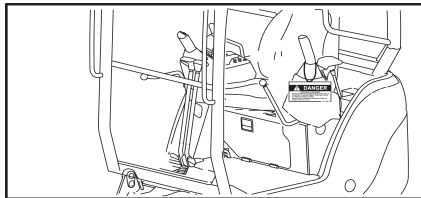

WARNING

Не манипулирайте лостовете за управление по време на поддръжката. Maintenance personnel may be seriously injured.

Place a MAINTENANCE IN PROGRESS label on the machine and on the joysticks.

2.1.4 Establish a safety perimeter

- Anyone who is not part of the maintenance team must be kept away from the working area.
- Pay attention to the safety of people nearby, notably during milling or welding operations or when a hammer is used.

2.1.5 Keep the machine clean

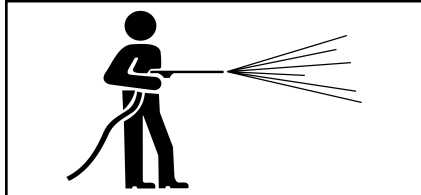

- Cleaning the machine will enable you to detect any leaks and defective parts quickly.
- Especially clean the filler cap, the vent hole and oil level glass gauge and prevent dust from mixing there.

- Spots of oil or grease or dispersed part fragments are dangerous and may cause slipping.
- Any water that gets into the electrical system may cause it to malfunction, leading to defective operation of the machine. This also risks causing short circuits that may cause a fire or electric shock.
- Do not spray any vapour directly onto the sensors or connectors.
- Do not use harsh chemicals to clean the machine, as these affect the visual and technical characteristics of the machine components. These products may also deteriorate the rigidity of the tank.
- Do not spill any water onto the dashboard.
- Do not spray water directly at high pressure onto the radiator or the oil radiator.
- Do not point the pressure washers on the electrical connectors.

2 Maintenance precautions

2.2 Precautions during maintenance

2.2.1 Oil and grease

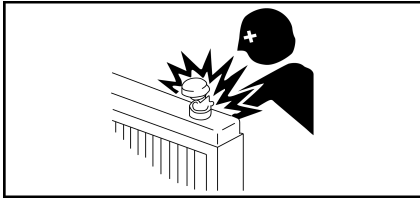

- Always use oils and greases recommended by YANMAR.

 **3 Recommended greases and fluids, page 137**

- Use clean oils and greases. Avoid any contamination by dust.

WARNING

Oil, grease or other fluids may be sprayed when certain parts are maintained.

For maintenance in complete safety, respect to the letter the procedures described in the following chapters.

IMPORTANT

Do not mix different types of oils. If you need to top up the oil with a different make or type from the oil left in the tank, remove the remaining oil completely.

2.2.2 Tools

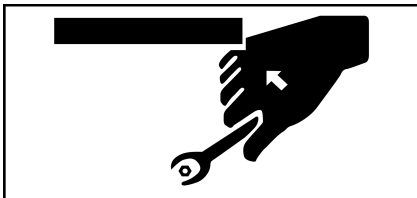

- Use tools that are adapted to the planned task.
- The use of damaged, worn or inappropriate tools is very dangerous and there is a risk that the machine will be damaged.

2.2.3 Parts

- Use YANMAR original parts as recommended in the parts catalogue.
- Clean parts with a non-combustible and non-aggressive detergent.
- If you need to remove a seal or a hydraulic component, refer to the maintenance manual.

2 Maintenance precautions

2.2.4 Dismantling the accessory



- If the scheduled task requires the dismantling of the accessory, remove it carefully by following the instructions described in this manual.

12.1 Dismantling the accessory, page 107

- Reinstall it carefully and follow the instructions described in this manual.

12.2 Mounting the accessory, page 108

2.2.5 Working under the machine

- Before you carry out any maintenance or repairs under the machine, place the accessory on the ground or in its lowest position.
- Perform the machine's parking operations.

2.4.2 Stopping the engine, page 76

- Before performing any maintenance operation, remove residual pressure in the hydraulic circuit.

2.1.2 Removing the residual pressure, page 131



DANGER

Park the machine on flat, firm ground.

If the machine is not stable, do not carry out any maintenance under the machine.

2.2.6 Lighting

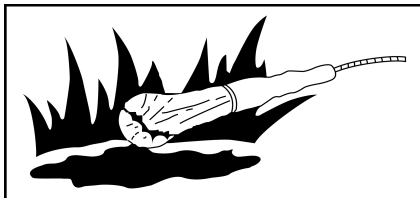

Use flameproof lighting when checking the fuel, oil, cooling water or battery electrolyte. If you do not, there is a risk of fire and explosion.

2 Maintenance precautions

2.2.7 Battery

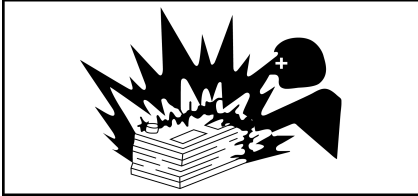

- Disconnect the negative terminal from the battery to disconnect the electric current when working on the electrical circuit (repair, welding).

2.2.8 Hoses

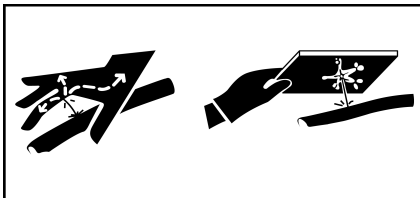

- Do not fold the high pressure hoses. Do not strike them against any hard objects.
- Damaged or incorrectly bent hoses, pipes and ducts explode easily under high pressure ; never reuse them.
- Fuel and oil leaks may cause a fire.

2.2.9 Radiator ventilator

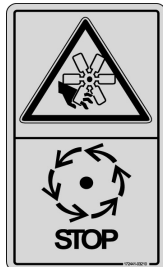

WARNING

Never touch the moving radiator ventilator or the ventilator belt with an object as this may cause serious physical injuries.

2.2.10 Soldering

If you need to solder, respect the following points :

- Disconnect the battery cabling (negative terminal then positive terminal).
- Disconnect the operator display station before performing a welding operation.
- Ground the machine no more than 1 metre away from the part to be welded.
- Make sure there are no seals or bearings between the soldered part and the earthed part.
- Do not earth near the axes of the equipment or the hydraulic cylinder.

2 Maintenance precautions

2.2.11 Waste processing

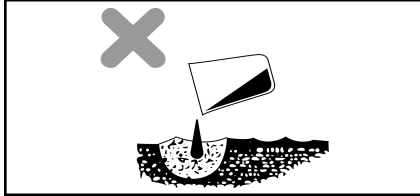

- Always drain the machine's oil into a safe container and never directly onto the ground.
- When you get rid of toxic waste such as fuel, oil, cooling water, solvents, filters and used batteries, respect the regulations that apply to this subject.



3 RECOMMENDED GREASES AND FLUIDS

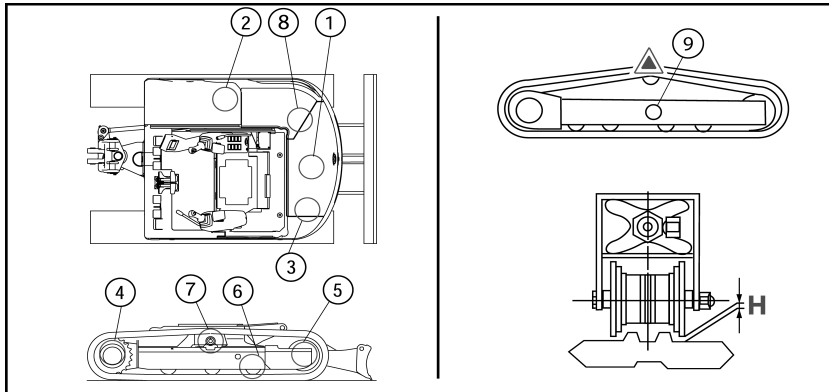

1= Engine oil

2= Fuel tank

3= Hydraulic oil

4= Sprocket wheel

5= Idle wheel

6= Track roller

7= Support roller

8= Cooling system

9= Greaser

- Select a fuel and an oil according to the machine's operating temperature.
- The machines may run on type B bio diesel.
- Always use a Yanmar long-life cooling fluid.

IMPORTANT

Do not mix different types of oils. If you need to top up the oil with a different make or type from the oil left in the tank, remove the remaining oil completely.

Components	Fluid	Temperatures °C							Quantity prescribed (L)	
		-	-20	-10	0	10	20	30		
Thermal engine	Engine oil	SAE 10W CD							3,7 + 0,4	Oil filter
		SAE 10W-30CD								
		SAE 15W-40CD								
Travel gears	Box oil	SAE 90 (GL-4)							0,5	by reducer
Hydraulic circuit	Hydraulic oil	ISO VG46							25,2	in the tank
									4,8	the rest
Fuel tank	Diesel	N° 2-D							38,5	-
		N° 3-D								
		N° 3-D (S)								
Cooling system	Long-life cooling fluid YANMAR POWER COOLANT B-36								3,8	radiator
									0,4	expansion flask



4 FIRST MAINTENANCE

4.1 After the first 50 hours of service

- Have the engine oil and the engine oil filter element replaced.
- Replace the side movement reducer oil.
- Greasing the pin and rotation crown
- Replace the hydraulic fluid return filter element.
- Contact your dealer.

4.2 After the first 250hours of service

- Fuel filter : Replacement
- Contact your dealer.

 1 Periodic inspections and upkeeps, page 129

5 LIST OF PERIODIC INSPECTIONS AND MAINTENANCE OPERATIONS

- The table below indicates the maintenance intervals to be respected for optimum operation of the machine. Read the machine's time counter every day to check whether a procedure should be implemented.
- The inspection sheets provided at the end of this manual enable you to keep a trace of the maintenance operations carried out.

IMPORTANT

These are frequencies : for examplen the operations to be carried out every 50 hours must be carried out at 50h, 100h, 150h, 200h, etc.

- Certain intervals may vary if a hydraulic hammer is used. Refer to the corresponding notes.

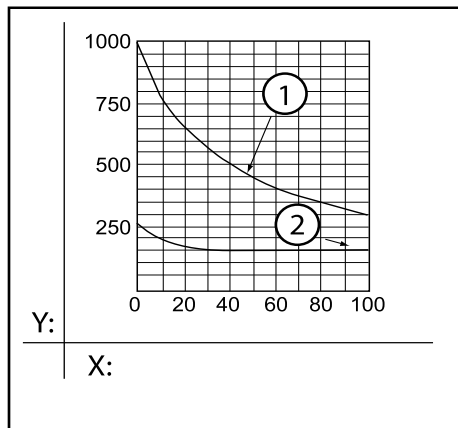

Note

- If a hydraulic hammer is used, the return filter must be replaced after 100 or 150 hours of service for a new machine, then according to the diagram opposite.
- The hydraulic oil must be replaced more frequently if a hydraulic hammer is used. Comply with the diagram opposite.

1 = Hydraulic oil















2 = Hydraulic oil return filter

X = Hydraulic hammer usage rate (%)

Y = Replacement interval (h)



5 List of periodic inspections and maintenance operations

Parts	Operations
Daily	
Machine	 6.1.1 Checking the machine before use, page 142
Commands	 6.1.3 Checking the commands, page 142
Seat	 6.1.4 Checking the seat, page 142
Greasing points	 6.1.5 Greasing points, page 143
Hydraulic oil	 4.5 Checking and topping up the hydraulic oil level, page 85
Hydraulic hoses	 6.1.9 Checking the hydraulic hoses, page 145
Fuel hoses	 6.1.10 Visual inspection of the fuel hoses, page 145
Fuel tank	 4.4 Checking and topping up the fuel level, page 83
Engine oil	 4.3 Checking and topping up the engine oil level, page 82
Cooling fluid	 4.2 Checking and topping up the level of cooling fluid, page 81
Tracks	 6.4 Rubber track maintenance, page 147
Radiator vents	Cleaning
Alternator belt	Tension check
Decanter/separator	 6.1.7 Cleaning the separator/decanter, page 144
Operation of the accumulator	Check
Electrical circuit	Check
Motor state	 16.2.1 Engine, page 120
Bearing rollers and bearings, idler wheels	Check
Every 50h	
Rotation pin and crown	 6.2.1 Greasing the pin and rotation crown, page 146
Every 250h	
Side movement and acceleration levers	Verification and adjustment
Fuel filter	Replacement



5 List of periodic inspections and maintenance operations

Parts	Operations
Every 500h	
Oil for travel gears	Replenish engine oil
Hydraulic oil return filter	Replacement
Fuel filter	Replacement
Air filter	Replacement
Engine oil	Replacement
Oil filter	Replacing the element
Radiator vents	Cleaning
Every 1000h	
Hydraulic oil	Replacement
Aspiration filter	Cleaning or replacement depending on the filter
Oil for travel gears	Replacement
Decanter/separator	Replacement
Alternator belt	Replacement
Cooling fluid	Replacement
Intake and exhaust valves	Play adjustment
Cylinder head block	Bolt re-tightening
Fuel pump	Check
Bearing rollers and bearings, idler wheels	Greasing
Heating	Verification and adjustment
Every 2000h	
Injectors and injection pressure	Inspection and calibration
Fuel hose, coolant hose	Verification and replacement
Intake and exhaust valves	Running in
Fuel pump	Adjustment check
Non periodic	
Fuses	6.3.1 Fuse replacement, page 146
Windscreen washer (for cab)	6.3.2 Top up the windscreen washer fluid.(for cab), page 147
Windscreen wiper (for cab)	6.3.3 Replacing the windscreen wiper (for cab), page 147
Tracks	6.4 Rubber track maintenance, page 147

6 MAINTENANCE BY THE OPERATOR

IMPORTANT

Before any upkeep or maintenance, follow the precautions described in this manual.

 2.1 Precautions before maintenance, page 131

6.1 Daily maintenance

6.1.1 Checking the machine before use

- Before each use of the machine, visually check the following :
 - no missing, broken or loose parts
 - ventilator belt correctly tightened
 - no oil, water or fuel leaks
 - engine and battery in good condition
- To detect leaks, wear protective goggles and thick gloves. Use a piece of card or plywood to detect leaks/sprays of hot oil. Consult a doctor immediately if you are hit with any oil.
- Also check that the time counter, the headlights, the alarm and the lights are working correctly.
- If an element is not working or you think it is defective, shut down the machine's engine immediately and contact your dealer.

6.1.2 Checks after using the machine

After each use, several checks must be carried out according to how the machine is used ; refer to chapter :

 6 Checks after use, page 89

6.1.3 Checking the commands

- Operate the commands.
- Release the levers, they should return to neutral position themselves.
- If they do not, contact your dealer.

6.1.4 Checking the seat

Check that the safety belt is present and in good condition.

6 Maintenance by the operator

6.1.5 Greasing points

- Grease the machine swivel pins daily using the nipples, and also before using the machine or after use in the rain, on soft ground or in muddy water.
- Proceed as follows :
 1. Lower the bucket and the blade to the ground.
 2. Stop the engine.
 3. Clean the greasing connectors indicated by the arrows on the figures.
 4. Grease them with a grease pump.
 5. Wipe off the excess grease with a cloth or equivalent.

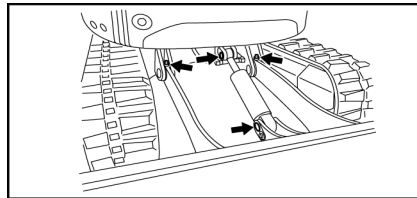
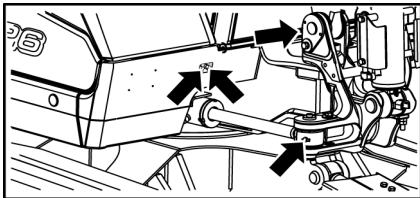
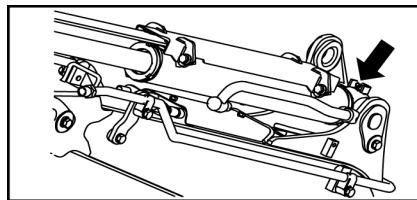
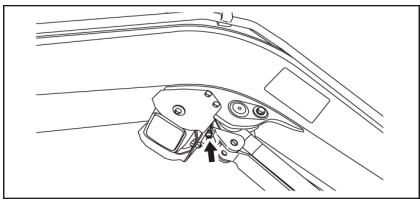
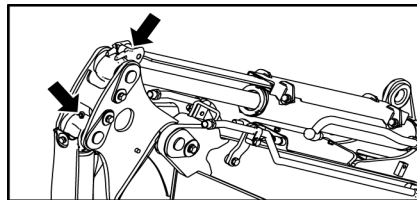
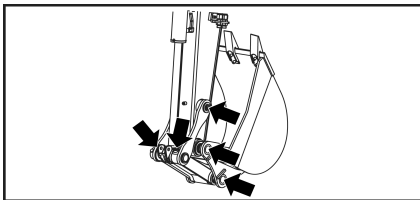



6 Maintenance by the operator

6.1.6 Using the centralized greasing system

- The timer is triggered at machine startup and stops at the machine's complete shutdown. When the ignition switch is turned off, the elapsed time before the next lubrication is saved and the timer restarts with this value when the machine is restarted.
- To refill the centralized greasing system, connect the grease pump on the filling connector nipple (B).

CAUTION

Do not plug the hole at the top of the tank in order not to block the filling.

DANGER

In case of over filling, the tank can burst and cause physical injuries.

- It is possible to manually start a lubrication in order to ensure proper greasing pump operation or if the machine needs an additional lubrication:
 - Press the switch in the cab.
 - Press the button located under both switches for 2 seconds until the LED on the right comes on.

Note

To access the timer, remove the cap located below the grease tank.

The lubrication cycle is shortened and the lubrication starts normally. Once the lubrication is carried out, the lubrication cycle restarts at zero.

6 Maintenance by the operator

6.1.7 Cleaning the separator/decanter

WARNING

Keep all sparks, flames or cigarettes away.

At operating temperature, the engine components are red hot and may cause burns.

Disconnect the battery mass and clean the separator when the engine has cooled down enough.

A diesel leak or spray onto a red hot element may cause a fire.

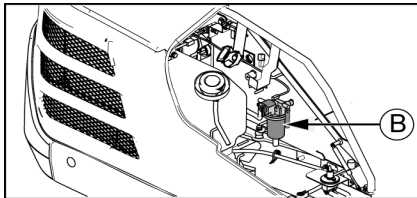

1. Open the rear bonnet.
 2. Place a container under the separator.
 3. Close the purge tap.
- B = Decanter/separator

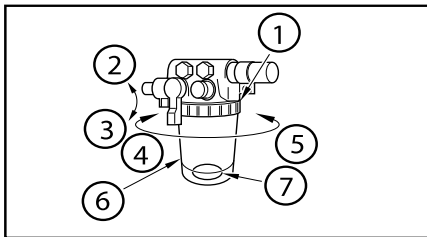

4. Loosen the bowl tightening ring.
- 1 = Tightening ring
2 = Closed
3 = Open
4 = Loosen
5 = Tighten
6 = Element
7 = Ring

5. Remove the bowl.
6. Empty into the container. Make sure you do not lose the red floater.
7. Remove the element and the holding ring.
8. Clean them and the inside of the bowl with clean diesel.
9. Check that the o-ring is not damaged or deformed. Replace it if necessary.
10. Refit the element and the bowl.
11. Open the tap.
12. Close the engine bonnet.

6 Maintenance by the operator

6.1.8 Purging the fuel tank

DANGER

Keep all sparks, flames or cigarettes away.

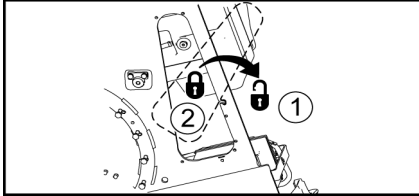

1. Pivot the upper structure so that the drainage cap under the fuel tank is opposite the blade between the two tracks.
2. Loosen the screws and rotate the bottom cover.
3. Place a container to catch the fuel residue under the drainage tap.
4. Remove the drainage cap to purge the water and dirt left in the tank.
5. Once clean fuel starts to come out, reinstall the drain plug and tighten to the right torque.

Maximum torque = 7Nm

WARNING

Do not exceed the torque indicated by the sticker on the tank.

6.1.9 Checking the hydraulic hoses

- Visually check that there are no oil leaks from the hydraulic hose connectors.

6.1.10 Visual inspection of the fuel hoses

- Visually check that the fuel does not leak from the fuel hose connectors.
- Also check that the hoses are not damaged. If there are any faults, contact your dealer.
- The fuel hoses must be changed every 2 years or every 2000 hours of service. Contact your dealer.

6.2 Maintenance every 50 hours

6.2.1 Greasing the pin and rotation crown

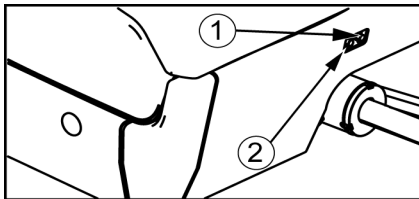

- Using a grease pump, grease the pin and the rotation crown at the greasers indicated with arrows on the figure opposite.

1 = Rotation crown

2 = Pin

- Slowly pivot the upper structure until it has made one complete turn.

WARNING

Do not pivot the upper structure during greasing. Grease and pivot alternately to avoid any injury.

6 Maintenance by the operator

6.3 Non periodic maintenance

6.3.1 Fuse replacement

1. Set the starter key to OFF position.
2. Remove the lid from the fusebox.
3. Identify the burnt out fuse.
4. Replace it with an equivalent fuse.

Fuse strip

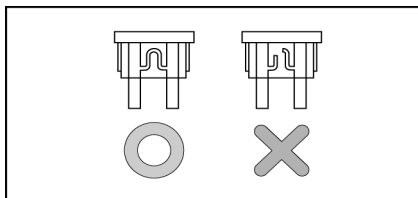

General supply fuses

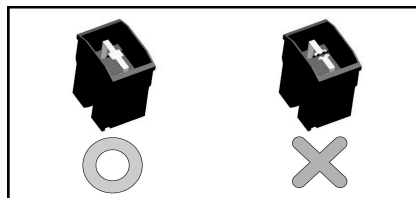

IMPORTANT

An unsuitable fuse or a fuse holder with a short circuit may cause overheating and damage the indicator gauges, the electric circuit or the cabling.

- If a fuse burns out immediately after it is replaced, this means there is a problem in the electric circuit. Contact your dealer for a diagnostic and an intervention.

6.3.2 Top up the windscreen washer fluid. (for cab)

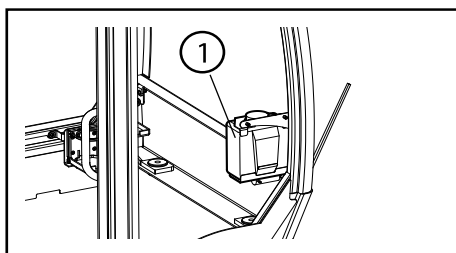

1. Open the windscreen washer tank. (1)
2. Top up the windscreen washer fluid. Do not over fill the windscreen washer tank.

IMPORTANT

Do not let any impurities into the tank.

6.3.3 Replacing the windscreen wiper (for cab)

- Replace the windscreen wiper when it no longer cleans the windscreen correctly. Follow the procedure indicated by the windscreen wiper manufacturer.

6.3.4 Accessory state check

- When working on an accessory, please contact your dealer or refer to the manufacturer user manual supplied with the accessory.

6 Maintenance by the operator

6.4 Rubber track maintenance

6.4.1 Checking the condition of the tracks

- The wear to the rubber tracks depends on the working conditions and the nature of the ground. Regularly check the wear and tension of the tracks.

Note

A new track must be checked for the first time after 30 hours.

Height of the fixing nuts

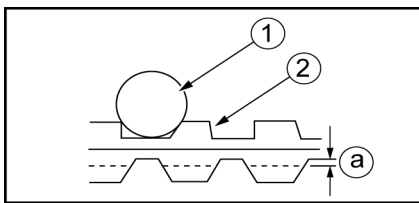

- If height A is reduced by wear, the traction power reduces.
- If A is lower than or equal to 5 mm, replace the track.

1 = Track roller

2 = Track

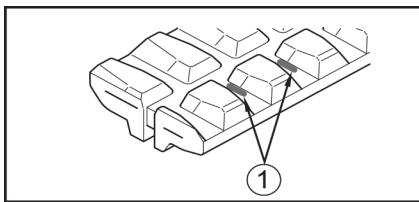

- If the track steel cables are uncovered over two or more joints, replace the tracks.
- If two or more links in the steel cable inside the track are exposed due to wear on the feet, replace the track.

1 = Exposed steel cables

Steel cables for the rubber tracks

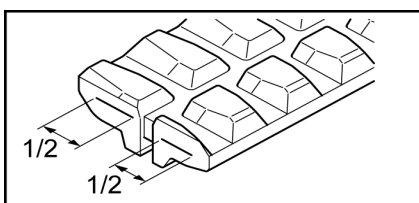

- If half or more of the cable bed is broken, replace the track.

Metal insert

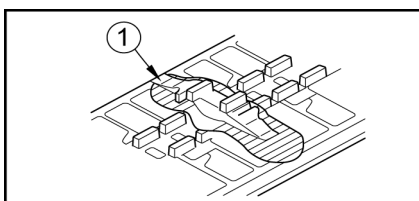

- If the metal inserts detach even at a single place, replace the track.

1 = Detachment of the metal insert

Greaser

- If the tracks are relaxed even after adjusting the tension, the lubrication nipple may have an internal failure. Contact your dealer for repair.

6 Maintenance by the operator

Crack

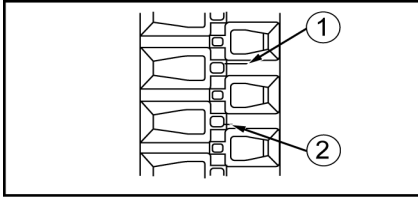

1 = Repair if over 60 mm

2 = Not yet to be repaired

- If a crack appears between the track attachment inserts, repair it if the length of the crack reaches 60 mm. If the interior steel cable is exposed, repair the track immediately even if the crack is a small one.

- If the length of the crack is less than 30 mm or if the depth of the crack is less than 10 mm, you do not need to repair the track.

- To find out whether the track must be replaced, repaired or you can continue to use it, contact your YANMAR dealer.

6.4.2 Track replacement

- If a track (or both tracks) needs to be replaced, contact your dealer.
- A new track must be checked for the first time after 30 hours.

6.4.3 Tension check

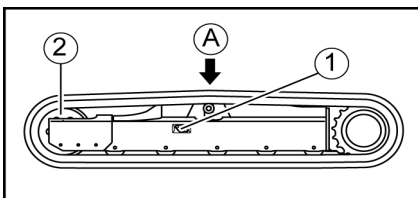

1. Move the machine so that the seal on the internal surface of the track is placed in the centre of the upper chassis.

A = Mark inside the track

1 = Cover

2 = Idle wheel

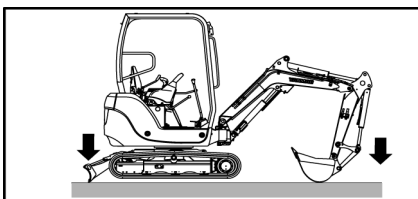

2. Raise the machine with the equipment by activating the command lever.

WARNING

Be sure to perform the track tension verification on a firm and even surface. It is strictly forbidden to be positioned under the machine for the duration of the operation.

6 Maintenance by the operator

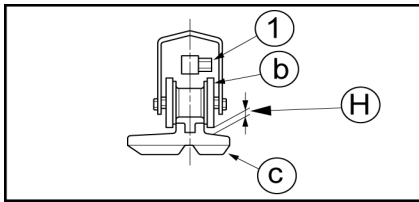

3. Check the tension. The play H between the external rolling surface of the second track roller on the tightener roller and the internal surface of the track must be 8 ~ 13 mm.

1 = Greaser

b = Track roller

c = Track

- If the tension is incorrect, follow the procedures given in the following chapters to increase or release the track tension.

IMPORTANT

Perform a task with a relaxed track link may derail the track or cause premature wear of the undercarriage.

6.4.4 Increasing the tension

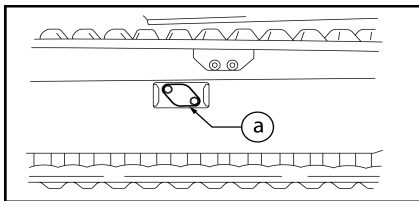

1. Prepare a grease pump.

2. Loosen the two screws and rotate the bottom cover to access the lubrication nipple.

a = Cover

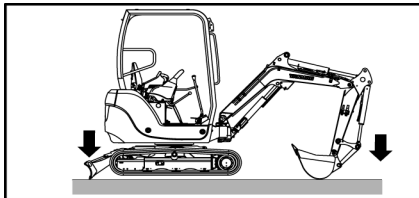

3. Raise the machine with the equipment by activating the command lever.

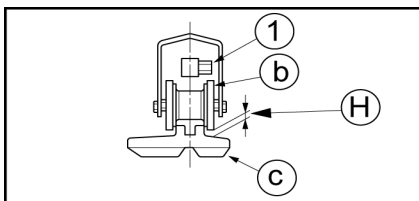

4. Using the grease pump, inject grease with the greaser so that the play H is between 8 ~ 13 mm.

1 = Greaser

b = Track roller

c = Track

5. Proceed with the track tensioning. To check that the tension is correct, put the machine down and move it gently forwards and back.

6. Check the tension again. If it is still not correct, adjust it again.

7. Re-install the cover.

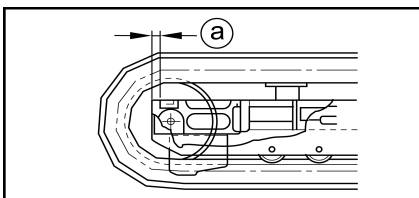

- The tension may be adjusted until the distance A is reduced to 0. If the voltage is still insufficient, the track must be replaced due to excessive wear. Contact your dealer for repair.

- If the tension is weak, even after grease is injected, the track must be replaced or a system tension check must be performed. Contact your dealer.

6 Maintenance by the operator

6.4.5 Releasing the tension

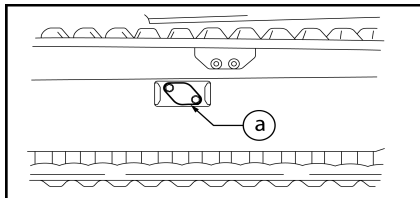

1. Loosen the two screws and rotate the bottom cover to access the lubrication nipple.

a = Cover

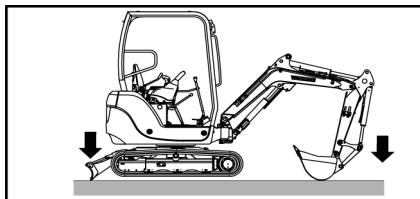

2. Raise the machine with the equipment by activating the command lever.

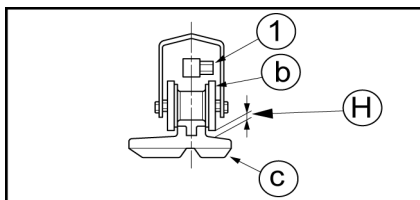

3. Loosen the greaser.

4. Let the grease escape so that the track will extend.

1 = Greaser

b = Track roller

c = Track

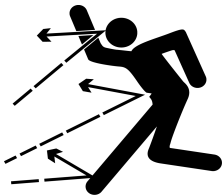

WARNING

Do not loosen the greaser by more than one turn. If it is loosened suddenly, the high pressure grease inside may escape or the valve may be ejected, which may cause serious injury.

When you check whether the grease has escaped, do not look inside the greaser but check that the track is released. Do not place your face, hand, legs or body in the direction of the greaser.

It is very dangerous to remove the grease using procedures other than those described here. If the track cannot be relaxed, ask your YANMAR dealer to intervene.

5. Tighten the greaser. Tightening torque : 49,0 N•m.
6. Proceed with the track tensioning.
7. Check the tension again. If it is still not correct, adjust it again.
8. Wipe off the excess grease with a cloth or equivalent.
9. Re-install the cover.

IMPORTANT

The rubber track does not resist grease. Wipe the grease off completely as it may reduce the life time of the rubber tracks.

6 Maintenance by the operator

6.5 Steel track maintenance

6.5.1 Checking the condition of the tracks

- The wear to the track pins and pegs depends on the working conditions and the nature of the ground. Check the track tension regularly to maintain suitable tension.
- Check and adjust the track tension under the same conditions as the operating conditions (for example, muddy conditions if the task is carried out on muddy ground).
- To find out whether the track must be replaced, repaired or you can continue to use it, contact your YANMAR dealer.

6.5.2 Track replacement

- If a track (or both tracks) needs to be replaced, contact your dealer.

6.5.3 Tension check

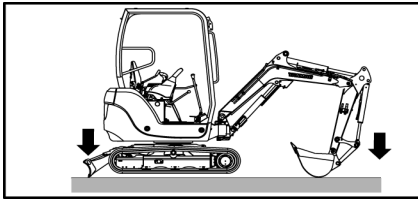

1. Raise the machine with the equipment by activating the command lever.

WARNING

Do not support the machine with the accessory only. The command levers may move or hydraulic oil may spill accidentally and cause the machine to fall.

When the machine is checked or adjusted by two people, one of them must commission the machine according to the signals given by the other person.

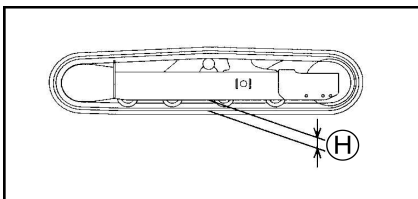

2. Check the tension. The play between the lower part of the lower chassis and the internal side of the machine must be 105 ~ 115 mm.

3. If the tension is incorrect, follow the procedures given in the following chapters to increase or release the track tension.

IMPORTANT

Perform a task with a relaxed track link may derail the track or cause premature wear of the undercarriage.

6 Maintenance by the operator

6.5.4 Increasing the tension

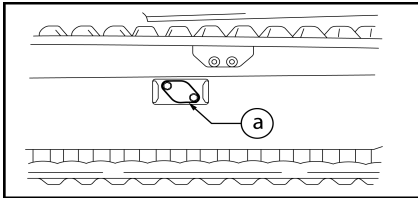

1. Prepare a grease pump.
2. Loosen the two screws and rotate the bottom cover to access the lubrication nipple.

a = Cover

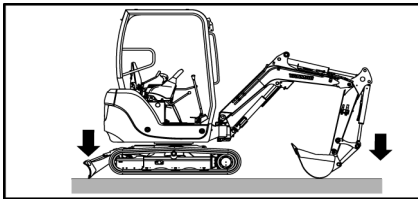

3. Raise the machine with the equipment by activating the command lever.

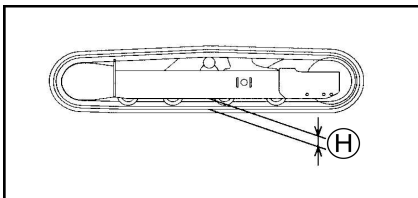

4. Using the grease pump, inject grease with the greaser so that the play H is between 105 ~ 115 mm.

5. To check that the tension is correct, put the machine down and move it gently forwards and back.
6. Check the tension again. If it is still not correct, adjust it again.
7. Re-install the cover.

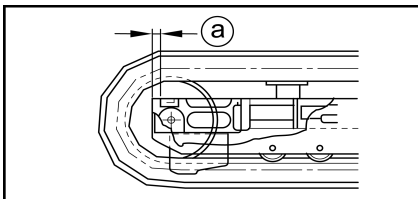

Note

The tension may be adjusted until the distance A is reduced to 0. If the tension is insufficient after being adjusted, the pin and the peg must be replaced. Contact your dealer for repair.

- If the tension is weak even after grease is injected, the track must be replaced. Contact your dealer.

6 Maintenance by the operator

6.5.5 Releasing the tension

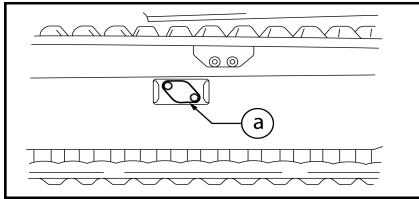

1. Loosen the two screws and rotate the bottom cover to access the lubrication nipple.

a = Cover

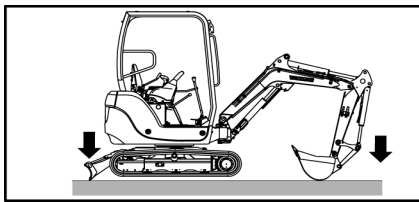

2. Raise the machine with the equipment by activating the command lever.

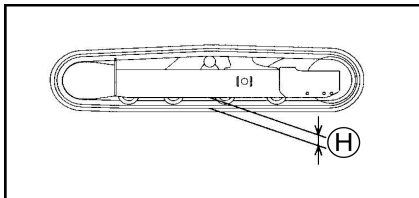

3. Loosen the greaser.

4. Let the grease escape so that the track will extend.

WARNING

Do not loosen the greaser by more than one turn.

If it is loosened suddenly, the high pressure grease inside may escape or the valve may be ejected, which may cause serious injury.



When you check whether the grease has escaped, do not look inside the greaser but check that the track is released. Do not place your face, hand, legs or body in the direction of the greaser.

It is very dangerous to remove the grease using procedures other than those described here. If the track cannot be relaxed, ask your YANMAR dealer to intervene.

5. Tighten the greaser. Tightening torque : 49,0 N•m.

6. To check that the tension is correct, put the machine down and move it gently forwards and back.

7. Check the tension again. If it is still not correct, adjust it again.

8. Wipe off the excess grease with a cloth or equivalent.

9. Re-install the cover.



7 MAINTENANCE BY THE DEALER

Frequency	1st time	Parts	Operations
Every 250h	–	Fuel filter	Replacement
	–	Alternator belt	Tension check
	–	Air filter ⁸	Cleaning
Every 500h	50h	Hydraulic oil return filter	Replacement
	50h	Engine oil	Replacement
	50h	Oil filter	Replacement
	–	Travel gears	Replenish engine oil
	–	Air filter	Replacement
	–	Radiator vents	Cleaning
Every 1000h	–	Hydraulic oil	Oil replacement
	50h	Travel gears	Oil replacement
	50h	Rotation reducer	Oil replacement
	–	Bearing rollers and bearings, idler wheels	Greasing
	–	Aspiration filter	Cleaning or replacement depending on the filter
	–	Alternator belt	Replacement
	–	Cooling fluid	Replacement
	–	Intake and exhaust valves	Play adjustment
	–	Heating	Check
	–	Fuel injection valve	Verification and adjustment
	–	Fuel pump	Check
	–	Battery electrolyte	Density check
	Every 2000h	–	Fuel hose, coolant hose
–		Injectors and injection pressure	Inspection and calibration
Non periodic	–	Cooling system	Cleaning

It is important to entrust the machine to a deal at the intervals indicated so that the dealer can carry out the maintenance operations necessary for the machine to operate correctly.

You should also contact your dealer in the following cases :

- part missing, broken or loose
- horn defective
- time counter defective

8. Dusty atmosphere



7 Maintenance by the dealer

- electric circuit defective
- battery defective
- light(s) defective

In general, contact your dealer as soon as you think something is wrong.



D Conservation and storage

CHAPTERS COVERED IN THIS CHAPTER:

- 1 CONSERVATION
- 2 STORAGE
- 3 RECOMMISSIONING

IMPORTANT

The conservation and storage of the machine must comply with standard NF ISO 6749 " Earth moving equipment, conservation and storage " of October 1987. The following chapters take part of the standard mentioned above but are not exhaustive. Refer to the standard for any additional information.





1 CONSERVATION

- Placing in conservation is intended to ensure the protection of the machine against corrosion from the environment and against minor damage that may occur during handling, transport and storage.
- Return the machine to good condition before placing it in conservation.
 1. Clean all the parts.
 2. Apply greasing oil and grease to the machine's metal surfaces and replace the engine oil.
 3. To avoid condensation in the fuel tank, drain the tank or fill it up.
 4. Apply a small quantity of rust protector to the exposed parts of the hydraulic cylinder rod.
 5. The battery must be disconnected. If the storage period exceeds one month, the battery must be removed and stored in a special room.
 6. Make sure the liquid in the cooling system has sufficient performance characteristics and is appropriate for the machine's storage temperatures.

 **3 Recommended greases and fluids, page 137**

If necessary, top up the water.

 **4.2 Checking and topping up the level of cooling fluid, page 81**

WARNING

Do not open the bonnet during machine operation. Verification and topping off of the various levels should be done when the engine is stopped and the temperatures are brought back down.

7. Lock the joysticks and pedals using locking levers and pedal protectors.

Note

The machine rusts easily if it is left near the sea or in a place exposed to sea winds. Apply rust protector to all the exposed parts of the piston rods and cover the machine with a polyethylene sheet or oiled paper. Certain rust protection solvents damage rubber materials. Make sure you use an adapted rust protector.

WARNING

When you place the machine in an enclosed space, ventilate by opening the doors and windows to avoid any gas intoxication.

2 STORAGE

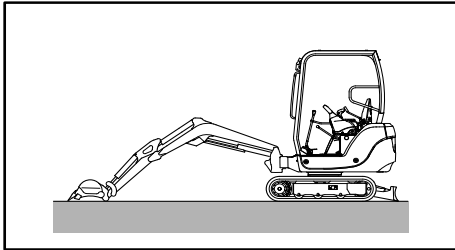

- You are recommended to store the machine in a closed and covered location.
- If the machine is stored outdoors, park it on flat ground and cover it with a protective sheet.
- The machine must be placed in the position illustrated opposite to protect the hydraulic cylinder rods against corrosion.

- In a long-term storage, move the machine at least once a month to form new oil on all the moving parts and remove the battery.
- When you do not use the machine for a period of over 3 months, avoid placing the tracks in a place that is directly exposed to sunlight or rain.
- The conservation and recommissioning instructions, as well as the conservation date must be placed in an impermeable envelope with a label and secured to the machine at a visible location.
- To protect the machine against rainwater, trap it to avoid accumulation of water that can promote corrosion of metal parts.

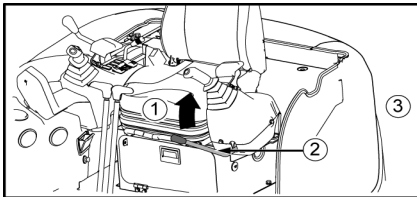

- The locking lever(s) must be in locked in a position to avoid any possibility of the machine being activated accidentally.

1 = Locking

2 = Locking lever

3= Left hand side

- The machine in prolonged storage must be regularly inspected in terms of its external appearance, the condition of the protected surfaces and the protection materials. The inspection intervals are the following :
 - every 6 months under temperate weather conditions,
 - every 3 months under tropical, cold, Arctica or coastal weather conditions.



3 RECOMMISSIONING

WARNING

After storage of the machine at temperatures outside the machine's operating temperature range, make sure the temperature is again in the operating temperature range before restoring the machine to working order.

Before using the machine again after a storage period of two months, do the following:

1. Remove the protections on the hydraulic cylinder rods.
2. Apply a large quantity of oil or grease to the moving part.
3. Drain the water from the fuel tank, from the engine oil casing and from the hydraulic fluid tank by removing the drainage caps.
4. Leave the machine to warm up after you start the engine.





E Technical data

CHAPTERS COVERED IN THIS CHAPTER:

- 1 SPECIFICATIONS
- 2 WORKING DIMENSIONS
- 3 NOISE EMITTED BY THE MACHINE
- 4 VIBRATIONS EMITTED BY THE MACHINE





1 SPECIFICATIONS

Tracks		Rubber / Steel	
H(track tension)	mm	8 ~ 13 / 105 ~ 115	
Elements		Canopy	Cabin

Weight (in conformity with CE standards)

Weight of the machine (with operator +75 kg)	kg	2535/2645	2675 / 2785
--	----	-----------	-------------

Working range and performance

Operating temperature range	°C	-15 ~ 40	
Bucket capacity, standard	m ³	0,06	
Bucket width, standard	mm	400	
Maximum depth	mm	2520	
Maximum vertical excavation depth	mm	920	
Maximum height reached	mm	3980	
Maximum dumping height	mm	2830	
Maximum range to ground	mm	4340	
Minimum turning radius forward <Rotation of the boom>	mm	1915 <1615>	
Boom rotation angle : left / right		45° / 75°	
Maximum excavation force : bucket / arm	kN	24,5 / 14,5	
Travel Speed : high/ low	km / h	4,8 / 2,9	
Maximum slope		30°	
Rotation speed	rpm	10,2	
Average pressure on the ground, standard track	kg / cm ²	0,30 / 0,32	0,33 / 0,34
Hydraulic pump rate	L / min	32,4x2; 21,6x1; 10,8x1	
Maximum hydraulic circuit pressure	MPa	P1 & P2 : 20,6 / P3 : 19,5 / P4: 2,94	





Engine : YANMAR 3TNV82A-BPBVA

Type	3 cylinders;water cooling;direct Diesel injection		
Power / revs	kW / rpm	17,6 / 2400	
Capacity	cm ³	1331	
Compression rate		19,1	
Alternator capacity	V / A	12 / 40	
Battery	V / Ah	12 / 56	

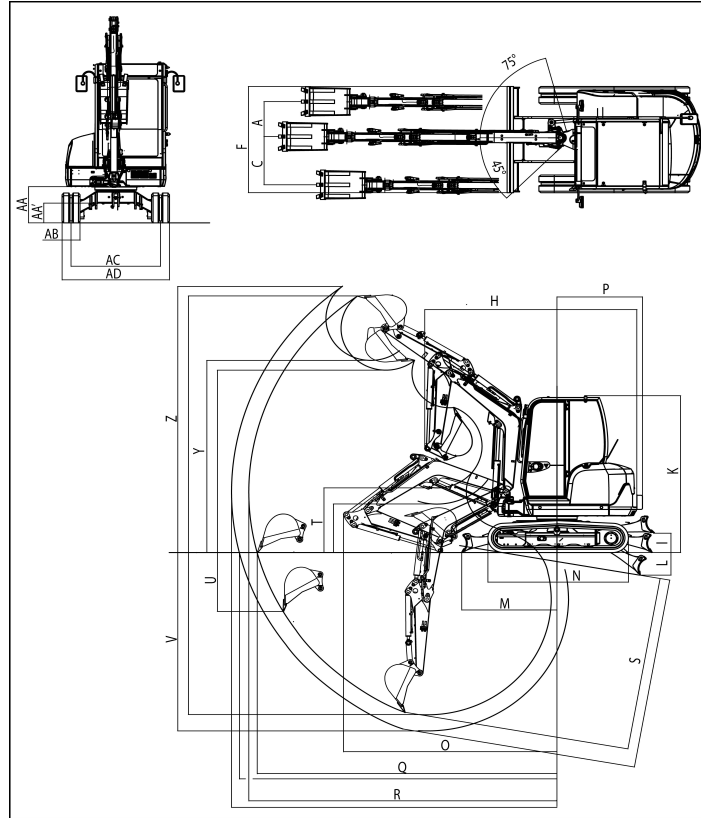
Dependent on technical modifications.

2 WORKING DIMENSIONS



Unit: mm						
A	495		R	4460	4710	
C	680		S	2685	2945	
F	1500		T	1005	755	
H <swing>	1915 <1615>		U	920		
I	300		V	2520	2770	
K	2435		Y	2830	2980	
L	350		Z	3980	4130	
M	1380		AA	540		
N	2030		AA'	320		
O	3090		AB	250		
P	1160		AC	1250		
Q	4340		AD	1500		
			1240 ⁹			
			4600			

9. With rear counterweight

3 NOISE EMITTED BY THE MACHINE

Examination results :



LwA (dBA)	94
LpA/LAeq (dBA)	76
LpCrête (dBC)	112

Rounded values

LwA : weighted acoustic power level A.

LpA/LAeq : weighted acoustic pressure level A on operator's ears.

LpCrête : maximum value of the instant acoustic pressure measured with frequency weighting C.

Measurements carried out :

- machine in static position
- machine running at nominal power

LwA : determined and guaranteed according to Directive 2000/14/CE amended by Directive 2005/88/CE.

LpA/LAeq : measured and guaranteed according to standard NF-ISO 6396: 1997.

These values are declared in accordance with Directive 2006/42/CE and do not correspond to exposure values over 8h of work.



4 VIBRATIONS EMITTED BY THE MACHINE

Declared vibration value in accordance with EN 12096			Unit : m/s ²
Vibrations	Work cycle	Measured vibration emission value, a	Uncertainty, K
Hand-arm in m/s ²	Roadworks trench	< 2,5	–
	Levelling	< 2,5	–
	Displacement	< 2,5	–
	Hydraulic hammer	< 2,5	–
Full body in m/s ²	Roadworks trench	0,59	0,13
	Levelling	0,99	0,19
	Displacement	0,80	0,15
	Hydraulic hammer	< 0,5	–
Values determined in accordance with standards ISO 5349-2 & NF EN 1032			
Work cycle	Work cycle definition		
Roadworks trench	So called excavation work; bucket movements digging in the soil (packed earth).		
Levelling	Advance with blade in the down position and move backward with blade raised; on packed earth.		
Displacement	Loop circuits on the gravel storage area (approximate speed 4km/h - 2.6 mi/h) clockwise turn.		
Hydraulic hammer	Operation of hydraulic rock breaker for 20 seconds on a steel plate of 100x50x5cm placed on the ground.		

Note

These values are declared in accordance with Directive 2006/42/CE and do not correspond to exposure values over 8h of work.

The following provisions should be taken in order to transmit the minimum amount of vibration to the whole body while the machine is operating and to avoid damaging the operator's health :

- Adjust the seat according to the operator's size.
- Keep the terrain in good condition.
- Use the machine under the conditions provided for, taking account of the real conditions of the terrain and the specific effects of the vibration that results from the actual operation of the machine.

The user must read and keep the instructions related to mounting and using accessories.



F Lifting capacities

CHAPTERS COVERED IN THIS CHAPTER:

- 1 LIFTING SV26 CABIN
- 2 LIFTING SV26 CANOPY

IMPORTANT

Using the machine as a hoist is subject to the Machinery Directive 2006/42/EC for members of the European Community, and to the legislations specific to each country for states outside the EC.

IMPORTANT

The capacities indicated in the following tables are determined for flat, firm ground. When the machine is not used on this type of ground, you should take account of these new conditions.

The machine's maximum weight allowed for dynamic operating conditions is determined by the most unfavourable cylinder extension and positioning conditions for the machine.

Depending on the machine configuration (arm length, presence of a counterweight...) and working conditions, the operator must make sure that the total weight of the quick coupler, the accessories used (bucket, hydraulic hammer...) and the load handled does not exceed the maximum weight allowed.

 10.1 Machine stability when using with a bucket or an accessory, page 99

IMPORTANT

The data in these tables represent the lifting capacity according to standard ISO 10567. They correspond to 75 % of the maximum static load before tipping or to 87 % of the hydraulic lifting force. The data marked with * show the hydraulic limits of the lifting force.

YANMAR CONSTRUCTION EQUIPMENT EUROPE S.A.S. declines all responsibility for any use of the machine that does not respect the instructions in this standard.

IMPORTANT

The position of the blade (raised or lowered) does not affect the machine's lifting capacity.

The lifting table indicates the maximum value that can lift the machine through a complete rotation of the turret.



1 LIFTING SV26 CABIN

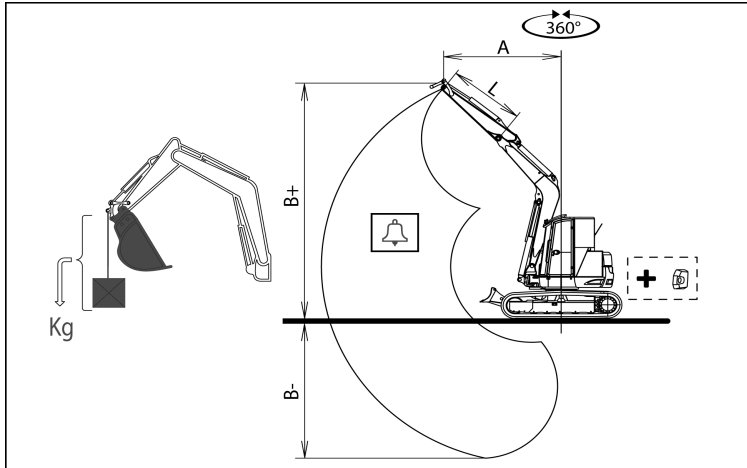

Machine with cab and rubber tracks.

A = Tilt from the rotation axis

B = Attachment point height (compared to the tracks)

C = Load weight

= Maximum load raised by the machine

= Housing overload alarm value setting

* = Hydraulic capacity limits of the lifting force

L = 1150mm					
B \ A	Max	3.5m	3m	2.5m	2m
2.5m	*515	-	*525	-	-
2m	415	*530	*560	*570	-
1.5m	380	430	*585	*705	*915
1m	370	420	515	680	860
0.5m	370	410	500	650	910
0m	370	400	495	640	885
-0.5m	375	400	500	645	905
-1m	430	-	500	640	780
-1.5m	*540	-	-	*580	*765

L = 1150mm						+ 100 kg
B \ A	Max	3.5m	3m	2.5m	2m	
2.5m	*515	-	*525	-	-	
2m	*535	*530	*560	*570	-	
1.5m	420	*550	*585	*705	*915	
1m	405	475	*695	*815	*1040	
0.5m	410	455	565	730	1010	
0m	420	460	570	720	1030	
-0.5m	435	455	555	700	990	
-1m	480	-	560	730	980	
-1.5m	*540	-	-	*580	*810	

L = 1400mm					
B \ A	Max	3.5m	3m	2.5m	2m
2.5m	*455	*465	*435	-	-
2m	365	*470	*480	-	-
1.5m	345	*495	*535	*610	-
1m	330	415	*620	*770	*1050
0.5m	335	410	510	655	920
0m	340	400	500	635	872
-0.5m	345	400	490	630	914
-1m	380	-	490	620	879
-1.5m	*560	-	-	*645	*825

L = 1400mm						+ 100 kg
B \ A	Max	3.5m	3m	2.5m	2m	
2.5m	*455	*465	*435	-	-	
2m	*470	*470	*480	-	-	
1.5m	390	*495	*535	*610	-	
1m	380	*545	*620	*770	*1050	
0.5m	380	465	570	*885	1020	
0m	390	460	570	720	990	
-0.5m	385	430	520	715	865	
-1m	425	-	525	700	915	
-1.5m	*560	-	-	*645	*830	

2 LIFTING SV26 CANOPY

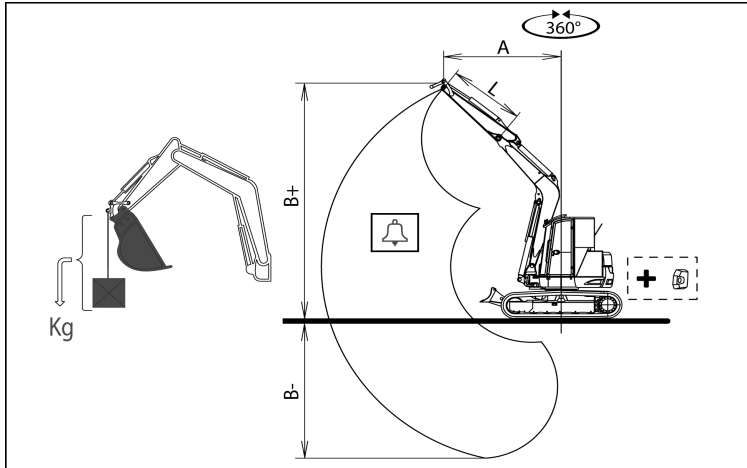

Machine with canopy and rubber tracks.

A = Tilt from the rotation axis

B = Attachment point height (compared to the tracks)

C = Load weight

= Maximum load raised by the machine

= Housing overload alarm value setting

* = Hydraulic capacity limits of the lifting force

L = 1150mm					
B \ A	Max	3.5m	3m	2.5m	2m
2.5m	405	-	*525	-	-
2m	375	*530	*560	*570	-
1.5m	345	390	455	550	*915
1m	330	380	465	615	775
0.5m	330	365	450	590	820
0m	335	365	450	575	800
-0.5m	335	360	450	580	820
-1m	385	-	450	575	695
-1.5m	410	-	-	*580	555

L = 1150mm						+ 100 kg
B \ A	Max	3.5m	3m	2.5m	2m	
2.5m	*515	-	*525	-	-	
2m	425	*530	*560	*570	-	
1.5m	390	440	*585	*705	*915	
1m	380	430	530	680	890	
0.5m	380	420	510	675	935	
0m	385	415	510	660	915	
-0.5m	385	415	510	665	930	
-1m	440	-	505	655	810	
-1.5m	*540	-	-	*580	670	

L = 1400mm					
B \ A	Max	3.5m	3m	2.5m	2m
2.5m	350	*465	-	-	-
2m	330	*470	*480	-	-
1.5m	310	*495	*535	*610	-
1m	300	375	470	*770	*1050
0.5m	300	375	460	590	835
0m	310	360	450	565	785
-0.5m	305	360	440	570	825
-1m	340	-	440	560	790
-1.5m	400	-	-	505	625

L = 1400mm						+ 100 kg
B \ A	Max	3.5m	3m	2.5m	2m	
2.5m	390	*465	-	-	-	
2m	375	*470	*480	-	-	
1.5m	355	*495	*535	*610	-	
1m	345	430	540	*770	*1050	
0.5m	345	425	525	675	950	
0m	355	410	515	650	900	
-0.5m	355	415	505	650	940	
-1m	395	-	500	640	910	
-1.5m	465	-	-	540	740	



Appendices

Additional informations:

- A List of error codes displayed on the operator display station
- B Control sheets to be photocopied
- C Notes
- D Lashing record



A List of error codes displayed on the operator display station

Error Code	Type	Description	Corrective actions
00 000091.00	CAUTION	Failure of the acceleration sensor	Maintenance required
00 000091.01	CAUTION	Failure of the acceleration sensor	Maintenance required
00 000091.02	CAUTION	Failure of the acceleration sensor	Maintenance required
00 000091.03	CAUTION	Failure of the acceleration sensor	Maintenance required
00 000091.04	CAUTION	Failure of the acceleration sensor	Maintenance required
00 000091.15	CAUTION	Failure of the acceleration sensor	Maintenance required
00 0000110.00	WARNING	Abnormal coolant temperature	 16 Detecting anomalies, page 119
00 0000110.02	WARNING	Coolant temperature sensor failure	Maintenance required
00 0000110.03	WARNING	Coolant temperature sensor failure	Maintenance required
00 0000110.04	WARNING	Coolant temperature sensor failure	Maintenance required
00 0000158.00	CAUTION	Abnormal supply voltage	Maintenance required
00 0000158.01	CAUTION	Abnormal supply voltage	Check the battery, or perform the maintenance
00 0000190.00	WARNING	Engine overspeed	Maintenance required
00 0000628.02	WARNING	Engine management ECU fault (FlashROM)	Maintenance required
00 0000628.12	WARNING	Engine management ECU fault (FlashROM)	Maintenance required
00 0000630.02	WARNING	Engine management ECU fault(EEPROM)	Maintenance required
00 0000630.12	CAUTION	(EEPROM)	Maintenance required
00 0000638.02	WARNING	Engine fault	Maintenance required
00 0000638.03	WARNING	Rack actuator	Maintenance required
00 0000638.04	WARNING	Rack actuator	Maintenance required
00 0000638.07	WARNING	Rack actuator	Maintenance required
00 0000639.12	CAUTION	CAN communication fault	Maintenance required
00 001078.04	WARNING	Speed sensor fault	Maintenance required
00 001079.02	CAUTION	Abnormal 5V power supply sensor	Maintenance required
00 001079.03	CAUTION	Abnormal 5V power supply sensor	Maintenance required
00 001079.04	CAUTION	Abnormal 5V power supply sensor	Maintenance required
00 001136.00	CAUTION	Abnormal temperature of engine internal management computer	Maintenance required
00 001136.02	CAUTION	Internal management computer temperature sensor fault	Maintenance required
00 001136.03	CAUTION	Internal management computer temperature sensor fault	Maintenance required
00 001136.04	CAUTION	Internal management computer temperature sensor fault	Maintenance required
00 001210.03	WARNING	Rack position sensor fault	Maintenance required



00 001210.04	CAUTION	Rack position sensor fault	Maintenance required
00 001485.04	CAUTION	Engine management ECU main relay fault	Maintenance required
00 522241.02	CAUTION	Rack actuator relay fault	Maintenance required
00 522241.03	WARNING	Rack actuator relay fault	Maintenance required
00 522241.0	WARNING	Rack actuator relay fault	Maintenance required
00 522242.02	CAUTION	Cold start assistance system fault	Maintenance required
00 522242.03	CAUTION	Cold start assistance system fault	Maintenance required
00 522242.04	CAUTION	Cold start assistance system fault	Maintenance required
00 522243.02	CAUTION	Heater relay fault	Maintenance required
00 522243.03	CAUTION	Heater relay fault	Maintenance required
00 522243.04	CAUTION	Heater relay fault	Maintenance required
00 522251.03	CAUTION	RGE step-by-step motor fault	Maintenance required
00 522251.04	CAUTION	RGE step-by-step motor fault	Maintenance required
00 522252.03	CAUTION	RGE step-by-step motor fault	Maintenance required
00 522252.04	CAUTION	RGE step-by-step motor fault	Maintenance required
00 522253.03	CAUTION	RGE step-by-step motor fault	Maintenance required
00 522253.04	CAUTION	RGE step-by-step motor fault	Maintenance required
00 522254.03	CAUTION	RGE step-by-step motor fault	Maintenance required
00 522253.04	CAUTION	RGE step-by-step motor fault	Maintenance required
00 522727.12	CAUTION	Engine management ECU fault (sub CPU fault)	Maintenance required
00 522727.12	CAUTION	Engine management ECU fault (sub CPU fault)	Maintenance required
00 522727.12	CAUTION	Engine management ECU fault (sub CPU fault)	Maintenance required
00 522728.12	WARNING	Engine management ECU fault (map information error)	Maintenance required
28 000096.02	CAUTION	Fuel sensor fault	Maintenance required
28 000096.04	CAUTION	Fuel sensor fault	Maintenance required
28 000100.00	WARNING	Abnormal engine oil pressure	 16 Detecting anomalies, page 119
28 000167.01	CAUTION	Insufficient battery charge	 16 Detecting anomalies, page 119
28 000639.12	WARNING	CAN communication fault	Maintenance required
28 520777.02	CAUTION	Failure of the hydraulic oil temperature sensor	Maintenance required
28 520777.04	CAUTION	Failure of the hydraulic oil temperature sensor	Maintenance required
28 520805.12	WARNING	CAN communication fault	Maintenance required
E1 025088.02	CAUTION	Hydraulic management ECU fault (ROM error)	Maintenance required
E1 025088.12	CAUTION	Hydraulic management ECU fault (EEPROM)	Maintenance required
E1 025600.09	CAUTION	CAN communication fault	Maintenance required
E1 026112.12	CAUTION	Hydraulic management ECU fault	Maintenance required





E1 026368.12	CAUTION	Engine management ECU fault	Maintenance required
E1 030464.05	CAUTION	Proportional pump solenoid valve fault	Maintenance required
E1 030464.06	CAUTION	Proportional pump solenoid valve fault	Maintenance required
E1 033024.00	CAUTION	Abnormal voltage of the management computer power supply (top)	Maintenance required
E1 033024.01	CAUTION	Abnormal voltage of the management computer power supply (bottom)	Check the battery, or perform the maintenance
E1 033024.11	CAUTION	Abnormal voltage of the management computer power supply (bottom)	Check the battery, or perform the maintenance





B Control sheets to be photocopied

Photocopy the following sheets and carry out maintenance on your machine according to the number of hours of service.

Control sheet: Maintenance every 50 hours			
Number of hours of service		hours	
Parts	Operations	Done by	the
Rotation pin and crown	Greasing	 6.2.1 Greasing the pin and rotation crown, page 146	

Control sheet: Maintenance every 50 hours			
Number of hours of service		hours	
Parts	Operations	Done by	the
Rotation pin and crown	Greasing	 6.2.1 Greasing the pin and rotation crown, page 146	

Control sheet: Maintenance every 50 hours			
Number of hours of service		hours	
Parts	Operations	Done by	the
Rotation pin and crown	Greasing	 6.2.1 Greasing the pin and rotation crown, page 146	

Control sheet: Maintenance every 50 hours			
Number of hours of service		hours	
Parts	Operations	Done by	the
Rotation pin and crown	Greasing	 6.2.1 Greasing the pin and rotation crown, page 146	

Control sheet: Maintenance every 50 hours			
Number of hours of service		hours	
Parts	Operations	Done by	the
Rotation pin and crown	Greasing	 6.2.1 Greasing the pin and rotation crown, page 146	



Control sheet: Maintenance every 250 hours			
Number of hours of service		hours	
Parts	Operations	Done by	the
Rotation pin and crown	Greasing	Dealer	
Side movement and acceleration levers	Verification and adjustment		
Air filter ¹⁰	Cleaning		
GO filter	Replacing the element		

Control sheet: Maintenance every 250 hours			
Number of hours of service		hours	
Parts	Operations	Done by	the
Rotation pin and crown	Greasing	Dealer	
Side movement and acceleration levers	Verification and adjustment		
Air filter ¹⁰	Cleaning		
GO filter	Replacing the element		

Control sheet: Maintenance every 250 hours			
Number of hours of service		hours	
Parts	Operations	Done by	the
Rotation pin and crown	Greasing	Dealer	
Side movement and acceleration levers	Verification and adjustment		
Air filter ¹⁰	Cleaning		
GO filter	Replacing the element		

Control sheet: Maintenance every 250 hours			
Number of hours of service		hours	
Parts	Operations	Done by	the
Rotation pin and crown	Greasing	Dealer	
Side movement and acceleration levers	Verification and adjustment		
Air filter ¹⁰	Cleaning		
GO filter	Replacing the element		

10. Dusty atmosphere



Control sheet: Maintenance every 500 hours			
Number of hours of service		hours	
Parts	Operations	Done by	the
Rotation pin and crown	Greasing	Dealer	
Rotation reducer	Replenish engine oil		
Travel gears	Replenish engine oil		
Engine oil	Replacement		
Oil filter	Replacement		
Radiator vents	Cleaning		
Side movement and acceleration levers	Verification and adjustment		
Hydraulic oil return filter	Replacement		
GO filter	Replacement		
Air filter	Replacement		

Control sheet: Maintenance every 500 hours			
Number of hours of service		hours	
Parts	Operations	Done by	the
Rotation pin and crown	Greasing	Dealer	
Rotation reducer	Replenish engine oil		
Travel gears	Replenish engine oil		
Engine oil	Replacement		
Oil filter	Replacement		
Radiator vents	Cleaning		
Side movement and acceleration levers	Verification and adjustment		
Hydraulic oil return filter	Replacement		
GO filter	Replacement		
Air filter	Replacement		

Control sheet: Maintenance every 500 hours			
Number of hours of service		hours	
Parts	Operations	Done by	the
Rotation pin and crown	Greasing	Dealer	
Rotation reducer	Replenish engine oil		
Travel gears	Replenish engine oil		
Engine oil	Replacement		
Oil filter	Replacement		
Radiator vents	Cleaning		
Side movement and acceleration levers	Verification and adjustment		
Hydraulic oil return filter	Replacement		
GO filter	Replacement		
Air filter	Replacement		



Control sheet: Maintenance every 1000 hours / Every year			
Number of hours of service		hours	
Parts	Operations	Done by	the
Rotation pin and crown	Greasing	Dealer	
Rotation reducer	Oil replacement		
Travel gears	Oil replacement		
Hydraulic oil	Replacement		
Bearing rollers and bearings, idler wheels	Greasing		
Engine oil	Replacement		
Oil filter	Replacement		
Aspiration filter	Cleaning or replacement depending on the filter		
Radiator vents	Cleaning		
Belt	Replacement		
Side movement and acceleration levers	Verification and adjustment		
Hydraulic oil return filter	Replacement		
Battery electrolyte	Density check		
GO filter	Replacement		
Cooling fluid	Replacement		
Intake and exhaust valves	Verification and adjustment		
Fuel injection valve	Verification and adjustment		
Cylinder head block	Bolt re-tightening		
Air filter	Replacement		
Heating system	Verification and adjustment		



Control sheet: Maintenance every 1000 hours / Every year			
Number of hours of service		hours	
Parts	Operations	Done by	the
Rotation pin and crown	Greasing	Dealer	
Rotation reducer	Oil replacement		
Travel gears	Oil replacement		
Hydraulic oil	Replacement		
Bearing rollers and bearings, idler wheels	Greasing		
Engine oil	Replacement		
Oil filter	Replacement		
Aspiration filter	Cleaning or replacement depending on the filter		
Radiator vents	Cleaning		
Belt	Replacement		
Side movement and acceleration levers	Verification and adjustment		
Hydraulic oil return filter	Replacement		
Battery electrolyte	Density check		
GO filter	Replacement		
Cooling fluid	Replacement		
Intake and exhaust valves	Verification and adjustment		
Fuel injection valve	Verification and adjustment		
Cylinder head block	Bolt re-tightening		
Air filter	Replacement		
Heating system	Verification and adjustment		



Control sheet: Maintenance every 2000 hours / Every two years			
		Number of hours of service	hours
Parts	Operations	Done by	the
Rotation pin and crown	Greasing	Dealer	
Rotation reducer	Oil replacement		
Travel gears	Oil replacement		
Bearing rollers and bearings, idler wheels	Greasing		
Hydraulic oil	Replacement		
Engine oil	Replacement		
Oil filter	Replacement		
Aspiration filter	Cleaning or replacement depending on the filter		
Radiator vents	Cleaning		
Belt	Replacement		
Side movement and acceleration levers	Verification and adjustment		
Hydraulic oil return filter	Replacement		
Battery electrolyte	Density check		
GO filter	Replacement		
Cooling fluid	Replacement		
Fuel injection valve	Verification and adjustment		
Cooling system	Cleaning		
Fuel hose, coolant hose	Verification and replacement		
Intake and exhaust valves	Verification and adjustment		
Fuel pump	Adjustment check		
Cylinder head block	Bolt re-tightening		
Air filter	Replacement		
Injectors and injection pressure	Verification and adjustment		
Heating system	Verification and adjustment		



C Notes

D Lashing record

	<p>YANMAR CONSTRUCTION EQUIPMENT EUROPE S.A.S 25, rue de la Tambourine 52100 SAINT-DIZIER CEDEX FRANCE + 33 (0) 3 25 56 39 75</p>																												
GENERAL PRINCIPLE OF APPLICATION																													
Road transport	Model : SV26 Type of operation: Tie-down																												
	<p>Activity: Earthmover Group: Shovel Subgroup: Tracked excavator Category: Mini tracked excavator Size: L.= 4250mm /l.= 1500mm / H.= 2440mm</p>																												
<p>⚠ WARNING</p> <p>Do not perform the tie-down if a person stands on the machine or on an accessory.</p> <p>Use a tie-down accessory (belt, chain, cable) compatible with the weight of the machine and compliant with European standards.</p>																													
<p>The tie-down process is defined based on the characteristics of a trailer with a Maximum Authorised Total Weight (MATW) of 3500kg</p> <ol style="list-style-type: none"> 1. Check the condition of the transport vehicle surface. If the surface is greasy, it must be cleaned before installing the machine on the transport vehicle. 2. Check the location and condition of the machine tie-down points. 3. Tie-down the machine at the points provided for that purpose and that are indicated on the machine. 																													
<p>⚠ DANGER Blocking of turret (provided by the brake) Additional accessories (bucket, arm, etc) Rigging Tension in lashing accessories Measure the loading height Grip on truck bed (frost, snow...)</p> <p>* Using additional rigging accessories depends on the nature of the contact between the device and the transport vehicle and the weather conditions. Please refer to the machine user manual.</p> <p> 15.3 Tying down the machine, page 115</p> <p>Reference standards <i>NF EN 474-1+A1:2009 et PR NF ISO 15818:2013</i></p> <p>Created: 13/11/2013 Updated: 13/11/2013-</p>	<table border="1" style="width: 100%; border-collapse: collapse;"> <tr> <td colspan="2" style="text-align: center; font-weight: bold;">DEVICE</td> </tr> <tr> <td style="width: 60%;">Weight of the vehicle (kg)</td> <td style="text-align: center;">2410-2710</td> </tr> <tr> <td colspan="2" style="text-align: center; font-weight: bold;">DEVICE CARRIER DEVICE</td> </tr> <tr> <td>Nature of the contact</td> <td style="text-align: center;">Steel-wood</td> </tr> <tr> <td>Angle range α</td> <td style="text-align: center;">20°-60°</td> </tr> <tr> <td>Angle range β</td> <td style="text-align: center;">10°-60°</td> </tr> <tr> <td colspan="2" style="text-align: center; font-weight: bold;">ACCESSORIES</td> </tr> <tr> <td style="width: 60%;">Wedge (Lengthwise direction FR)</td> <td style="text-align: center;">NON*</td> </tr> <tr> <td>Wedge (Lengthwise direction RR)</td> <td style="text-align: center;">NON*</td> </tr> <tr> <td>Wedge (Lateral direction)</td> <td style="text-align: center;">NON*</td> </tr> <tr> <td>Slip resistant mat</td> <td style="text-align: center;">NON*</td> </tr> <tr> <td>Tie-down accessories</td> <td style="text-align: center;">4</td> </tr> <tr> <td colspan="2" style="text-align: right; font-weight: bold;">WLL¹¹ min (daN)</td> </tr> <tr> <td colspan="2" style="text-align: center;">3000</td> </tr> </table>	DEVICE		Weight of the vehicle (kg)	2410-2710	DEVICE CARRIER DEVICE		Nature of the contact	Steel-wood	Angle range α	20°-60°	Angle range β	10°-60°	ACCESSORIES		Wedge (Lengthwise direction FR)	NON*	Wedge (Lengthwise direction RR)	NON*	Wedge (Lateral direction)	NON*	Slip resistant mat	NON*	Tie-down accessories	4	WLL ¹¹ min (daN)		3000	
DEVICE																													
Weight of the vehicle (kg)	2410-2710																												
DEVICE CARRIER DEVICE																													
Nature of the contact	Steel-wood																												
Angle range α	20°-60°																												
Angle range β	10°-60°																												
ACCESSORIES																													
Wedge (Lengthwise direction FR)	NON*																												
Wedge (Lengthwise direction RR)	NON*																												
Wedge (Lateral direction)	NON*																												
Slip resistant mat	NON*																												
Tie-down accessories	4																												
WLL ¹¹ min (daN)																													
3000																													

¹¹ Working Load Limit (WLL)



INDEX

3rd hydraulic circuit 112

A

Accessing the machine 65
 Accessories 101
 Accessories 147
 Accessories 105
 Accessories
 Dismantling 53
 Accessories
 Dismantling 107
 adhesive labels 6
 adhesive labels 42
 Applications 3
 Ash tray 31

B

Basic precautions 59
 Battery
 Battery charge warning alert 15
 Battery
 discharged 123
 Battery charge warning alert
 Battery 15
 Blade lever 27
 Bonnet 55
 Box oil 137

C

Cab side door 32
 Cabin's emergency exit 62
 Centralized greasing system 46
 Check the position of the blade 65
 Checking the commands 142
 Checks
 before starting 80
 Checks after start-up 87
 Cigar lighter 19
 Circuit breaker 56
 Comparison between rubber tracks / steel
 tracks 95
 Conservation 159
 Cover B 56
 Covers 55

D

Daily maintenance 142
 Detecting anomalies 119
 Diesel
 type 137
 Diesel gauge 16
 Dismantling
 Accessories 53
 Dismantling
 Accessories 107
 Door 32
 Driver's seat 27
 Driving the machine on a slope 67

E

Engine oil 137

F

fuel
 type 137
 Fuses 29

G

Greasing
 Greasing points 143

H

Headlights 35
 Horn 20
 Hydraulic oil
 type 137
 Hydraulic oil
 Replenishment 85
 Verification 85

I

Interior lighting switch 21

J

Joysticks and pedals 22



L

Left command lever.....	24
Lifting.....	3
Lifting capacities.....	169
Lifting Kit.....	40
Lifting ring.....	41
Locking lever.....	23

M

Maintenance every 50 hours.....	146
Mechanical quick coupler.....	47
Mounting	
Accessories.....	53
Mounting the accessory.....	108
Movement alarm.....	42

O

Opening of the upper part of the windscreen	
.....	32
Options.....	37

P

Power socket.....	27
Precautions	
use of equipment.....	69
Precautions	
Optional parts and tools.....	62
Precautions	
Use.....	63
Precautions	
Before starting the engine.....	63
Precautions	
Displacement.....	66
Precautions	
Work.....	69
Precautions	
Parking.....	75
Precautions	
Accessories.....	77
Precautions	
Battery.....	78
Precautions for using optional accessories ..	77
Precautions for using rubber tracks.....	95
protective structures for the cabin.....	64

Q

Quick coupler.....	46
--------------------	----

R

Recommissioning.....	161
Right command lever.....	23
Right hand cab window.....	34
Rubber track maintenance.....	147
Rubber tracks.....	95
Running in.....	79

S

Safety signals.....	
Soldering.....	135
Specifications.....	165
Start key.....	18
Steel track maintenance.....	152
Stopping the engine.....	76
Storage.....	160

T

Technical data.....	163
tension.....	149
Time counter.....	16
Towing the machine.....	126
Transporting the machine.....	114
Travel	
Levers.....	25
Pedal.....	25

U

Überprüfungen nach dem Gebrauch der Maschine.....	142
Use	
Maintenance.....	131
use of equipment	
Precautions.....	69
User manual.....	28

V

Ventilation switch.....	20
-------------------------	----

W

Windscreen washer.....	20
Windscreen wiper switch and windscreen wiper	
Windscreen wiper.....	20
Work	
Precautions.....	69



MINI EXCAVATOR

YANMAR

YANMAR CONSTRUCTION EQUIPMENT EUROPE S.A.S

<http://www.yanmar.eu>



RENTAL
EQUIPMENT
FOR
CONSTRUCTION
AND
INDUSTRIAL
PURPOSES

RENTAL
EQUIPMENT
FOR
CONSTRUCTION
AND
INDUSTRIAL
PURPOSES

RENTAL
EQUIPMENT
FOR
CONSTRUCTION
AND
INDUSTRIAL
PURPOSES

RENTAL
EQUIPMENT
FOR
CONSTRUCTION
AND
INDUSTRIAL
PURPOSES