



Operator manual

(Original instructions)

Manual del operario

(Traducción de las instrucciones originales)

Manuel de l'opérateur

(Traduction des instructions originales)

Benutzerhandbuch

(Übersetzung der Originalanweisungen)

Handleiding operator

(Vertaling van de oorspronkelijke instructies)

en (English)

es (Español)

fr (Français)

de (Deutsch)

nl (Nederlands)



Table of Contents

1 INTRODUCTION	en-3		
1.1 FOREWORD	en-3		
1.1.1 Models covered by this manual	en-3		
1.1.2 About this manual	en-3		
1.1.3 Manufacturer	en-3		
1.2 SAFE USE.....	en-3		
1.2.1 Before starting operation	en-3		
1.2.2 Visibility test	en-4		
1.2.3 Emergency stop	en-5		
1.2.4 Emergency switch off.....	en-5		
2 OVERVIEW	en-6		
2.1 MAIN COMPONENTS.....	en-6		
2.2 TRUCK IDENTIFICATION	en-6		
2.2.1 Truck serial number	en-6		
2.2.2 Identification plate	en-6		
2.3 LOAD AND STABILITY	en-6		
2.3.1 Truck stability	en-6		
2.3.2 Load centre of gravity	en-6		
2.3.3 Maximum lift height	en-7		
2.3.4 Actual capacity	en-7		
2.4 WARNING LABELS	en-7		
2.4.1 Warning labels description	en-7		
2.4.2 Warning labels position	en-10		
2.5 MAIN FUNCTIONS	en-11		
2.5.1 S.A.S. (System of Active Stability)	en-11		
2.5.2 O.P.S. (Operator Presence Sensing)	en-14		
2.5.3 Parking brake off warning	en-14		
2.5.4 Low speed setting	en-14		
2.5.5 Maximum speed limiter	en-15		
2.5.6 Speed reduction when cornering	en-15		
2.5.7 Maximum speed and acceleration reduction (Option)	en-15		
2.5.8 Seat belt lock recognition	en-16		
2.5.9 Auto-off function	en-16		
2.5.10 Emergency stop button	en-16		
2.5.11 Height selector (Option).....	en-16		
2.5.12 l_Site (Option)	en-16		
2.5.13 Shock sensor (Option).....	en-17		
2.5.14 Pre-operational check (Option).....	en-17		
3 OPERATION	en-18		
3.1 OPERATING CONTROLS	en-18		
3.2 BODY COMPONENTS	en-18		
3.2.1 Operator's seat	en-21		
3.2.2 Armrest	en-22		
3.2.3 Battery hood	en-22		
3.2.4 Overhead guard	en-22		
3.2.5 Lights	en-23		
3.2.6 Cabin	en-24		
3.2.7 Safety gates (Option).....	en-24		
3.2.8 Load handling system.....	en-26		
3.3 SWITCHES AND LEVERS	en-26		
3.3.1 Mini levers	en-29		
3.3.2 Multifunction levers	en-32		
3.3.3 Multifunction joystick (Option).....	en-35		
3.3.4 Steering column.....	en-37		
3.3.5 Pedals.....	en-38		
3.3.6 Parking brake	en-38		
3.3.7 Rear assist grip with horn button (Option)	en-38		
3.4 INSTRUMENTS PANEL	en-38		
3.4.1 Dashboard	en-40		
3.4.2 Display indicators	en-42		
3.4.3 Alarms	en-44		
3.4.4 Operator settings menu	en-46		
3.4.5 PIN code entry system (Option)	en-47		
3.4.6 Smart Card reader (Option).....	en-47		
3.5 INSPECTIONS.....	en-47		
3.5.1 Inspection recommendations.....	en-47		
3.5.2 Pre-operation inspections	en-50		
3.5.3 Post-operation inspections	en-50		



Table of Contents

4 SELF SERVICING	en-51
4.1 WEEKLY MAINTENANCE	en-51
4.1.1 Planned maintenance recommendations	en-51
4.1.2 Hub nuts retightening	en-51
4.1.3 Battery terminals	en-51
4.1.4 Heater filter cleaning	en-52
4.1.5 Air convoyer filter cleaning	en-52
4.1.6 Lubricants and fluids	en-52
4.2 EXTRAORDINARY OPERATIONS	en-55
4.2.1 Tires replacement	en-55
4.2.2 Battery replacement	en-56
4.2.3 Fuses replacement	en-57
4.2.4 Hoisting	en-58
4.2.5 Transport	en-59
4.3 TROUBLESHOOTING	en-60
4.3.1 Truck misalignment	en-60
4.3.2 Blown fuse	en-60
4.3.3 Stuck fork carriage	en-60
4.3.4 Fork carriage emergency lowering	en-60
4.3.5 Towing the truck	en-61
5 TECHNICAL DATA	en-62
5.1 TECHNICAL SERVICING	en-62
5.1.1 Technical servicing indications	en-62
5.1.2 Periodic replacements	en-62
5.1.3 Periodic maintenance	en-63
5.2 NOISE AND VIBRATIONS LEVEL	en-66
5.3 TRUCK DIMENSIONS	en-66
5.4 TRUCK WEIGHT	en-67



1 INTRODUCTION

1.1 FOREWORD

1.1.1 Models covered by this manual

Series	Capacity kg	Load centre mm
6.0 t	6000	600
7.0 t	7000	600
8.0 t	8000	600
8.0 t - H	8000	900

1.1.2 About this manual

This manual contains information essential for proper operation and maintenance. Please read this manual thoroughly, even though you may already be familiar with our forklift trucks, because it contains information which is exclusive to this series of trucks.

This manual is based on a standard truck model. If you have questions about other model(s), please contact the Service Centre.

Service Centre shall be intended as a service centre authorized by the forklift truck manufacturer.

This manual is divided into five main chapters: **Introduction** reports general information about this manual and correct use of a counterbalanced forklift truck.

Overview contains information about truck plates, labels and main features, most of them related to your safety.

Operation explains how to use and inspect your truck.

Self servicing shows you how to perform self-servicing on your truck, ranging from regular weekly maintenance to troubleshooting.

Technical data contains useful data related to your truck's characteristics, such as dimensions and weight; you'll also find information about the servicing intervals that a specialized service technician will apply in order to keep your truck at peak efficiency.

In addition to this manual, please be sure to read the separate publication entitled "Manual for Safe Operation." It contains important information about the safe operation of forklift trucks.

We are constantly developing our products. We therefore reserve the right to make modifications at anytime without prior notice. Illustrations may differ from actual design. Some features may be set differently from the standard functionality described in this manual; please refer to the Service Centre.

1.1.3 Manufacturer

Toyota Material Handling Europe AB
Svarvargatan 8
S-59581 Mjölby
Sweden

1.2 SAFE USE

1.2.1 Before starting operation

- **Please read the Operator Manual and the Manual for Safe Operation thoroughly.** This will give you a complete understanding of your forklift truck and enable you to operate them correctly and safely. Proper handling of a new truck promotes performance and extends service life. Operate with special caution while becoming familiar with a new truck. In addition to the standard operating procedures, pay attention to the following safety items.
- **Please acquire a thorough knowledge of your forklift truck.** Read the operator's manual thoroughly prior to operating the truck. Get to know its operation and components. Learn about the safety devices and accessory equipment and their limits and precautions. Be sure to read the warning labels attached to the truck.
- **Please familiarize yourself with safe operating points and safe maintenance operation.** Understand and maintain work



1 INTRODUCTION

area traffic rules. Ask the work area supervisor about any special working precautions.

- **Wear appropriate clothing for operation.** Improper clothing for truck operation may interfere with smooth operation and cause an accident. Always wear appropriate clothing for easier operation.
- **Please keep away from live electric power lines.** Know the locations of inside and outside power lines and maintain sufficient distance.
- **Be sure to perform inspections and planned maintenance.** This will prevent sudden malfunctions, improve work efficiency, save money and insure a safe working operation.
- **Be sure to avoid forward tilt when the forks are elevated with a load.** In the worst case, this may cause overturning due to loss of stability resulting from forward movement of the center of gravity.
- **Never attempt traveling and turning with a load on the forks when they are elevated.** If traveling and turning when the forks are elevated, this may impact stability and may cause the fork lift to tip-over. When traveling, maintain a fork height above the ground of 10-20cm (6-8 inches).
- **Please avoid overloading or uneven loading.** Overloading or an uneven load is dangerous. If the centre of gravity is not evenly distributed, the heaviest side of the load should be against the fork carriage/load backrest even if the load is less than that specified on the nameplate. Also, the load should have the heaviest weight closest to the forks with lighter items on the top.
- **If you hear any unusual noise or sense anything unusual, stop, inspect and repair immediately.**
- **Please use only the recommended types of lubricants** Low-grade lubricants will shorten service life.

- **Never attempt to remove or modify any component.** Please contact the Service Centre.
- **When washing the truck, be careful not to splash water directly on the motor or electrical components.** If the motor or electrical parts are splashed directly with water, the forklift truck may malfunction or break down. If the truck is in such a state that washing becomes unavoidable, cover electrical parts with a panel of insulating material so as to prevent them getting wet.
- **Do not make any modifications to the electrical circuit.** Any attempt to do so may affect the safety and operation of the devices built into the battery-operated forklift truck, causing a malfunction or accident. If modifications become necessary, contact the Service Centre.
- For trucks equipped with non-marking tires, a static strap shall be fitted.
- Do not let the battery run down completely. Always check the condition of the battery.
- **Keep naked flames away during the battery charge procedure.** Combustible gas is produced during charging. Charge in a well-ventilated open area, away from naked flames.
- If thunder is heard in the distance, stop recharging the battery and unplug the charger cable. If thunder is heard overhead, do not touch the plug or the cable as these could deliver an electric shock if lightning were to strike nearby. It is strongly advisable to wire lightning conductors or voltage limiters into the electrical circuit in locations where thunderstorms are commonplace.

1.2.2 Visibility test

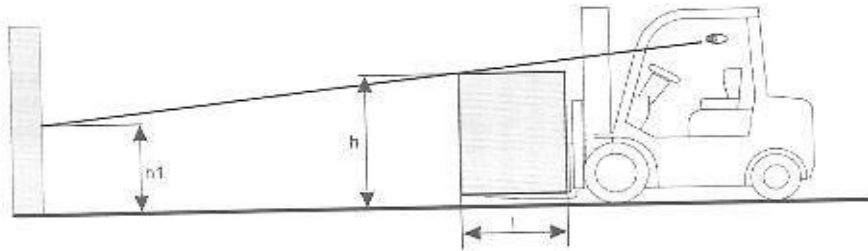

Apply the following formula to estimate the maximum allowed load height in order to ensure the minimum required forward visibility ($h1$) from operator's eye position. If your load height exceeds h , you must travel in reverse.

$$h = n - l \times m$$

h - maximum allowed load height (from the ground)

l - load length

m, n - truck specific parameters

NOTICE

This simplified formula is valid for standard truck configurations only. Otherwise, please refer to Visibility Test described in the Manual for Safe Operation.

1.2.2.1 Visibility truck parameters

Truck model	m	n
6.0 t	0.224	1983
7.0 t - 8.0 t	0.224	1981
8.0 t - H	0.223	1975

1.2.3 Emergency stop

In case of an emergency that requires the immediate stop of the truck, fully depress the brake pedal.

In case of brake devices malfunctions, press the Emergency stop button.

1.2.4 Emergency switch off

In case of an emergency that requires to disconnect the power (such as flames or smoke coming out from the truck), stop the truck and press the Emergency stop button.



2 OVERVIEW

2 OVERVIEW

2.1 MAIN COMPONENTS

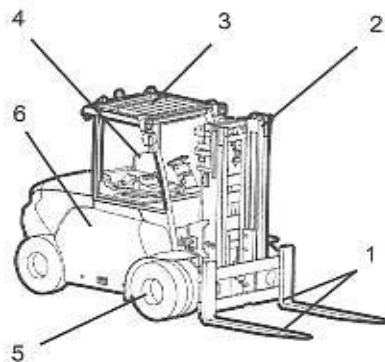

- (1) Forks
- (2) Mast
- (3) Overhead guard
- (4) Operator's seat
- (5) Front wheel
- (6) Battery hood
- (7) Steering wheel
- (8) Counterweight
- (9) Rear wheel
- (10) Oil tank panel
- (11) Rear hood

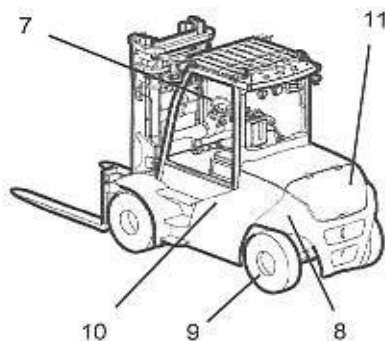

2.2 TRUCK IDENTIFICATION

2.2.1 Truck serial number

The truck serial number is stamped on the right side of the truck frame, under the battery side hood. Refer to the serial number when making inquiries about your truck.

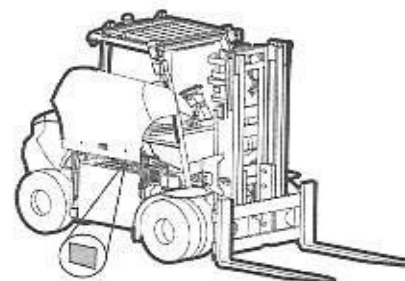

2.2.2 Identification plate

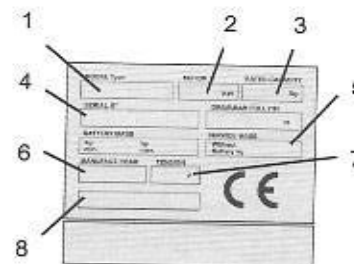

- (1) Model
- (2) Motor power
- (3) Rated capacity
- (4) Serial number
- (5) Weight
- (6) Year of manufacture
- (7) Battery voltage
- (8) Notes

2.3 LOAD AND STABILITY

2.3.1 Truck stability

The truck exceeds the test requirements laid down by the reference directives and standards, assuring a sufficient degree of stability under normal working conditions with correct and reasonable use. The stability of the truck is affected by the ground characteristics, tires, general maintenance conditions and the type of use.

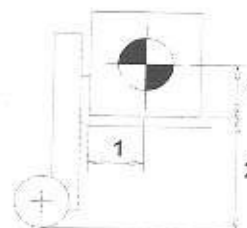

- (1) Load centre of gravity
- (2) Maximum lift height



2.3.2 Load centre of gravity

Indicates the distance of the centre of gravity of the load, measured horizontally on the front side of the fork heel and vertically on the upper side of the fork.

2.3.3 Maximum lift height

Maximum lift height is the highest position of the forks with the mast in the vertical position. The arrow symbol indicates the current lift height (available only for masts with max. lift height of more than 3300 mm).

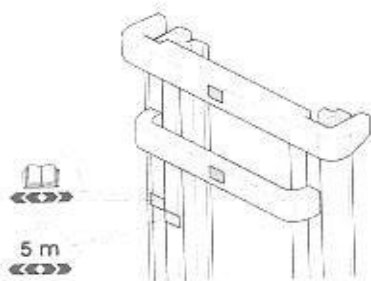

2.3.4 Actual capacity

Indicates the maximum load the truck can carry, lift and stack at specified height, distance from centre of gravity and extension values (where applicable) during normal operation.

Actual capacity plate

- (1) Special model, Attachment model
- (2) Tires
- (3) Serial number
- (4) Load center
- (5) Lifting height
- (6) Actual capacity

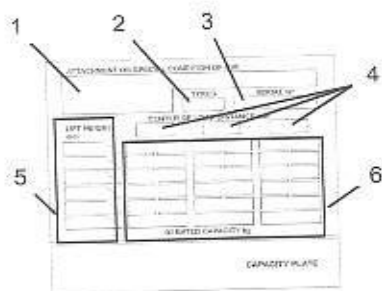

⚠ WARNING

Fitting other attachments or changing the tire type or other components, affects the other values shown. In this case the plate must be replaced.

2.4 WARNING LABELS

2.4.1 Warning labels description

The following labels are just for reference. Some of them may not be fitted in your truck. Some pictures can differ in detail from actual labels. This list doesn't include labels not related to truck features and functions.

2

Read the Manuals

Warning! Please read this Operator Manual and the Manual for Safe Operation carefully before use.

Risk of electric shock

Please read this Operator Manual and the Manual for Safe Operation carefully before use.

Seat belt

Please read this Operator Manual for reference.

Parking brake

Please read this Operator Manual for reference.

Load lift height

Please read this Operator Manual for reference.

Hydraulic oil

Please read this Operator Manual for reference.

Brake fluid

Please read this Operator Manual for reference.

Pneumatic tires

Please read this Operator Manual for reference.





2 OVERVIEW



No welding

Warning! No welding may be performed on the truck. Please read this Operator Manual and the Manual for Safe Operation carefully.

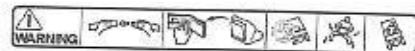

Risk of tip over

Tip over can cause serious injury or death. Lookout for and avoid the hazards that cause them and use the seat belt. If your truck tips, stay in the seat, lean away from the tipping direction, hang on, and brace your feet.



Risk of crushing

Caution! Risk of crushing hands or fingers.



Battery hood: risk of crushing

Caution! Risk of crushing hands or fingers between battery hood and overhead guard.



Battery side stopper: risk of crushing

Caution! Risk of crushing hands or fingers when positioning the battery side stopper.



Stay clear from forks

Warning! Do not pass under raised forks or stand on lowered forks.



Do not step up

Warning! Do not step on the tilt cylinder.



Non ionizing radiations

Warning! Please read this Operator Manual carefully before use.



Hot surface

Caution! Risk of burning when this surface is hot.



Break window

In case of emergency, if the cabin door cannot be opened, use the fitted hammer to break this side window for getting off the forklift truck.



Load handling

Warning! Do not tilt the mast forward to store the load. Do not travel with lifted load.



Parking brake lever

Parking brake lever enabling and disabling procedure. Please read this Operator Manual for reference.

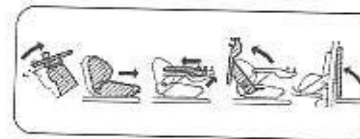

Battery hood opening

Battery hood opening procedure. Please read this Operator Manual for reference.

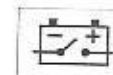

Disconnect battery

Disconnect the battery before performing maintenance. Please read this Operator Manual and the Manual for Safe Operation carefully.



Battery stopper

Please read this Operator Manual for reference.



Fuses position

Please read this Operator Manual for reference.



Hoisting

Truck hoisting procedure. Please read this Operator Manual for reference.



Lifting point

Lifting point for truck hoisting. Please read this Operator Manual for reference.



Securing point

Securing point for truck transport. Please read this Operator Manual for reference.



Horn

Please read this Operator Manual for reference.



Low speed

Low speed function. Please read this Operator Manual for reference.



Power mode

Power mode selector. Please read this Operator Manual for reference.



Height limiter

Height limiter function. Please read this Operator Manual for reference.



Travel direction

Travel direction selector. Please read this Operator Manual for reference.



Load lift

Mast lower and raise. Please read this Operator Manual for reference.



Load tilt

Mast tilt. Please read this Operator Manual for reference.



Sideshift

Please read this Operator Manual for reference.

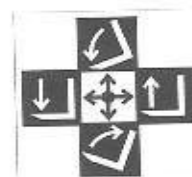

Load multifunction

Mast lower, raise and tilt multifunction. Please read this Operator Manual for reference.



Sideshift multifunction

Please read this Operator Manual for reference.



Text labels

The following labels add textual explanations to pictures. Be sure to read them thoroughly. The samples show the english version.

Crushing - Shock

Risk of crushing hands and of electric shock.



SAS

Truck equipped with SAS. The sample shows the swing lock version.



OPS

Truck equipped with OPS.



2 OVERVIEW



Seat switch



Electric equipment

Unauthorized modifications to the truck may compromise the electric equipment.

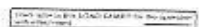

Load chart

Don't refer to the load chart for the operation with attachment.



Sideshift operation



Fork extension installation



Checklist

Inspection, maintenance and lubrication checklist.

Special design attachments labels

Extendable forks

extend / retract



Telescopic forks

extend / retract



Fork positioner
spread out / move in



Fork rotator
rotate clockwise / rotate counterclockwise



Clamp
open / close

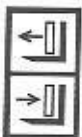

Push-Pull
extend / retract



Trilateral
rotate left / rotate right

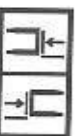

Trilateral
shift left / shift right



2.4.2 Warning labels position

- (1) Read the Manuals
- (2) Risk of electric shock
- (3) Load lift height
- (4) Hydraulic oil
- (5) Risk of tip over
- (6) Risk of crushing
- (7) Stay clear from forks
- (8) Do not step up
- (9) Non ionizing radiations
- (10) Hot surface
- (11) Break window
- (12) Fuses position
- (13) Hoisting
- (14) Lifting point
- (15) Securing point
- (16) Horn
- (17) Height limiter
- (18) Travel direction
- (19) Sideshift
- (20) Load multifunction
- (21) Sideshift multifunction
- (22) Crushing - Shock
- (23) SAS
- (24) Seat switch
- (25) Electric equipment
- (26) Load chart

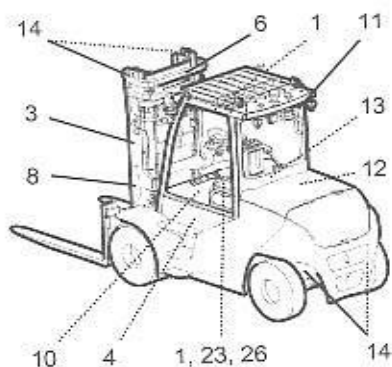
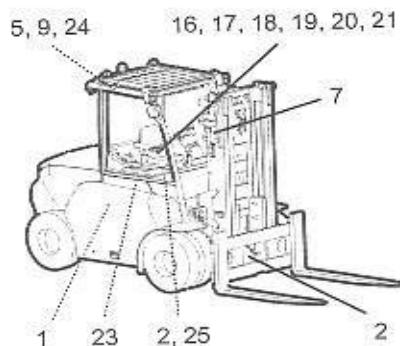

2.5 MAIN FUNCTIONS

2.5.1 S.A.S. (System of Active Stability)

Precautions on SAS

Whenever you use a forklift equipped with SAS, check the warning labels to determine which SAS features your truck has been equipped with. Do not operate the truck if any SAS feature is not operating properly.

The following are examples of the warning labels which will be affixed on SAS equipped trucks to identify the SAS features installed on that specific truck.

- Active steering control
- Active mast function control

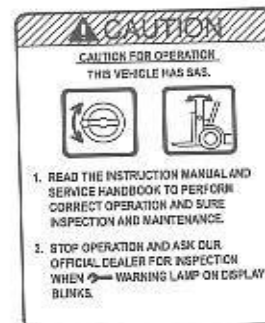

- Active steering control
- Active control rear stabilizer (swing lock cylinder)
- Active mast function control

⚠ DANGER

Forklifts equipped with SAS will operate and handle differently than similar forklifts without SAS. Operators must use caution when changing between trucks with and without SAS features. Operation of forklifts without SAS in the same manner as forklifts with SAS can result in loss of control and potential tip over.



⚠ CAUTION

Before operating a truck equipped with SAS, familiarize yourself with the SAS feature or features and be sure that no error code is shown on the display.

- While operating a truck equipped with SAS, should an error code be indicated on the display, park the truck in a safe location, apply the parking brake and have the truck inspected by the Service Centre.
- The SAS is electronically controlled. The system may need to be initialized after completion of maintenance.
- Do not remove or modify the SAS features. If inspection of the SAS is required, ask the Service Centre.
- When washing the truck, caution is required to prevent water from being directly applied to the electrical parts used in the SAS. These electrical parts include a controller, sensors and switches.
- Once you have fitted or replaced any attachment on a forklift, ask the Service Centre for an inspection and load rating if required.
- If you use two or more removable attachments alternately, the heaviest one should be used to carry out matching (SAS setting). Ask the Service Centre to request compatibility matching.
- When mounting forks or attachments to a truck without forks, the attachments must be compatible with the model. Ask the Service Centre to request compatibility matching.

Description of SAS features

Automatic fork leveling control

When moving the tilt lever forward while pressing the automatic fork leveling switch, the forks will stop automatically at the horizontal position (the mast positioned vertically).

When moving the tilt lever backward while pressing the automatic fork leveling switch, the forks will also stop automatically at the horizontal position (the mast positioned vertically).

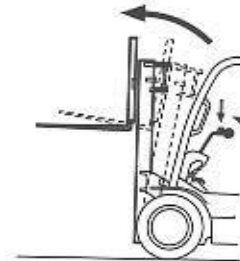

		Not Loaded	Loaded
Forward tilt	High Lift Height (Over 6 feet or 2 m)	Stop at the horizontal position (with mast positioned vertically)	Not tilt forward
	Low Lift Height	Stop at the horizontal position (with mast positioned vertically)	Stop at the horizontal position (with mast positioned vertically) or up to 1° backward depending on the load
Backward tilt	High Lift Height (Over 6 feet or 2 m)	Stop at the horizontal position (with mast vertically positioned)	Stop at the horizontal position (with mast positioned vertically) or up to 1° backward depending on the load
	Low Lift Height	Stop at the horizontal position (with mast vertically positioned)	Stop at the horizontal position (with mast positioned vertically) or up to 1° backward depending on the load

NOTICE

- To cancel the Automatic fork leveling control in the middle of operation, release the automatic fork leveling switch.
- After stopping the forks at the horizontal position with the tilt lever knob switch pressed, you may want to tilt the forks further forward or backward. Return the tilt lever to the neutral position once. Then, after releasing the automatic fork leveling switch, move the tilt lever again.

⚠ CAUTION

- When you move the tilt lever forward while pressing the tilt lever knob switch or the automatic fork leveling switch, with a load at



at a high lift height, the mast will stop moving suddenly. Avoid such operation, because the truck may tip over.

- A heavy attachment may affect a forklift truck equipped with automatic fork leveling control. Ask the Service Centre before installing this type of attachment.

Active mast forward tilt angle control

This function automatically limits the forward tilt angle of the mast depending on the load weight and lift height.

	Light Load (no load)	Medium Load	Heavy Load
High Lift Height (Over 6 feet or 2 m)	No limitation for forward tilt angle	Forward tilt angle limited from 1° to 5° degrees	Forward tilt angle limited to 1° degree
Low Lift Height	No limitation for forward tilt angle		

⚠ CAUTION

- This feature is intended to enhance the stability of the forklift under certain conditions, but cannot prevent the forklift from tipping forward or the load from falling off under all circumstances. You must continue to use caution when operating the forklift.
- When you lift a load from a low lift height with the mast tilted forward, the active mast forward tilt angle control does not work. Avoid such operation, because the truck may tip forward.
- Never tilt the mast beyond its vertical position with a load at a high lift height, or the truck may tip forward, losing its stability forward or backward.
- Even with a load within the allowable capacity, tilting the mast beyond its vertical position with a load elevated may cause tip-over

as the center of gravity shifts forward and upward. Never tilt the mast forward when a load is elevated.

- A heavy attachment may affect a forklift truck equipped with active mast forward tilt angle control. Ask the Service Centre before installing this type of attachment.
- Once you have replaced forks with any attachment, have the truck inspected by the Service Centre.
- If you use two or more removable attachments alternately, the heaviest one should be used to carry out matching (SAS setting). Ask the Service Centre for help in advance.
- When attaching forks or attachment to a forkless model, the attachments must be compatible with the model. Ask the Service Centre to request compatibility matching (SAS setting).
- This feature can be influenced by the load weight centre of gravity. Be sure the load is correctly positioned within the allowed load centre value. Please refer to the LOAD AND STABILITY section of this manual.

2

NOTICE

When forks are at the maximum lift height, high pressure (relief pressure) may remain in the lift cylinder. This will cause the truck to detect that it has a heavy load even if there is no load. As a result, the tilt forward angle is limited. In such case, lower the mast slightly to tilt the mast forward.

Active mast backward tilt speed control

This function automatically reduces the backward tilt speed of the mast at a lift height higher than approximately 6 feet (2 m) in order to prevent the load from shifting.

- At a high lift height, the backward tilting speed is automatically limited regardless of the load weight. When lowering from a high



lift height to a lower lift height while tilting the mast backward, the tilting speed will not change.

- At a low lift height, the backward tilting speed is not limited even if there is a load. When lifting from a low lift height to a higher lift height while tilting the mast backward, the tilting speed will not change.
- When operating the tilt lever backward while pressing the tilt knob switch at any lift height, the backward tilting speed is limited as long as the tilt lever knob switch is pressed (except trucks equipped with Mini lever or Joy stick).

2.5.2 O.P.S. (Operator Presence Sensing)

The OPS prevents traveling and load handling operations when the operator is not properly seated in the truck for more than 2 seconds.

Description of OPS features

Travel OPS function

If the operator leaves the seat while the truck is traveling, the OPS indicator will be shown on the display and travel operations will be stopped after 1,5 seconds. If the operator returns to the normal seating position within 1,5 seconds, traveling can be continued.

To restart operations, return accelerator pedal, travel direction switches or levers, and all load handling levers to the neutral position and sit in the seat.

CAUTION

OPS stops powered travel, but does not apply the brake.

Load handling OPS function

If the operator leaves the seat for 1,5 seconds or more during load handling operations, the OPS indicator will be shown on the display and

load handling operations will be stopped. If the operator returns to normal seating position within 1,5 seconds, load handling operation can be continued.

If the operator leaves the seat while operating the control lever, lowering operation can be continued for 1,5 seconds.

To restart operations, return all levers and pedals to the neutral position and sit in the seat.

CAUTION

If you operate the attachment lever when the OPS is activated, the attachment might move or lower by its own weight.

Should a problem with OPS occur

A malfunction may have occurred to the OPS if:

- The OPS indicator does not go on when the operator is not seated in the normal operating position.
- The OPS indicator does not go off when the operator is seated the normal operating position.
- A display alarm notifies the operator.

For details of this function, please refer to the DISPLAY INDICATORS and ALARMS sections of this manual.

If any anomaly is found, park the truck in a safe location, apply the parking brake, remove the key and ask the Service Centre for an inspection.

2.5.3 Parking brake off warning

If the operator leaves the truck or turns off the truck without applying the parking brake, a warning sound will warn the operator. The parking brake will automatically apply.

2.5.4 Low speed setting

This function limits the maximum traveling speed to a preset value. For details of this function, please refer to the DASHBOARD section of this manual.





The setting value of the low speed can be changed on the display Menu. For details of this function, please refer to the OPERATOR SETTINGS MENU section of this manual.

CAUTION

This function shall not be used to decrease the speed while driving, or for braking the truck. This function must be only activated from standstill.

NOTICE

Depending on factors such as truck weight, mast type, climatic conditions and uphill travel, the set speed may not be attained.

The setting level of low speed setting cannot be set above the setting level of maximum speed limitation.

2.5.5 Maximum speed limiter

This function limits the maximum traveling speed to a preset value.

The setting value of the maximum speed limiter can be changed on the display by the administrator.

NOTICE

Depending on the truck weight, the set speed may not be attained while traveling uphill.

2.5.6 Speed reduction when cornering

Top speed is reduced automatically when the truck negotiates a bend.

This function may be fitted as standard or option, depending on truck models.

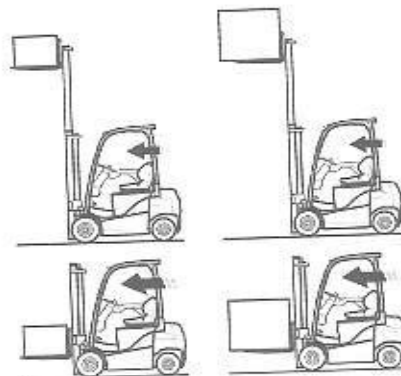

Lifting height	Light or no load	Heavy load
High	Unaltered braking	The braking is reduced according to the load weight
Reduced	Unaltered braking	

2.5.7 Maximum speed and acceleration reduction (Option)

This function automatically limits the maximum speed, acceleration and deceleration by detecting the forks height (Low/High) and the loaded weight, reducing the possibility of falling of loads. Uneven ground can cause speed and acceleration variations.

Regenerative braking works according to the weight load.

2

DANGER

- Safe driving is always necessary. The auto speed control helps to prevent the risk of tilting but does not completely eliminate all risk.
- When loads are lifted high, never step on the accelerator pedal suddenly, or never shift the truck from the neutral to driving condition with keeping the accelerator pedal stepped on.

Settings

This function can only be enabled/disabled by an administrator. When enabled, the auto speed control indicator is shown on the display.

This function exclusively controls the acceleration/deceleration, without limiting the maximum speed. In this case, the auto speed control indicator is shown with the colours inverted.





The maximum speed is controlled within an interval between unlimited speed and 8 km/h. If the low speed setting is enabled, the lower value is taken as a reference.

The deceleration limitation is disabled in the following cases:

- truck speed less than 3 km/h
- brake pedal microswitch is pressed
- for models with Balanced Pedal (Option), when the accelerator pedal in the direction opposite to the travel direction is pressed firmly.

2.5.8 Seat belt lock recognition



This function checks that the seat belt is correctly fastened; if not, the seat belt lock recognition indicator will be shown on the display and travel operations will be stopped. If the truck is stationary, it will not start; if on the move, it will stop. The truck will remain disabled until the belt has been fastened correctly.

This function may be fitted as standard or option, depending on truck models.

2.5.9 Auto-off function

All systems of the truck will shut down after a preset time if the operator vacates the driving position (with the parking brake applied).

This function may be fitted as standard or option, depending on truck models.

Service Centre can set the auto-off function time.

2.5.10 Emergency stop button

The Emergency stop button blocks all truck functions. The button is self-locking, and must be lifted before resuming normal operation.

This device may be fitted as standard or option on certain truck models.

WARNING

For details of this function, please refer to the EMERGENCY STOP section of this manual.

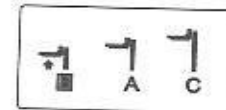

NOTICE

The Emergency stop button is an additional device and it's not designed to be used in place of the brake pedal or to turn OFF the truck in non-emergency situations.

2.5.11 Height selector (Option)

This option consists of three functions that automatically stop the forks at the required height as follows.

Maximum height limiter

The administrator can set a lift height limit value. Consequently, the forks can't be raised over that limit.

Height limiter

The operator can set a lift height limit value. Consequently, the forks can't be raised over that limit. The operator can enable/disable this function using the height limiter switch. For details of this function, please refer to ARMREST section of this manual.

Automatic height control

The operator can memorize a maximum of three lift heights. Using the automatic height control switch the operator can enable one of the memorized heights. Consequently, the forks can't be raised over that limit.

If the maximum height limiter or the height limiter is set, the positions memorized of the Automatic Height Control may be higher than the height limited by them. In this case the higher positions memorized by the automatic height control are not shown on the screen and cannot be selected. The heights memorized will be available again when the maximum height limiter or the height limiter are disabled.

2.5.12 I_Site (Option)

The device is type-approved for use on GSM 900/1800 and 3G/4G networks. During installation, operation, servicing and repairs, the following safety regulations must be complied with. The non-compliance with these regulations constitutes a breach of the safety standards of





the design, production and foreseen use of the product. The manufacturer shall not be liable for any consequences deriving from the non-compliance with these safety precautions.

This device emits radio waves during operation; the unit may interfere with the operation of televisions, radios, computers or other unprotected devices.

WARNING

- Risk of interference with medical appliances. The I_{site} emits radio waves in the same way as mobile phones and may therefore cause interference with medical appliances. Such interference may compromise patient safety. If the I_{site} is used near medical appliances, the same rules and precautions established for the use of mobile phones in the affected area must be complied with.
- Risk of fire or explosion. The I_{site} can generate sparks which may ignite flammable chemicals. Do not use the I_{site} at petrol stations or near fuels or other flammable chemicals.
- Risk of involuntary detonation of explosives. The radio waves generated by the I_{site} can cause the involuntary detonation of explosives by triggered detonators or similar devices. The same rules applied to radio transmitters must be complied with near explosive areas. This usually means that the I_{site} cannot be used in these areas.
- Risk of injury or material damage. In some special areas the radio waves generated by the I_{site} can lead to unforeseen risks. In these areas, comply with the rules and instructions applied to the use of radio transmitters, mobile phones and similar devices.

I_{site} PIN code request

Before starting the truck, the I_{site} demands a PIN code to be entered on the keypad. For details of this function, please refer to the PIN CODE ENTRY SYSTEM section of this manual.

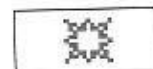

2.5.13 Shock sensor (Option)

This function detects and records any collisions to the truck when running. If the setting is enabled, the shock sensor icon is displayed when starting the truck.

If the detected shock exceeds the preset alarm value on front, back or lateral direction, the Shock Alarm icon and buzzer signal an alarm to the operator. A truck speed reduction may also occur if the Service Centre enabled this feature. Because only the administrator can cancel the buzzer sounds, the operator necessarily must report it to the administrator. The detected shock values, date and time are recorded on the multi-function display at the moment of the detection. If the PIN Code Entry System option is enabled, the PIN code is also recorded.

The strength of the shock generated on the truck depends on the objects the truck collided against. Not all of the collisions can be detected.

The shock generated in the usual operation depends on the road conditions, the loads, and the material handling operations.

All the detected records may not be necessarily based on a actual collision. Please investigate the records in consideration of the possibility of erroneous detections in the usual operation in addition to actual collisions.

2.5.14 Pre-operational check (Option)

This feature request the operator to answer some questions at his first daily login. Questions appear at display and it's required to answer Yes or No, with OK (11) or OUT (10) buttons, respectively. Critical questions are related to safety or truck inspection and require a minimum answer time of 30 seconds. If a critical question is wrongly replied, or no answers are provided within 5 minutes, the truck is locked and can only move at creep speed (1km/h). This setting is associated to operator profile and can be reset by an administrator. Different operator profiles can log in and operate the truck as usual.





3 OPERATION

3 OPERATION

3.1 OPERATING CONTROLS

The following are sample configurations.

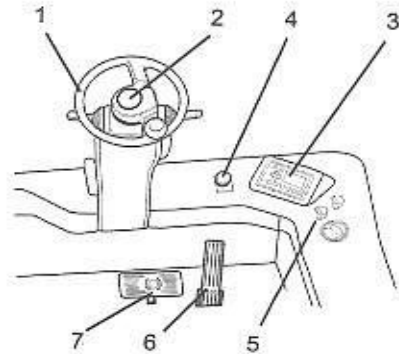

- (1) Steering wheel
- (2) Horn button
- (3) Dashboard
- (4) Emergency stop button
- (5) Heater switches (Option)
- (6) Accelerator
- (7) Service brake

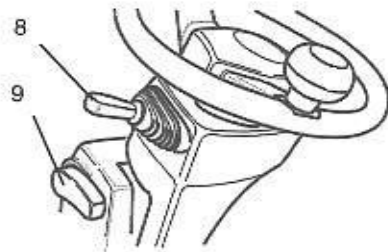

- (8) Direction control lever (only with single accelerator pedal)
- (9) Steering column tilt adjustment lever

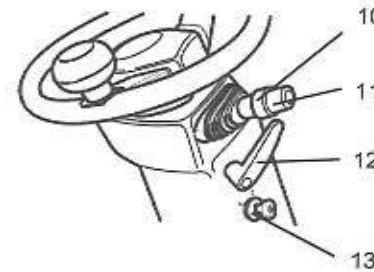

- (10) Lights switch (Option)
- (11) Turn signal switch (Option)
- (12) Telescopic steering column lever
- (13) Ignition key switch

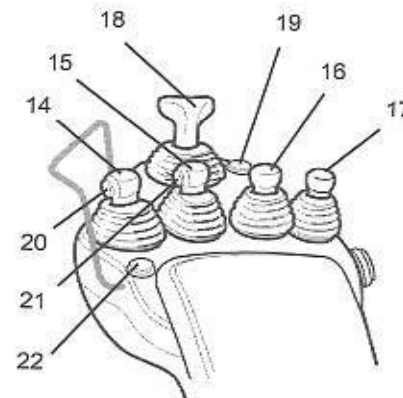

- (14) Lift lever
- (15) Tilt lever
- (16) Lever for attachments
- (17) Lever for attachments (Option)
- (18) Direction control lever
- (19) Height limiter switch
- (20) Load indicator switch / Automatic height control switch (Option)
- (21) Automatic fork leveling switch
- (22) Horn switch

3.2 BODY COMPONENTS

3.2.1 Operator's seat

Use of seat

⚠ WARNING

To avoid accidents, adjust the seat position before operating the truck. Never adjust your seating position while the truck is moving.



⚠ CAUTION

- The OPS seat switch prevents powered traveling and load handling operations when the operator is not seated in the seat. Be sure to remain seated in the seat while in operation. Do not operate the truck with any objects placed on the seat.
- Do not bypass the seat switch by any method other than sitting on the seat.

3.2.1.1 Seat type

ORS seat

You can adjust the forward/backward seat position and the reclining angle of this seat. Adjust the seat position so that you can depress all pedals fully with your back leaning against the backrest of the operator's seat.

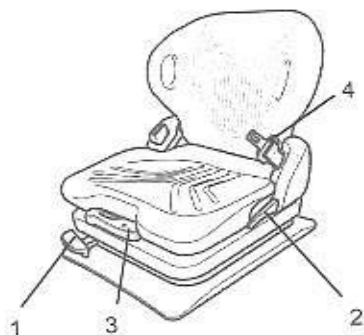

(1) Adjusting the operator's seat position

Lift the seat slide lever to adjust the seat back and forth.

Release the lever and the seat position is fixed.

Lightly shake the seat back and forth to make sure it is locked securely.

(2) Adjusting the reclining angle of the operator's seat

Pull the recliner adjustment lever to adjust the angle of the backrest.

Release the lever and the backrest position is fixed.

Lightly shake the seat back and forth to make sure it is locked securely.

(3) Adjusting the suspension seat weight

Fold out the weight adjustment lever completely.

Lower the lever for lighter body weight; raise the lever for heavier body weight.

When you have set the weight, bring the lever back to the starting position.



NOTICE

- When the minimum/maximum has been reached, you can notice an empty movement in the handle.
- When you have set the weight, always fold the lever completely into the locking.

(4) Seat belt

Seat pocket

An Operator's Manual and Manual for Safe Operation are located behind the seat. If your truck does not have a manual, ask the Service Centre for a copy.

Press the retainer and pull down the cover to open the pocket.

NOTICE

Always make certain the pocket is securely closed.

MSG seat

You can adjust the forward/backward seat position and the reclining angle of this seat. You can adjust the lumbar support and the headrest height as well. Adjust the seat position so that you can depress all pedals fully with your back leaning against the backrest of the operator's seat.



3 OPERATION



(1) **Adjusting the operator's seat position**

Lift the seat slide lever to adjust the seat back and forth.

Release the lever and the seat position is fixed.

Lightly shake the seat back and forth to make sure it is locked securely.

(2) **Adjusting the reclining angle of the operator's seat**

Pull the recliner adjustment lever to adjust the angle of the backrest.

Release the lever and the backrest position is fixed.

Lightly shake the seat back and forth to make sure it is locked securely.

(3) **Adjusting the suspension seat weight**

Lower the lever for heavier body weight; raise the lever for lighter body weight.

When you have set the weight, bring the lever back to the starting position.

(4) **Seat belt**

(5) **Adjusting the lumbar support**

To adjust the lumbar support, turn the lumbar adjustment knob clockwise to increase the supporting power or counter-clockwise to decrease it.

(6) **Adjusting the headrest position**

- The headrest height can be adjusted by it sliding up and down.



Seat belt

⚠ WARNING

- Always wear your seat belt when operating the truck. The truck can tip over if operated improperly. To protect operators from the risk of serious injury or death in the event of a tip over, it is best to be held securely in the seat. The seat and seat belt will help to keep you safely within the truck and operator's compartment. In the event of a tip over, don't jump, grip the steering wheel, brace your feet, lean away from the direction of tip over, and stay with the truck.
- Before fastening the seat belt, check its bracket and belt itself for any abnormal condition.
- Do not fasten the seat belt if it is twisted.
- Wear the seat belt at the lowest possible part of the hip bone tightly.
- Do not adjust the seat belt so it is loose on the body by adding slack purposely with a clip or the like.
- If the seat belt is exposed to a strong impact in an accident, the belt may be damaged or torn. As such seat belt can not perform its intended function, replace it.
- If the seat belt is damaged, do not use the forklift until it is repaired.

Fastening the seat belt

1. To fasten your seat belt, pull it out of the retractor and insert the tongue into the buckle.
2. You will hear a click when the tongue locks into the buckle. Pull on the belt to make sure the buckle is securely latched. The seat belt length will be automatically adjusted to your size.

Disconnecting the seat belt

To release the lock, press the red button at the mouth of the buckle. The belt will be automatically retracted into the retractor.



NOTICE

If the seat belt is locked and cannot be pulled out any further, tug sharply on the belt just once, allow it to slacken, then pull it slowly.

Swivel seat (Option)

The swivel seat is useful when traveling in the reverse direction over long distances or when getting off the truck.

1. Pull the lock release lever upward to release the lock.
2. Rotate the seat to the right for traveling in reverse; rotate the seat to the left for getting off the truck.

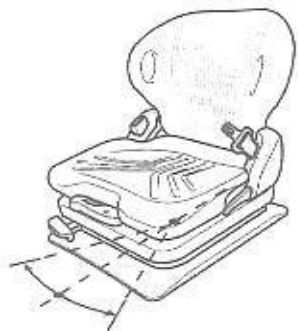

NOTICE

Release the lock release lever once the seat starts to rotate.

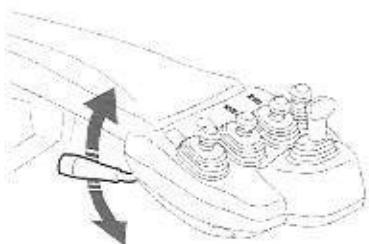

⚠ CAUTION

- To prevent accidents, do not rotate the seat while operating the truck.
- While rotating the seat, be careful not to put your hand etc. in range of rotation.
- While rotating the seat in cab models, be careful not to get your hand caught between the seat and cab.
- While operating the truck forward or in reverse, make sure that the seat is securely locked.
- The seat will not be locked into place when rotating to the left.
- After the operations, return the seat to normal position and confirm that the seat is locked in place.

3.2.2 Armrest

Armrest position adjustment

Before starting the truck, adjust the armrest to set the optimal driving position.

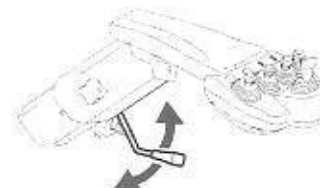
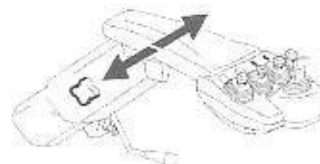
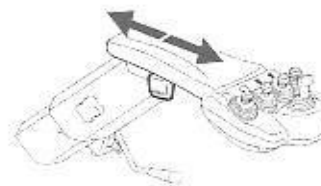

Adjusting the forward-backward position

1. Pull up and loosen the forward-backward position adjustment knob.
2. Adjust the armrest forward-backward position.
3. Then press the knob, securing the armrest position in place.

Adjusting the height position

1. Turn the height adjustment knob counter-clockwise to release the lock.
2. Then, move the armrest up-and-down to place it to a desired position.
3. Turn knob clockwise to lock.

Tilt adjustment

1. Pull up and loosen the lever for turning and securing the armrest.
2. Adjust the tilt of the armrest.
3. Then push the lever down, securing the armrest position in place. This lever is also used in order to turn the armrest when you open and close the battery hood.

⚠ CAUTION

- Do not adjust the armrest position while the truck is moving.
- After the adjustment of the armrest position, confirm that the knobs and the lever have been secured in place. A loose knob or lever may cause an accident.
- To operate the truck safely, lock the armrest securely. Before operating the truck, always confirm that the lever for turning and securing the armrest is locked.

Fully adjustable armrest (Option)

Before starting the truck, adjust the armrest to set the optimal driving position.



3 OPERATION

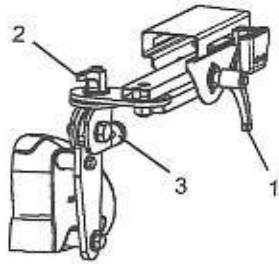

Adjusting the forward-backward position

1. Loosen the forward-backward position adjustment knob.(1)
2. Adjust the armrest forward-backward position.
3. Then tighten the knob, securing the armrest position in place.

Adjusting the left-right position

1. Loosen the left-right position adjustment knob.(2)
2. Adjust the armrest left-right position.
3. Then tighten the knob, securing the armrest position in place.

Tilt adjustment

1. Loosen the knob for turning and securing the armrest.(3)
2. Adjust the tilt of the armrest.
3. Then tighten the knob, securing the armrest position in place. This knob is also used in order to turn the armrest when you open and close the battery hood.

3.2.3 Battery hood

Battery side hood

Opening

To open the battery side hood, unlock it by pulling the handgrip, then lift it by the handgrip.

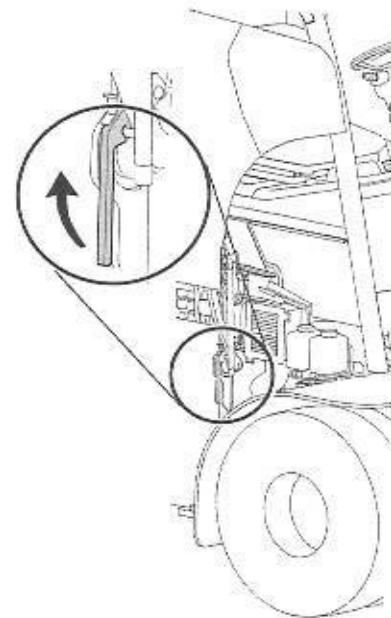
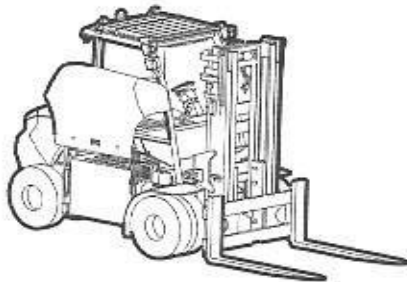

Closing

1. Keep the safety catch pulled.
2. Press down on the side hood until you hear a clicking sound.

⚠ WARNING

Make certain that the battery is held securely in place before using the truck.

NOTICE

When closing the hood, make certain that the battery cables and all components are correctly positioned.

3.2.4 Overhead guard

When properly maintained, the overhead guard will help protect the operator from falling objects.

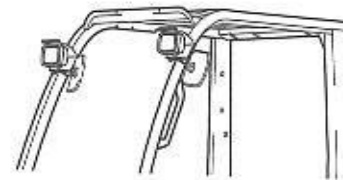

3.2.5 Lights

- (1) Headlights / Front combination lights
- (2) Additional front headlights
- (3) Additional headlights on top of rear overhead guard
- (4) Additional thin light on mast
- (5) Rear combination lights
- (6) Rear working lights
- (7) Blue warning light
- (8) Yellow beacon lamp - upper overhead guard
- (9) Yellow beacon lamp - lower overhead guard

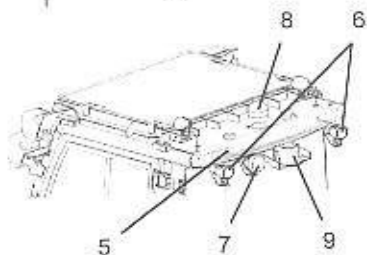
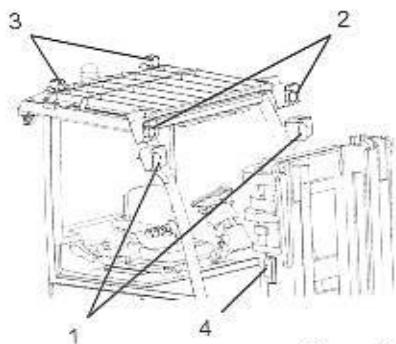

3.2.6 Cabin

Half cab

- (1) Windscreen
- (2) Roof
- (3) Rear window

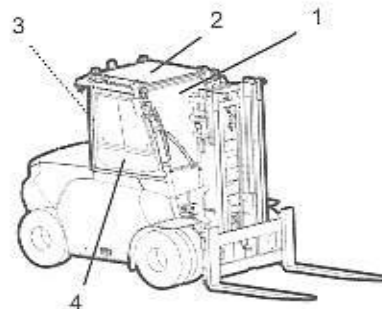
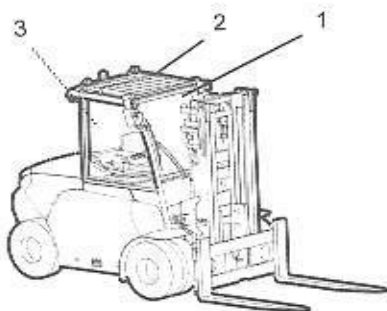

Full cab

- (1) Windscreen
- (2) Roof
- (3) Rear window
- (4) Door (right) / Side window (left)

Doors

Left door can be locked by the key. The door key is not the same as an ignition key switch.

Outside the truck

- (1) Grasp the door handle and pull toward you to release the lock and open the door.
- (2) When closing the door, press the door handle until the door lock catches.

Inside the truck

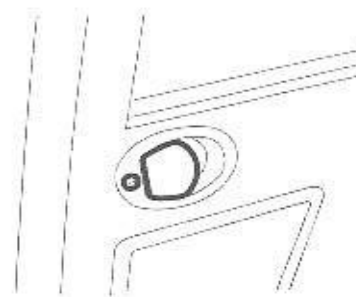



3 OPERATION

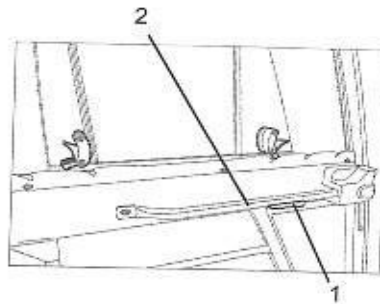

- (1) Grasp the unlock lever (1) to release the door.
- (2) Press the door pull handle (2) to open the door.

CAUTION

- When opening doors, be aware of pedestrians or other trucks.
- Always close the door by pulling the door pull handle. Before operating the truck, confirm that the doors are securely closed.

Side door window

The side windows can slide in the right-left direction. Grasping the knobs (1) will release the locks. Slide the windows until they lock into the desired positions (2).

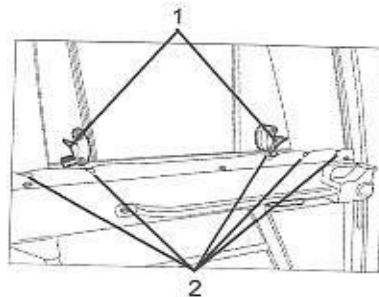

Audio

The radio player and speakers are fitted to the roof.

Please refer to the manual provided by the manufacturer.

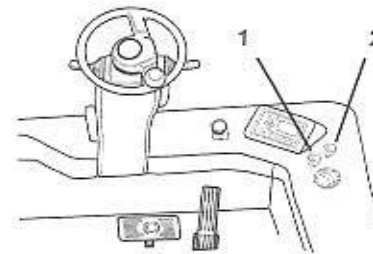
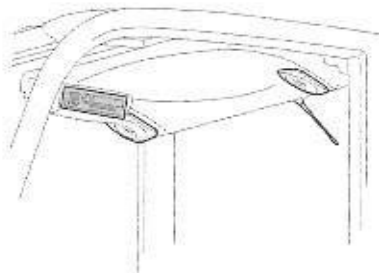

Heater and defroster

Heater

The heater is attached to the right side of the instrument panel.

Turn the heater switch (1) clockwise to operate the heater in three air volumes. The switch has four positions: OFF, low speed, medium speed, high speed. The air outlet can be opened or closed and the entry of debris and dust into the heater unit can be prevented.

Turn the heater switch (2) clockwise to adjust the temperature of the heater to your preference. Three positions are available: low, medium and high temperature.

Defroster

The defroster is attached at the base of the front windshield. It will allow you to quickly defog the front windshield.

Close the air outlet of the heater to turn on the defroster.

Use the heater switches to switch on and off the defroster.

NOTICE

Using the heater for extended periods of time will cause the air inside the cabin to become stale and the glass to fog, so take care to open windows and ventilate inside the cabin.

3.2.7 Safety gates (Option)

Increase the operator's safety in case of tip over. May be fitted with a sensor that inhibits the truck movement when the gate lock is open.

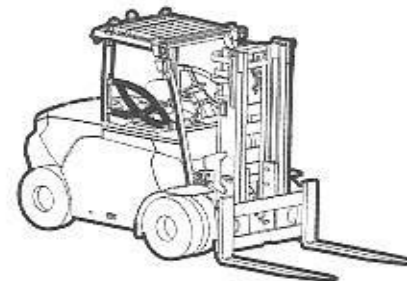



3.2.8 Load handling system

Mast

The mast is mounted to the front of the truck. Hydraulic tilting cylinders are used to tilt the mast forward and backward. Hydraulic lifting cylinders and chains are used to raise the carriage and attachments.

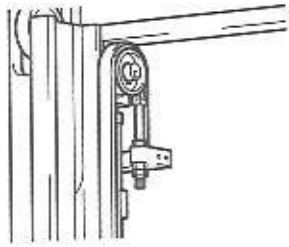

Safety end stops prevent the accidental escape of the fork carriage from the top of the mast. Pictures show some examples.

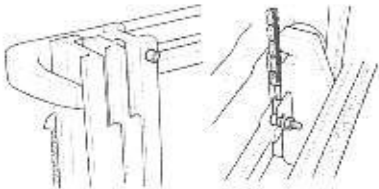

Mast collars are fitted on every lifting cylinder. Pictures show some examples.

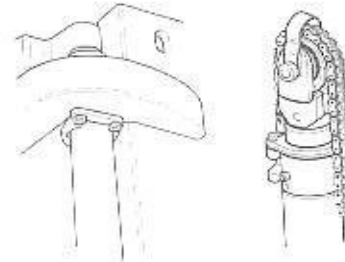
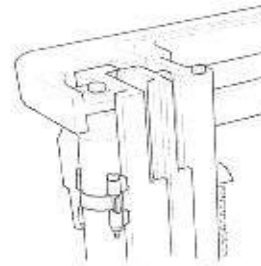

Chain anchoring bolts are locked by cotter pins (as shown in the picture) or seeger rings.

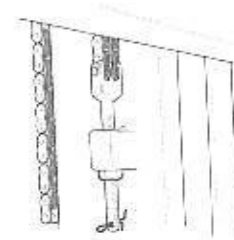

⚠ WARNING

- The mast is designed for lifting loads not people. Do not use your forklift in place of an elevating work platform.
- Never place any part of your body in any part of the mast, the carriage or attachment.

Forks

Adjust the forks in the position most appropriate for the load by unlocking the fork stopper.

1. Pull up and rotate the fork stoppers.
2. Adjust the fork position.
3. After the adjustment, make sure to set the stopper to locked position to keep the forks in place.

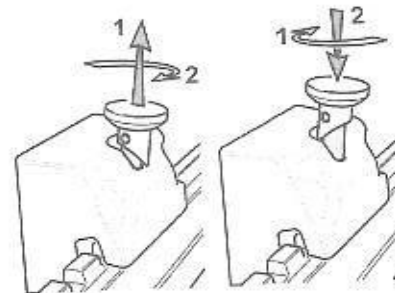



⚠ WARNING

- Forks are heavy. Caution is required when sliding a fork on the carriage as it may become difficult to slide even if force is applied to the fork when sliding it on the carriage.
- When adjusting the forks, make sure that the weight of the load is centered on the truck.
- Make sure the forks are securely locked before carrying a load.

Carriage end stops prevent removal of the forks from the side of the carriage. Pictures show some examples.

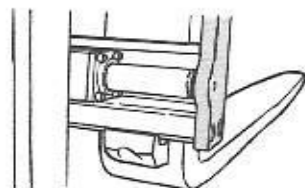
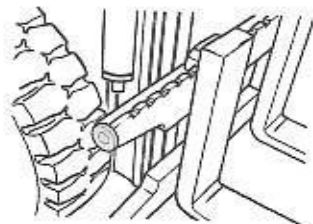

Load backrest extension (Option)

When properly maintained, the load backrest extension will help stabilize the load and prevent parts of a load from falling back into the operator's compartment.

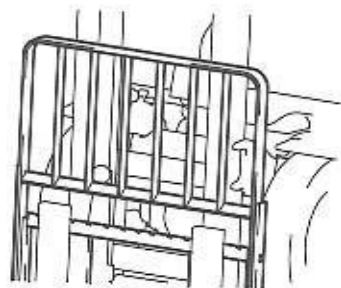

3.3 SWITCHES AND LEVERS

3.3.1 Mini levers

Direction control lever

Shift lever to change the travel direction between forward and reverse.

Forward travel: Push the lever forward

Reverse travel: Pull the lever backward

The neutral position is halfway between the forward and reverse position.

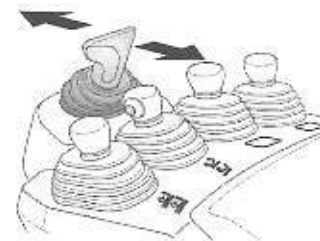

⚠ CAUTION

Perform travel direction change with care when carrying a load.

NOTICE

If the OPS is activated, release the accelerator pedal, return all levers to their neutral positions and return to the normal seated position.

Lift lever

Used to lift or lower the forks. The lever tilt controls the speed.

Lift: Pull the lever backward

Lower: Push the lever forward



Tilt lever

Used to tilt the mast forward or backward. The lever tilt controls the speed.

Forward: Push the lever forward

Backward: Pull the lever backward

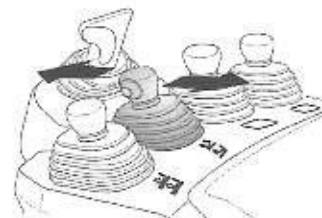



Attachment lever (Option)

Used to control any fitted attachments. A label is attached near the lever, graphically showing the attachment function related to the lever movement. Please refer to the WARNING LABELS section of this manual.

Function shown in the upper portion of the label: push the lever forward

Function shown in the lower portion of the label: pull the lever backward

NOTICE

If the OPS is activated, release the accelerator pedal, return all levers to their neutral positions and return to the normal seated position.

Sideshift lever (Option)

Used to shift the forks horizontally. The lever tilt controls the speed.

Forks right: Shift the lever to the right

Forks left: Shift the lever to the left



3rd-5th way control (Option)

Operate the attachment lever to activate the 3rd way functions.

Press the switch and simultaneously operate the attachment lever to activate the 5th way functions.

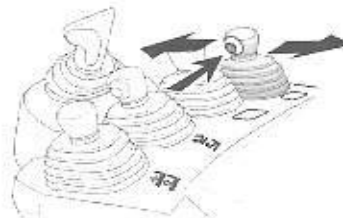

Clamp attachment control (Option)

Used to open and close the clamp attachment. The safety switch prevents unintentional activation of the clamp.

Open: keep the clamp safety switch pressed and push the lever forward

Close: keep the clamp safety switch pressed and push the lever backward



Automatic fork leveling switch

Press the button and tilt the mast forward. The forks stop in the horizontal position (with the mast in the vertical position). To tilt the mast further forward, return the lever to neutral before activating it again.

Lifting height	Without load	With load
High	The tilting stops with the forks levelled (mast vertical)	Not tilting forward
Reduced	The tilting stops with the forks levelled (mast vertical)	The tilting stops with the forks levelled (mast vertical) or up to 1° to the rear, depending on the load

⚠ DANGER

For details of this function, please refer to the SAS FUNCTION section of this manual.



Horn switch

Press the horn switch (1) to sound the horn.

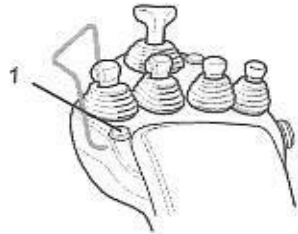

NOTICE

- Do not operate the horn continuously more than 3 minutes. This may result in a malfunction.
- Do not operate the horn frequently more than necessary. This may result in a malfunction.

The horn will sound even when the truck is turned off.

Load indicator switch (Option)

Pressing the load indicator switch (1) for few seconds will display the weight of the load.

For further information on Load Indicator, please refer to the DISPLAY INDICATORS section of this manual.

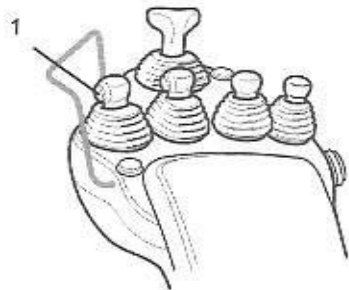

NOTICE

If the truck is fitted with both the Height Selector and the Load Indicator, the load indicator switch has two functions: automatic height control selector and load indicator switch. A short click on the Load Indicator switch will, as usual, enable the Automatic Height Control. Longer pressure enables the Load Indicator, if the lifting lever is not enabled in neutral. The Load Indicator is not enabled while the mast is lifted to the height memorized by the Automatic Height Control.

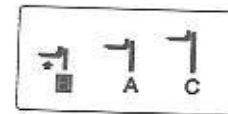
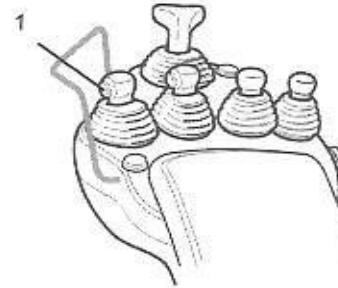

Automatic height control (Option)

This function is part of the Height Selector option.

This function is used to memorize up to three preferential height positions. A short click of the load indicator switch (1) with the lever in neutral will display the service screen. The order of the height memories is always displayed on the screen in low order.

The click counter and selected position memorization are indicated as follows, whatever the effective position of the forks at that time.

- (1) Lower height
- (2) Intermediate height
- (3) Upper height
- (4) No height selected (counter reset)

The selected height and service screen are cleared if there are no clicks or lift operations within 10 seconds or the lift lever is moved downwards or to neutral.

Moving the lift lever upwards within 10 seconds will stop the forks automatically at the selected height, when this height is reached the buzzer will sound.

- (1) Lower height: single short buzzer sound (pi..pi..pi..)
- (2) Intermediate height: two short buzzer sounds (pipi..pipi..pipi..)
- (3) Upper height: three short buzzer sounds (pipipi..pipipi..pipipi..)

When a limitation function of the material handling or the OPS function activates, all the function of the Height Selector (including the screen) are canceled. The movement of the mast is halted.

When selecting a favorite height position lower than the current height, this function prevents forks from lifting. In this case, the buzzer sounds for a second, and the screen informs the operator of the invalid operation.



NOTICE

If the truck is fitted with both the Height Selector and the Load Indicator, the load indicator switch has two functions: automatic height control selector and load indicator switch. A short click on the load indicator switch will, as usual, enable the Automatic Height Control. Longer pressure enables the Load Indicator, if the lifting lever is in neutral. The Load Indicator is not enabled while the mast is lifted to the height memorized by the automatic height control.

Height limiter switch (Option)

This function is part of the Height Selector option.

This function is used to memorize a fork limit height position. When the required position is memorized and the height limiter switch (2) is enabled the function is active and the height limiter indicator is shown on the display.

When the lift lever is operated upward and the forks reach the memorized position, the forks automatically stop there, the indicator flashes and the buzzer sounds. The forks can be lifted above the memorized position by releasing the height limiter switch. If the lift lever is operated upward at the height where forks have already exceeded the memorized position, the forks never rise up and the buzzer also sounds for a second.

NOTICE

For details of this function, please refer to the OPERATOR SETTINGS MENU section of this manual.

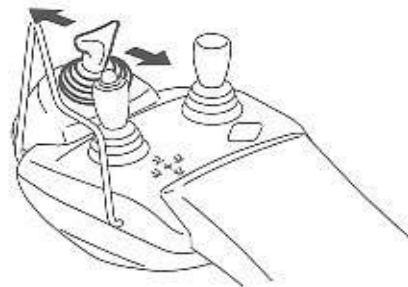

3.3.2 Multifunction levers

Direction control lever

Shift lever to change the travel direction between forward and reverse.

Forward travel: Push the lever forward

Reverse travel: Pull the lever backward

The neutral position is halfway between the forward and reverse position.

⚠ CAUTION

Perform travel direction change with care when carrying a load.

NOTICE

If the OPS is activated, release the accelerator pedal, return all levers to their neutral positions and return to the normal seated position.

Lift and tilt lever

Used to lift or lower the forks; used to tilt the mast forward or backward. Tilting the lever diagonally will control two movements at the same time. The lever tilt controls the speed.

Lift: Shift the lever to the right

Lower: Shift the lever to the left

Forward: Push the lever forward

Backward: Pull the lever

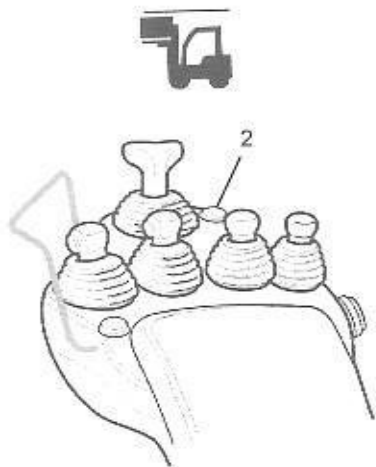



3 OPERATION

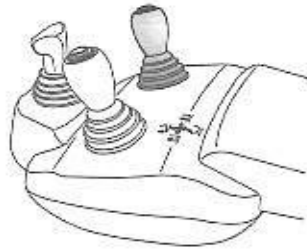

Attachment lever (Option)

Used to control any fitted attachments. A label is attached near the lever, graphically showing the attachment function related to the lever movement. Please refer to the WARNING LABELS section of this manual.

Function shown in the upper portion of the label: push the lever forward

Function shown in the lower portion of the label: pull the lever backward

Function shown in the right portion of the label: shift the lever to the right

Function shown in the left portion of the label: shift the lever to the left

NOTICE

If the OPS is activated, release the accelerator pedal, return all levers to their neutral positions and return to the normal seated position.

Sideshift lever (Option)

Used to shift the forks horizontally. The lever tilt controls the speed.

Forks right: Shift the lever to the right

Forks left: Shift the lever to the left

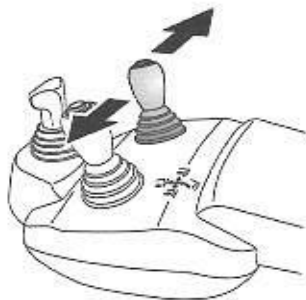

4th-5th way control

Operate the attachment lever to activate the 4th way functions.

Press the switch and simultaneously operate the attachment lever to activate the 5th way functions.



Clamp attachment control

Used to open and close the clamp attachment. The safety switch prevents unintentional activation of the clamp.

Open: Keep the clamp safety switch pressed and push the lever forward

Close: Keep the clamp safety switch pressed and push the lever backward

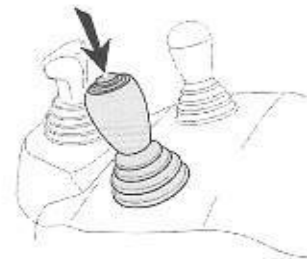

Automatic fork leveling switch

Press the button and tilt the mast forward. The forks stop in the horizontal position (with the mast in the vertical position). To tilt the mast further forward, return the lever to neutral before activating it again.

	Lifting height	Without load	With load
High		The tilting stops with the forks levelled (mast vertical)	Not tilting forward



Lifting height	Without load	With load
Reduced	The tilting stops with the forks levelled (most vertical)	The tilting stops with the forks levelled (most vertical) or up to 1° to the rear, depending on the load

⚠ DANGER

For details of this function, please refer to the SAS FUNCTION section of this manual.

Horn switch

Press the horn switch (1) to sound the horn.

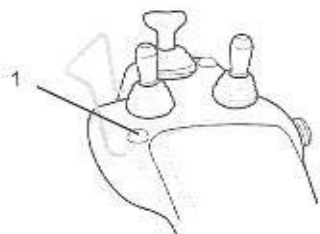

NOTICE

- Do not operate the horn continuously more than 3 minutes. This may result in a malfunction.
- Do not operate the horn frequently more than necessary. This may result in a malfunction.

The horn will sound even when the key switch is turned off.

Load indicator switch (Option)

Pressing the load indicator switch (1) for few seconds will display the weight of the load.

For further information on Load Indicator, please refer to the DISPLAY INDICATORS section of this manual.

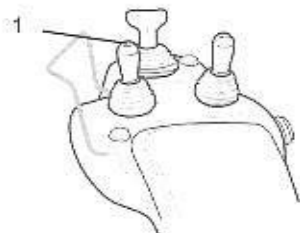

NOTICE

If the truck is fitted with both the Height Selector and the Load Indicator, the load indicator switch has two functions: automatic height control selector and load indicator switch. A short click on the Load Indicator switch will, as usual, enable the Automatic Height Control. Longer pressure enables the Load Indicator, if the lifting lever is in neutral. The Load Indicator is not enabled while the mast is lifted to the height memorized by the Automatic Height Control.

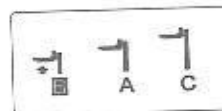
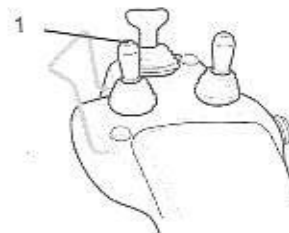

Automatic height control (Option)

This function is part of the Height Selector option.

This function is used to memorize up to three preferential height positions. A short click of the load indicator switch (1) with the lever in neutral will display the service screen. The order of the height memories is always displayed on the screen in low order.

The click counter and selected position memorization are indicated as follows, whatever the effective position of the forks at that time.

- (1) Lower height
- (2) Intermediate height
- (3) Upper height
- (4) No height selected (counter reset)

The selected height and service screen are cleared if there are no clicks or lift operations within 10 seconds or the lift lever is moved downwards or to neutral.

Moving the lift lever upwards within 10 seconds will stop the forks automatically at the selected height, when this height is reached the buzzer will sound.

- (1) Lower height: single short buzzer sound (pi..pi..pi..)
- (2) Intermediate height: two short buzzer sounds (pipi..pipi..pipi..)
- (3) Upper height: three short buzzer sounds (pipipi..pipipi..pipipi..)

When a limitation function of the material handling or the OPS function activates, all the function of the Height Selector (including the screen) are canceled. The movement of the mast is halted.

When selecting a favorite height position lower than the current height, this function prevents forks from lifting. In this case, the buzzer sounds for a second, and the screen informs the operator of the invalid operation.



3 OPERATION

On models with multifunction levers, it is not possible to select a required height during tilting operations, as the automatic levelling function is active.

NOTICE

If the truck is fitted with both the Height Selector and the Load Indicator, the load indicator switch has two functions: automatic height control selector and load indicator switch. A short click on the Load Indicator switch will, as usual, enable the Automatic Height Control. Longer pressure enables the Load Indicator, if the lifting lever is in neutral. The Load Indicator is not enabled while the mast is lifted to the height memorized by the Automatic Height Control.

Height limiter switch (Option)

This function is part of the Height Selector option.

This function is used to memorize a fork limit height position. When the required position is memorized and the height limiter switch (2) is enabled the function is active and the height limiter indicator is shown on the display.

When the lift lever is operated upward and the forks reach the memorized position, the forks automatically stop there, the indicator flashes and the buzzer sounds. The forks can be lifted above the memorized position by releasing the height limiter switch. If the lift lever is operated upward at the height where forks have already exceeded the memorized position, the forks never rise up and the buzzer also sounds for a second.

NOTICE

For setting this function, please refer to the OPERATOR SETTINGS MENU section of this manual.

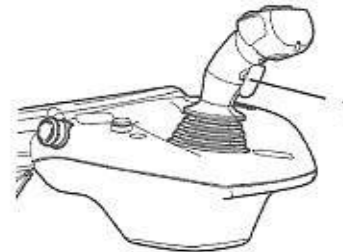

3.3.3 Multifunction joystick (Option)

OPS switch

Keep the OPS switch (1) pressed while performing load handling operations.

Direction control lever

Shift lever to change the travel direction between forward and reverse.

Forward travel: Push the lever forward

Reverse travel: Pull the lever backward

The neutral position is halfway between the forward and reverse position.



⚠ CAUTION

Perform travel direction change with care when carrying a load.

NOTICE

If the OPS is activated, release the accelerator pedal, return all levers to their neutral positions and return to the normal seated position.



Lift and tilt functions

Used to lift or lower the forks; used to tilt the mast forward or backward. Tilting the lever diagonally will control two movements at the same time. The lever tilt controls the speed.

Lift: Pull the lever

Lower: Push the lever forward

Forward: Shift the lever to the right

Backward: Shift the lever to the left

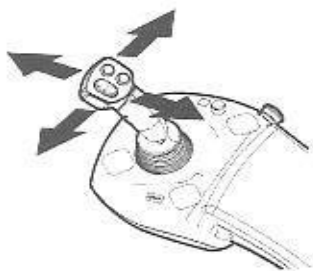

Attachment function (Option)

Used to control any fitted attachments by switches (1) and (2).

NOTICE

If the OPS is activated, release the accelerator pedal, return all levers to their neutral positions and return to the normal seated position.

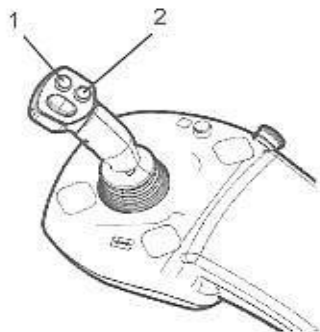

Sideshift function (Option)

Used to shift the forks horizontally. The joystick tilt controls the speed.

Forks right: Keep the attachment switch pressed and shift the lever to the right

Forks left: Keep the attachment switch pressed and shift the lever to the left



4th way control (Option)

Press the switch and simultaneously operate the attachment lever to activate the 4th way functions.

A label is attached near the lever, graphically showing the attachment function related to the lever movement. Please refer to the WARNING LABELS section of this manual.

Function shown in the upper portion of the label: push the lever forward

Function shown in the lower portion of the label: pull the lever backward

5th way / Clamp attachment control (Option)

Used to open and close the clamp attachment. The safety switch prevents unintentional activation of the clamp.

Open: Keep the clamp safety switch pressed and shift the lever to the left

Close: Keep the clamp safety switch pressed and shift the lever to the right



Automatic fork leveling switch

Press the switch (1) and tilt the mast forward. The forks stop in the horizontal position (with the mast in the vertical position). To tilt the mast further forward, return the lever to neutral before activating it again.

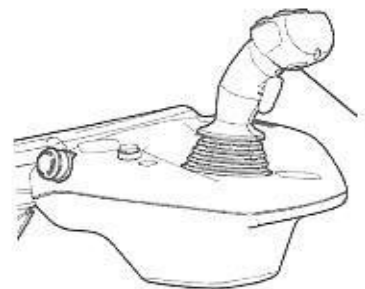



3 OPERATION

Lifting height	Without load	With load
High	The tilting stops with the forks levelled (mast vertical)	Not tilting forward
Reduced	The tilting stops with the forks levelled (mast vertical)	The tilting stops with the forks levelled (mast vertical) or up to 1° to the rear, depending on the load

⚠ DANGER

For details of this function, please refer to the SAS FUNCTION section of this manual.

Load indicator switch (Option)

Pressing the load indicator switch (1) for few seconds will display the weight of the load.

For further information on Load Indicator, please refer to the DISPLAY INDICATORS section of this manual.

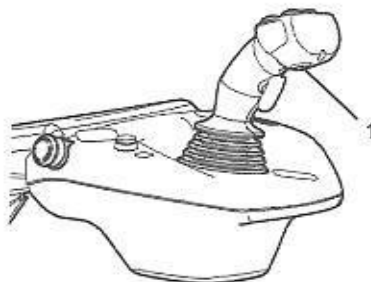

NOTICE

If the truck is fitted with both the Height Selector and the Load Indicator, the load indicator switch has two functions: automatic height control selector and load indicator switch. A short click on the Load Indicator switch will, as usual, enable the Automatic Height Control. Longer pressure enables the Load Indicator, if the lifting lever is in neutral. The Load Indicator is not enabled while the mast is lifted to the height memorized by the Automatic Height Control.

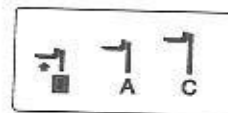
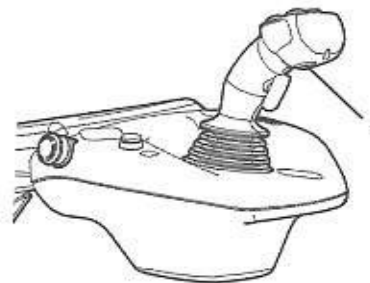

Automatic height control (Option)

This function is part of the Height Selector option.

This function is used to memorize up to three preferential height positions. A short click of the load indicator switch (1) with the lever in neutral will display the service screen. The order of the height memories is always displayed on the screen in low order.

The click counter and selected position memorization are indicated as follows, whatever the effective position of the forks at that time.

- (1) Lower height
- (2) Intermediate height
- (3) Upper height
- (4) No height selected (counter reset)

The selected height and service screen are cleared if there are no clicks or lift operations within 10 seconds or the lift lever is moved downwards or to neutral.

Moving the lift lever upwards within 10 seconds will stop the forks automatically at the selected height, when this height is reached the buzzer will sound.

- (1) Lower height: single short buzzer sound (pi..pi..pi..)
- (2) Intermediate height: two short buzzer sounds (pipi..pipi..pipi..)
- (3) Upper height: three short buzzer sounds (pipipi..pipipi..pipipi..)

When a limitation function of the material handling or the OPS function activates, all the function of the Height Selector (including the screen) are canceled. The movement of the mast is halted.

When selecting a favorite height position lower than the current height, this function prevents forks from lifting. In this case, the buzzer sounds for a second, and the screen informs the operator of the invalid operation.



On models with multifunction joystick, it is not possible to select a required height during tilting operations, as the automatic levelling function is active.

NOTICE

If the truck is fitted with both the Height Selector and the Load Indicator, the load indicator switch has two functions: automatic height control selector and load indicator switch. A short click on the load indicator switch will, as usual, enable the Automatic Height Control. Longer pressure enables the Load Indicator, if the joystick is in neutral; if the joystick is activated forward or backward, longer pressure enables the Automatic Fork Leveling. The Load Indicator is not enabled while the mast is lifted to the height memorized by the automatic height control.

Height limiter switch (Option)

This function is part of the Height Selector option.

This function is used to memorize a fork limit height position. When the required position is memorized and the height limiter switch (2) is enabled the function is active and the height limiter indicator is shown on the display.

When the lift lever is operated upward and the forks reach the memorized position, the forks automatically stop there, the indicator flashes and the buzzer sounds. The forks can be lifted above the memorized position by releasing the height limiter switch. If the lift lever is operated upward at the height where forks have already exceeded the memorized position, the forks never rise up and the buzzer also sounds for a second.

NOTICE

For setting this function, please refer to the OPERATOR SETTINGS MENU section of this manual.



3.3.4 Steering column

Steering column tilt adjustment lever

The steering wheel position can be adjusted back and forth by the following procedure.

- (1) Pull the tilt adjustment lever up.
- (2) Adjust the steering wheel to the desired position.
- (3) Lock the steering wheel position by pushing down the lever.
- (4) After adjustment, try to move the steering wheel back and forth to make sure it is locked.

3

⚠ WARNING

- Do not adjust the steering wheel position while the truck is moving. It may lead to incorrect operation and cause an unexpected accident.
- After adjustment, lightly shake the steering wheel back and forth to make sure it is locked securely. Otherwise, the steering wheel could move during operation, causing an accident.

Telescopic steering column (Option)

1. Pull the height adjustment lever up.
2. Hold the steering wheel with both hands, and adjust the height.
3. Hold the height adjustment lever down at the desired position, and lock the steering wheel securely. The steering wheel will be locked.
4. After adjustment, try to move the steering wheel back and forth to make sure it is locked.

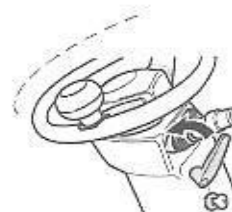



3 OPERATION



Ignition key switch

Insert the key with the teeth facing upward.

OFF: Truck stop. Insert and withdraw the key in this position.

ON: Truck ready to be started. Located one position clockwise from the OFF position.

⚠ WARNING

- Do not turn the key switch to ON while pressing the accelerator pedal at the same time.
- When you turn the key switch to ON, be sure that you are in the normal seated position with the seat belt fastened and the parking brake applied.
- If the OPS indicator is displayed, return the direction control and load handling control levers to the neutral positions and sit in the seat. Confirm that the OPS indicator goes off.
- Before switching off the truck, apply the parking brake.
- When the key switch is turned to OFF, the forks will not lower even if the lift lever is operated. The forks can be lowered when the operator is seated in the operator's seat and key switch is turned on (Key-lift interlock)
- Remove the key switch when the truck is not in use.

Turn signal switch (Option)

Shift lever to light the turn signals.

Left turn: Push the lever forward

Right turn: Pull the lever back

The signal switch operates regardless of the position of the ignition key switch.

The turn signal lever returns automatically to the original position after making a direction change.

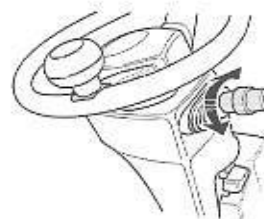
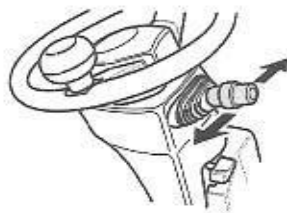

Lights switch (Option)

This switch has two positions.

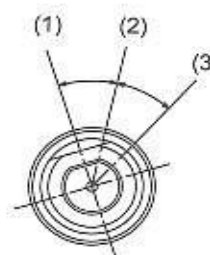

(1) OFF

(2) Position 1

(3) Position 2

With the switch at each position, the lights come on as shown below.

Light name	Position 1	Position 2
Headlights; Working lights	OFF	ON
Tail lights	ON	ON

Direction control lever (Option)

(Only with single accelerator pedal)

Shift lever to change the travel direction between forward and reverse.

Forward travel: Push the lever forward

Reverse travel: Pull the lever backward

The neutral position is halfway between the forward and reverse position.

⚠ CAUTION

Perform travel direction change with care when carrying a load.

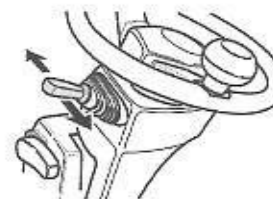



NOTICE

If the OPS is activated, release the accelerator pedal, return all levers to their neutral positions and return to the normal seated position.

Horn button

Press the button in the center of the steering wheel to sound the horn. The horn will sound even when the key switch is turned off.

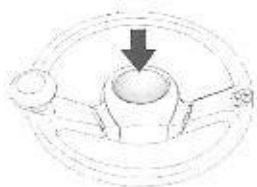

NOTICE

- Do not operate the horn continuously more than 3 minutes. This may result in a malfunction.
- Do not operate the horn more frequently than necessary. This may result in a malfunction.

3.3.5 Pedals

Accelerator pedal precautions

⚠ CAUTION

To avoid an unintended start of the truck, do not depress the accelerator pedal suddenly. Particularly when loaded or when stacking, the load may fall or collapse due to a sudden start. Always depress the accelerator pedal slowly.

NOTICE

If the OPS is activated, release the accelerator pedal, return all levers to their neutral positions and return to the normal seated position.

Brake pedal precautions

⚠ CAUTION

- Avoid sudden stop. Sudden stop will make the truck unstable and it may cause the truck to tip-over.
- The brake feeling differs between loaded and unloaded truck. Adjust the amount the brake pedal is depressed according to the loading state.
- Apply the brake with great care when transporting a load.
- Always release the accelerator pedal before applying the brakes.
- Slow down before setting the direction and travel change.
- If the OPS indicator is displayed on the screen, return to the seat and release the accelerator pedal. Make certain that the OPS indicator is off.

3

Single accelerator pedal

The travel speed is adjusted by the amount the accelerator pedal is depressed.

Travel: Depress the accelerator pedal (1)

Brake: Depress the brake pedal (2)

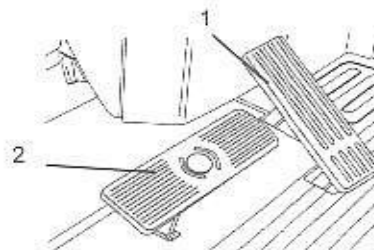



3 OPERATION

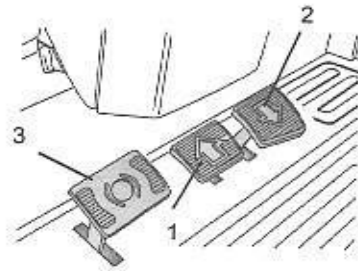

Double accelerator pedal (Option)

The travel speed is adjusted by the amount the accelerator pedal is depressed. The accelerator pedal also selects the travel direction.

Forward travel: Depress the left accelerator pedal (1)

Reverse travel: Depress the right accelerator pedal (2)

Brake: Depress the brake pedal (3)

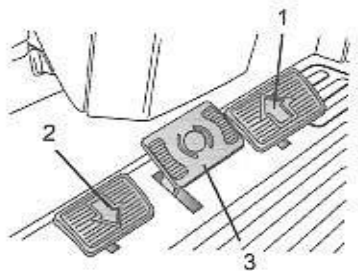

Balanced pedal (Option)

The travel speed is adjusted by the amount the accelerator pedal is depressed. The accelerator pedal also selects the travel direction.

Forward travel: Depress the right accelerator pedal (1)

Reverse travel: Depress the left accelerator pedal (2)

Brake: Depress the brake pedal (3)

3.3.6 Parking brake

Use of parking brake

⚠ WARNING

- Before applying the parking brake, depress the brake pedal and always confirm that the truck has come to a stop.
- Do not park the truck on a slope. Always park on level ground with forks flat on the floor so that no one will run into them. If



parking on a slope is unavoidable, place blocks behind the wheel to prevent the forklift from rolling.

- To park the truck safely, be certain to follow the parking procedure described in the Manual for Safe Operation.

3.3.7 Rear assist grip with horn button (Option)

The horn button in the rear assist grip can be easily turned on when back running.

3.4 INSTRUMENTS PANEL

3.4.1 Dashboard

Dashboard

Buttons:

- (0) Beacon lamp (Option)
- (1) Hazard warning lights (Option)
- (2) Rear working lights (Option)
- (3) Front windscreen wiper (Option)
- (4) Rear windscreen wiper (Option)
- (5) Heated rear window (Option)

- (6) Hour meter
- (7) Parking brake
- (8) Low speed
- (9) Power select
- (10) OUT button
- (11) OK button

Other:

- (12) Display
- (13) Alarm light (red LED)

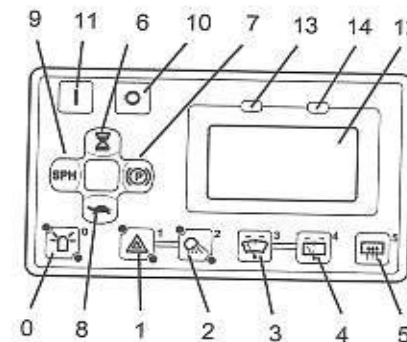



(14) Operation light (green LED)

Beacon lamp button

Press to switch on the beacon. The upper LED will light up. Press again to switch off.



Hazard warning lights button

Press to switch on the warning lights. Press again to switch off.



Rear working lights button

Press to switch on the rear working lights. Press again to switch off.



Front windscreen wiper button

Press up to 3 times:

- (1) intermittent
- (2) high speed
- (3) OFF

Hold to activate the screen washer.



Rear windscreen wiper button

Press to switch on the wiper. Press again to switch off. Hold to activate the screen washer.



Heated rear window button

Press to switch on the heated rear window. Press again to switch off. The heater switches off automatically after 15 minutes.

In models with heated seat (Option) this button allow to access a menu used to enable the heated rear window and the heated seat. MSG

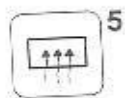

heated seat (option) is also equipped with an ON/OFF switch that must used in conjunction with the menu.

When the heated rear window or the heated seat are enabled, the relative indicator appears on the display. If both are enabled, the respective indicators appear in sequence.

3.4.1.1 Push button panel

(6) Hour meter / Clock

(7) Parking brake

(8) Low speed

(9) Power select

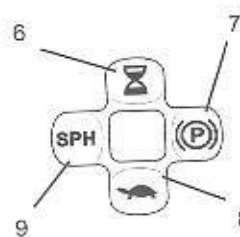

Hour meter button

Press to toggle between date, time, key switch ON hour meter (K), pump/drive hour meter (W), remaining key hours work time. Hold to access the hour meter menu. For details of this function, please refer to the OPERATOR MENU section of this manual.

Parking brake button

Press to switch on the parking brake. Press again to switch off.

Low speed button

Where enabled, this setting limits the maximum travel speed and lifting speed of the truck. Press to switch on low speed. Press again to switch off. Hold to access the Travel Settings. For details of this function, please refer to the OPERATOR MENU section of this manual.

This setting can be enabled or disabled by the Service Centre.



Power select button

Press to change the travel / load handling power mode; this functionality remains disabled if the forklift truck is in motion.

S mode (eco): setting for maximum operating time.

P mode (balance): setting for optimal balance between work performance and operating time.

H mode (performance): setting for highest work performance, and both travel and load handling performs maximally.

SPH (custom): setting defined by the operator using the Power Control menu

Hold to access the Power Control menu. For details of this function, please refer to the OPERATOR MENU section of this manual.

OK - OUT buttons

(10) OUT button

(11) OK button

The OK and OUT buttons are used to surf the Operator menu. The OK button may replace the ignition key switch function in some options configurations.

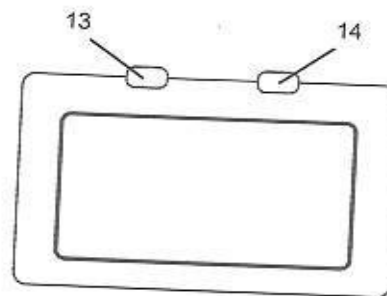

Alarm light - Operation light

(13) alarm light (red LED)

(14) operation light (green LED)

The alarm light blinks when an error has occurred. The operation light shows when the truck is switched on.

3.4.2 Display indicators

Main screen

The operating screen provides various information when the truck is running:

(1) battery charge level

(2) power mode

(3) travel direction

(4) time / date / hour meter

(5) steering direction

Steering direction is displayed only if the forklift truck is stationary or moving at low speed.

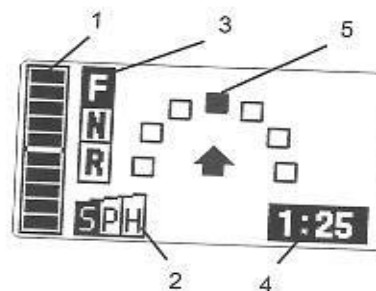

Battery charge level





Battery charge level	Battery charge level indicator Pb	Alarm light	Buzzer	Truck travel and lift speed
20% to 11%	Blinks continuously	Blinks briefly	-	Reduced
10% to 1%	Blinks continuously as full charge	Blinks continuously	-	Further reduced
0%	Blinks continuously as full charge	Blinks continuously	Sounds continuously	Load handling functions disabled while traveling

Power mode

It shows the currently selected operating performance/material handling mode.



Travel direction

Displays the travel direction currently selected.

F: forward

N: neutral

R: reverse

The travel direction is also shown by the steering direction indicator. An upwardly directed arrow indicates forward, and a downwardly directed arrow indicates reverse.



Time / Date / Hour meter

Displays the time (hours and minutes) or the date (day and month) or the hour meter (as set in OPERATOR SETTINGS MENU).



Steering direction

This indicator is only visible at low speed. At higher speed it is replaced by the speedometer.

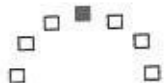

Low speed setting indicator (Option)

Indicates that the low speed setting is active.



OPS indicator

The indicator lights up when the operator vacates the seat. The operation of the truck remains inhibited until the operator resumes a correct position on the seat.

3



Seat belt lock recognition indicator

The warning light appears when the seat belt is not fastened. An audible warning is sounded by the buzzer. The operation of the truck remains inhibited until the operator fastens the belt.

Please refer to the MAIN FUNCTIONS section of this manual.

Service Centre can set this function as follows:

- Disabled
- Enabled; requires the seat belt fastened
- Enabled with OPS check; requires the operator sitting in the seat and the seat belt fastened

Shock sensor indicator (Option)

The truck systems have detected a collision. Please inform your supervisor.

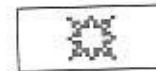

Multi-function display DX (Option)

Tilt indicator

The clockwise arrow indicates forward tilt, the counterclockwise arrow indicates backward tilt. The tilt angle of the mast is displayed in unit of 1 degrees.





3 OPERATION

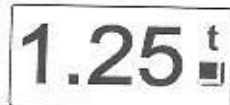

Load indicator

Activation of load indicator turns the main screen to the load indicator screen.

CAUTION

This function should be used as reference when conducting load handling operations, and not used in business dealings or as proof of actual weight.

NOTICE

- Use this function when traveling and load handling operations are stopped. The load indicator screen is not displayed while truck speed is detected.
- Always set the load to a height of approx. 500mm above the ground and set the mast vertically.
- The load weight is displayed for about 3 seconds in 0.01t units.
- If the load is less than 100kg, the meter will indicate 0.00t.
- The accuracy of the load meter drops while the load is oscillating. In that case, an indication will appear to notify the operator that the reading is inaccurate.

Over load alarm

The administrator may set a value above which the over load alarm is triggered, when the operator uses the load indicator. In this case the buzzer will sound.

On request, the Service Centre can set the alarm so that it comes on automatically when the set value is exceeded. However, the signal may be given erroneously also with lighter loads, due to load fluctuations during driving or due to an increase in load during lifting.

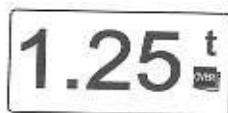

Maximum height limiter indicator

When the lift lever is operated upward and the forks reach the maximum height limiter position, the forks automatically stop there and buzzer sounds for a second. If the lift lever is operated upward at the height where forks have already exceeded the maximum height limiter position, the forks never rise and the buzzer also sounds for a second. Only the administrator can use the setting menu for "Maximum Height Limiter". If this setting is enabled, the maximum height limiter icon is displayed when starting the truck. Whenever the operator attempts to exceed the set height limit the forks are blocked.

Height limiter indicator (Option)

Indicates that the Height Limiter function is active. When it flashes, indicates that the forks have reached the memorized position.

3.4.3 Alarms

Certain errors are generated by incorrect operations that occur when starting the truck or operating the controls. These errors inhibit the operation of the truck temporarily, while at the same time causing an alarm icon to appear in the display. The majority of the errors in question are recoverable.

WARNING

If an error message persists even after taking the remedial measures indicated below, contact the Service Centre.

NOTICE

When driving the truck, keep an eye on alarm indicators and buzzers.



Parking brake error

Attempt made to set the truck in motion with the parking brake still applied. Release the brake and try again.

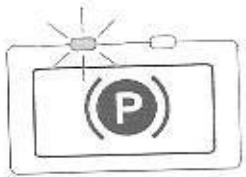

OPS error

Attempt made to operate the truck with the operator not positioned correctly on the seat. Release the accelerator pedal, return all levers to their neutral positions, resume a correct position on the seat and try again.

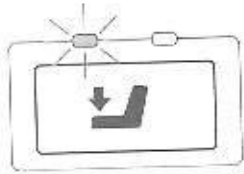

Drive errors

One of the following cases has occurred:

- Drive pedal pressed during the start-up sequence. Repeat the start-up sequence correctly.
- Truck vacated by the operator with the direction lever (if any) engaged. Shift the lever to neutral.
- Forward and reverse drive pedals (if any) depressed simultaneously. Press one pedal only.

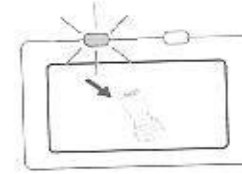
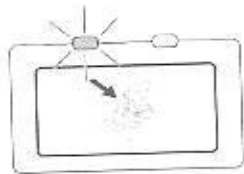
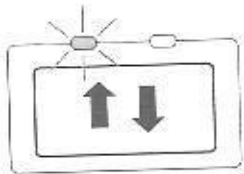
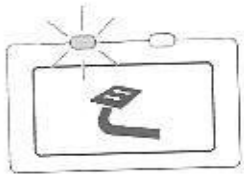

Lift error

One of the following cases has occurred:

- Load handling controls operated during the start-up sequence. Repeat the start-up sequence correctly.
- Load handling controls operated with the operator not positioned correctly on the seat. Place the controls in neutral, resume a correct position on the seat and try again.

3

Brakes alarm

Level of brake fluid low. Contact the Service Centre.

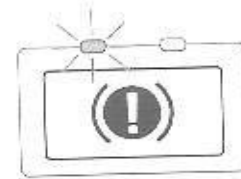

Voltage alarm

Residual voltage in the electrical controls of the truck. Wait until the icon disappears. In the meantime, do not open the battery hood.

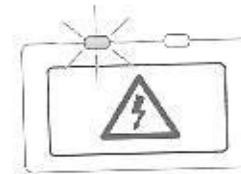

Overheating alarm

Truck overheating: performance levels are reduced in order to protect systems and devices, and if operation is prolonged, the truck will shut down. An error code indicates which component is overheating.

- PM: pump motor
- DM: drive motor
- PCR: pump control
- DCR: drive control

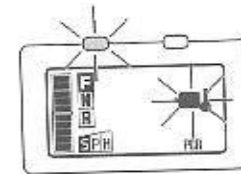



3 OPERATION

NOTICE

It is recommended to stop use as soon as possible and to park the truck until the alarm goes off, preferably in a cool place, sheltered from direct sunlight.

3.4.3.1 Air conveyer filter alarm

The air conveyer filter is clogged and needs to be cleaned. Please refer to the WEEKLY MAINTENANCE section of this manual.

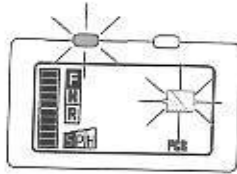

Unrecoverable error

All other messages, indicated by an alphanumeric code. Switch the truck off and on again: if the message persists, contact the Service Centre.

3.4.4 Operator settings menu

Hour meter menu

Hold the hour meter button to access the Hour Meter Menu. Press the hour meter button to edit the sequential display.



Key switch ON hour meter (KEYON)

Counts the time when the key switch is turned ON.

Hour meter (LAP)

Counts the time when the key switch is turned ON. Press OK and hold the button for more than two seconds to reset.

Pump hour meter (fork icon)

Counts the time when the pump motor is enabled in the power mode.

Drive hour meter (gear icon)

Counts the time when the drive motors are enabled in power mode or regenerative brake mode.

Motors hour meter (fork and gear icons)

Counts the time when any motor is enabled. Used as reference in total truck operating hours for technical servicing.

Odometer (ODO)

Counts the distance covered.

Trip meter (TRIP)

It counts the travel distance, and it can be reset. Press OK and hold the button for more than two seconds to reset.

Planned maintenance hour meter (MAINTENANCE HR)

When this setting is on, the preset interval for maintenance and the time since the last service are displayed.

Rental hour meter (RENT HR)

When this setting is on, the preset rental interval and the time passed, or alternatively the rental end date, are displayed.

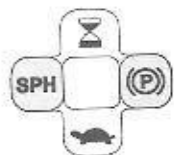

Clock menu

The parking brake and power selection buttons are used to increase or decrease the value. Press OK to confirm and proceed to the next value or press OUT to exit the menu.

The value sequence is:

Date: day/month/year (day of the week)

Display 12 h/ 24 h

Time: hours/minutes

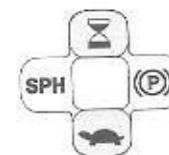
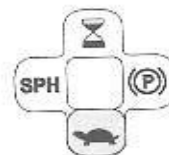

Travel settings menu

Hold the low speed button to access the travel settings menu. The hour meter and low speed buttons are used to select the required element. Press OK to confirm or press OUT to exit the menu.

Low speed

This menu is used to adjust the low speed setting. The clock and power selection buttons are used to increase or decrease the low speed value. Press OK to confirm or press OUT to exit the menu.

Speed alarm

This menu is used to enable an acoustic alarm to warn that the truck speed has exceeded a set value. The clock and power selection buttons are used to increase or decrease the speed value. Press OK to confirm or press OUT to exit the menu. If the speed is set to more than 50 km/h the low speed function is disabled: in this case "OFF" is displayed.

3



3 OPERATION

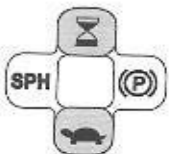
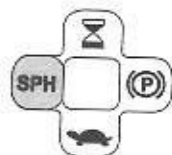

Power control menu

This setting can be enabled or disabled by the Service Centre.

Hold the power selection button to access the power control menu. This menu is used to set the SPH (custom) power mode for drive and lifting power. The hour meter and low speed buttons are used to select the required element. Press OK to confirm or press OUT to exit the menu.

Drive power

This menu is used to set the truck speed and acceleration.

Lift power

This menu is used to set the material handling speed and acceleration.

The procedure is that used for the drive and lift power settings. The clock and power selection buttons are used to increase or decrease the power value. Press OK to confirm or press OUT to exit the menu.

Automatic height control settings menu

To memorize the height position, access the travel settings menu. Use the clock selection and power buttons to select the height settings menu. After selection press OK to confirm and access the setting. The operator must lift the forks up to the height he wants to memorize. At this time, the setting screen displays the height relation between three memories and the current height. The operator can then select the memory to overwrite - A, B or C - using the clock selection and power buttons. Hold down OK for two seconds to overwrite the current height in the selected memory. If the memory is overwritten the "OK" and settings screens are displayed. Press OUT to exit the menu.

To memorize a height position there must be at least 100 mm (approx) difference between the three memorized heights.

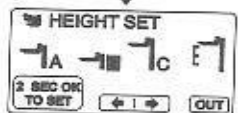

It is possible to clear all three memories at the same time. The cancellation screen is displayed by selecting the Height Settings Control menu in the Travel Settings menu. Hold OK for at least two seconds to clear all three memorized heights. The "OK" and settings screens will be displayed. Press OUT to exit the menu. This procedure does not clear the height limiter and maximum height limiter memories.

Height limiter settings menu (Option)

To set the height position, access the travel settings menu. Use the clock selection and power buttons to select the height limiter menu. After selection press OK to confirm and access the setting.

Once in the menu, lift the mast to the required fork height and select "SET" (use the clock and power control buttons to select) and hold down OK for more than two seconds until "OK" appears to confirm that the position has been memorized. The height limiter is now active. Press OUT to exit the menu.

To reset, enter the height limiter menu and select "CLR" (use the clock and power control buttons to select) and hold down OK for more than two seconds until "OK" appears to confirm that the position has been reset. The height limiter function is now disabled until new positions are memorized. Press OUT to exit the menu.

When the required position is memorized and the height limiter switch is enabled the function is active and the height limiter indicator is shown on the display. Whenever the operator attempts to exceed the set height limit the forks are blocked and a buzzer sounds. The forks can be lifted above the memorized height limiter position by releasing the height limiter switch.

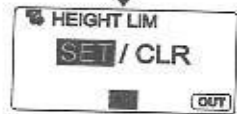
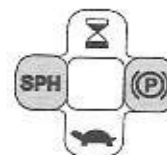



3.4.5 PIN code entry system (Option)

With this feature, the key switch is replaced with a ten-key pad. When starting the truck (by pressing the OK button), the operator must enter a PIN code. The PIN code consists of a sequence of five numbers. To activate the truck, the operator must enter the correct PIN code every time.

PIN code entry system can help to prevent any use of the truck by unauthorized persons; but is not an anti-theft security system.

Login operation

To access the truck the operator has to enter the PIN, and then press the LOGIN button (1) within 10 seconds. The green LED comes on and the buzzer emits a short sound, while the system checks the entered PIN. In case of a typing error, press the LOGOFF (2) button to reset the numbers entered.

If the PIN is correct, the buzzer emits a short sound, the green LED comes on and the truck starts, running according to the settings associated to the PIN code.

If the PIN is not correct, the buzzer emits a long sound and the truck does not start.

Logoff operation

If the operator of the truck vacates the driving seat for a period of time longer than that programmed by the Service Centre, the truck will shut down. However, it is also possible to switch off the truck beforehand by pressing the LOGOFF button. The green LED goes out, the red LED comes on and the buzzer emits a short sound, before the truck is switched off.

WARNING

Before switching off the truck, apply the parking brake.

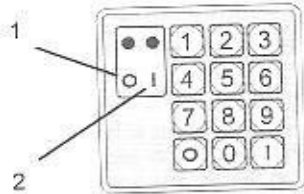
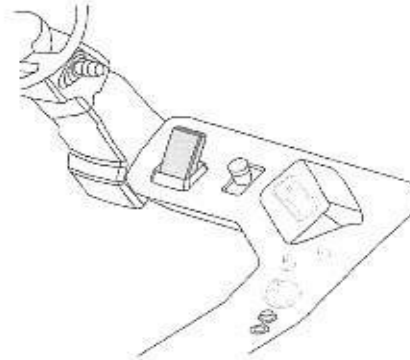

3.4.6 Smart Card reader (Option)

With this feature, the key switch is replaced with a card reader. To start the truck, the operator must place his card in front of the reader and press the OK button.

If the operator of the truck vacates the driving seat for a period of time longer than that programmed by the Service Centre, the truck will shut down. However, it is also possible to switch off the truck beforehand by pressing the OUT button. The green LED goes out, the red LED comes on and the buzzer emits a short sound, before the truck is switched off.

WARNING

Before switching off the truck, apply the parking brake.

3.5 INSPECTIONS

3.5.1 Inspection recommendations

WARNING

Even a small malfunction can cause a serious accident.

- Report any damage, malfunction, unusual or unsafe condition to your supervisor or the Service Centre immediately.
- Do not use the truck until it is repaired by the qualified service staff or at the Service Centre.



3 OPERATION

3.5.2 Pre-operation inspections

Pre-operation inspections table

Integrity
Truck alignment
Identity and capacity plates, warning labels
Damage, wear, leakage, looseness of parts (tires, frame, overhead guard, hydraulic system, seat belt, load handling system, etc.)
Flat tires (pneumatic tires)
Checks
Battery charge, lead battery vent caps in closed position
Operating conditions
Parking brake, brake pedal, horn, steering wheel, load handling system, safety devices
Traveling, steering, load handling functions and devices
Full extension and retraction of each hydraulic cylinder

⚠ WARNING

Never inspect for oil leaks by hand. Oil under pressure can penetrate your skin causing a severe injury. Wear gloves and use a piece of cardboard to find leaks.

Tires check

Damage, cracking and wear of tires and rims

Check the tires for damage and wear, and the rims for damage.

⚠ CAUTION

If the tires are damaged, or there is a marked difference in tire wear between front and rear or between left and right, or damaged rims are found, you should request an inspection from the Service Centre. Damaged or low tires could cause the tire to burst or skid.

Pneumatic tires pressure

If the truck is fitted with pneumatic tires, check the tires for flatness.

Load handling system inspection

Check for mast distortion and oil leakage from cylinders and piping. Check for integrity of collars and carriage end stops.

Check the forks and load backrest for cracks and bending. Check that the fork stoppers are correctly inserted in the corresponding notches.

If integrity defects or leakage are found, have the truck inspected at the Service Centre.

Chains inspection

With the truck parked on a level surface and the forks raised about 20 - 30 cm above the ground, inspect the chains for tension differences by pressing each chain with thumb or by noting the tilt in forks rail. If the chains do not have the same amount of tension, they need to be adjusted.

Check for integrity of chain anchoring bolts and that the adjusting nuts are locked by the cotter pins or seeger rings.

If any abnormality is found, have the truck inspected at the Service Centre.

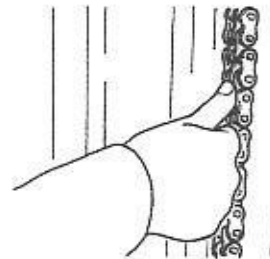

Steering system inspection

Carry out the inspection after switching on the truck.

Align the rear wheels for straight-ahead travel, and proceed to check for possible play in the steering wheel.

Turn the steering wheel and move it up and down to check that there is no looseness.

If anything out of the ordinary is discovered, have the truck checked over by the Service Centre.

While moving the truck slowly in a safe location, turn the steering wheel to the left and right and check for any unusual movement.

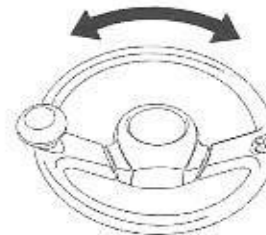



3.5.2.1 Braking system inspection

Brake pedal inspection

1. Depress the brake pedal fully, and check that a sufficient reaction can be felt.
2. When the pedal is kept down, make certain that it does not travel any further.
3. Check that there is no abnormal movement in the pedal either when depressed or when released.
4. If any irregularity is observed, contact the Service Centre.

Parking brake inspection

Check that the parking brake can be engaged and released correctly. If anything out of the ordinary is discovered, have the truck checked over by the Service Centre.

Brake effectiveness

Depress the brake pedal, checking that there is no irregularity in the braking action, and that the truck brakes in a straight line.

Apply the parking brake and insure that the truck can be stopped and held against moderate speed.

WARNING

If you should feel something abnormal even slightly, stop the truck operation immediately and have the truck inspected by the Service Centre.

Safety devices inspection

Plates and warning labels check

Check identification and capacity plates and warning labels if they are in-place, clean and can be read.

If missing, damaged or illegible, ask a supervisor or the Service Centre and replace them.

Overhead guard check

Check the overhead guard for bends, cracks and looseness.

Seat belt check

Before fastening the seat belt, check its strap for any cut, fray or loose stitching.

Check also tongue, buckle and retractor for any damage.

OPS indicator check

Sit on the seat, start the truck, and check that the OPS indicator is not visible on the display.

Be sure that the parking brake is ON, then leave the seat. Check that the OPS indicator is visible on the display.

CAUTION

In any anomaly is found, a malfunction may have occurred to the OPS.

- Park the truck in a flat and safe location, with the forks lowered and the parking brake applied. Remove the ignition key, if fitted.
- Contact the Service Centre.

SAS inspection

Check the SAS function to make certain that it is functioning properly.

Check the mast to make certain that it can be properly tilted either forward or backward and moved up. Also, make certain that the automatic fork leveling control is functioning properly.





3 OPERATION

⚠ CAUTION

If you should feel something abnormal even slightly, or when the spanner indicator lamp illuminates or blinks, or once an error code has appeared on the hour-meter display, immediately stop the operation in progress and park the truck in a safe location, apply parking brake and remove the key. Then, ask the Service Centre for an inspection.

Horn button check

Operate the horn to make certain that it sounds normally.

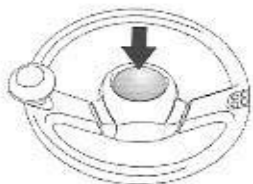

Rear-view mirror check

Check the rear-view mirror for any damage and adjust the mirror angle before operating the truck.

⚠ CAUTION

To avoid accidents, adjust the mirror angle before operating the truck. Never adjust the mirror angle while the truck is moving.

Lighting system check

Check that the lenses are intact and clean and that the lights work properly.

Beacon lamp check

Check integrity and functionality.

Blue LED warning light check

Check integrity and functionality.

Back-up buzzer check

Check functionality.

Cabin inspection

Check that the doors, the gas springs holding the doors open and the locks and hinges on the doors are all working properly.

Safety gates inspection

Check that the doors and the gas springs holding the doors open are all working properly.

3.5.3 Post-operation inspections

Integrity checks
Truck alignment
Damage, wear, leakage, looseness of parts (frame, overhead guard, hydraulic system, seat belt, etc.)
Flat tires (pneumatic tires)
Functional checks
Full extension and retraction of each hydraulic cylinder
Cleaning
Dirt removal

NOTICE

Performing inspections at the end of work will lead to early detection of failures and prevents malfunction of the truck.



4 SELF SERVICING

4.1 WEEKLY MAINTENANCE

4.1.1 Planned maintenance recommendations

To prevent malfunctions and accidents, it is important to perform self servicing. Lack of proper lubrication and servicing will quickly show up in increased breakdowns and shortening of the truck life.

Perform self servicing every week or every 40 hours of total operating hours (travel, steering and lifting), whichever comes first.

Record all results and file them for future reference. Have necessary adjustments or replacements performed by qualified service staff or by the Service Centre.

This chapter includes a broad array of devices. Not all of them are fitted in every truck model. Therefore, some operations are intended as "if the component is fitted".

Self servicing operations	
Tires	Check integrity Tighten bolts and nuts Check pressure (pneumatic tires)
Electric fan	Clean filter and conveyor
Heater fan	Clean (dusty environments)
Mast, Sideshift, Chain	Lubricate
Rear axle (4 wheels)	Lubricate
Hydraulic oil	Check level
Lead battery	Check electrolyte level and density Clean and lubricate terminals
Wiper fluid	Check level

The above items are concerned with inspection and lubrication. Replacement of lubricants will depend on the amount of contamination and foreign matter in them. Changes should be made to conform with the conditions of your workplace and equipment.

4.1.2 Hub nuts retightening

The hub nuts must be retightened uniformly in the sequence illustrated. For the correct wheel nut tightening torques, see below.

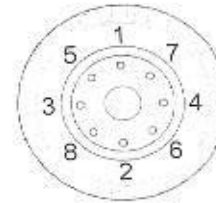
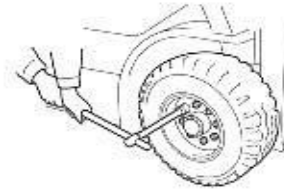

Front wheels

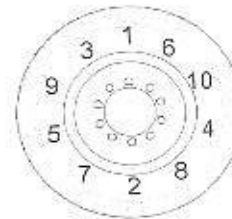

Rear wheels

Hub nuts tightening torque

Truck model	Wheel	Torque - Nm
all models	front	700-800
	rear	305



VEHICLE SERVICING



4.1.3 Battery terminals

A loose or corroded terminal causes failure in connection. Remove white powder, if any, from the terminal by pouring warm water over it to dissolve it and then apply grease (1) on the terminal. If the terminal is extremely corroded, remove it from the battery and brush off the corrosion using a wire brush or emery paper. Connect the terminal tightly to the battery and apply grease (1) on the terminal.

⚠ WARNING

- Always disconnect the battery plug before working on the battery or terminals.
- Remove the negative terminal (-) first, but replace it last.

4.1.4 Heater filter cleaning

Open the battery side hood. Remove the outer and inner side covers. Extract the heater filter and clean it with an air compressor.

NOTICE

Be sure to reinstall the filter before activating the heater.

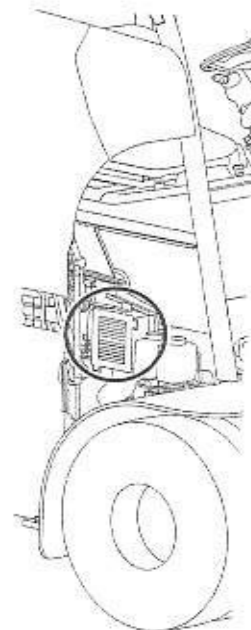
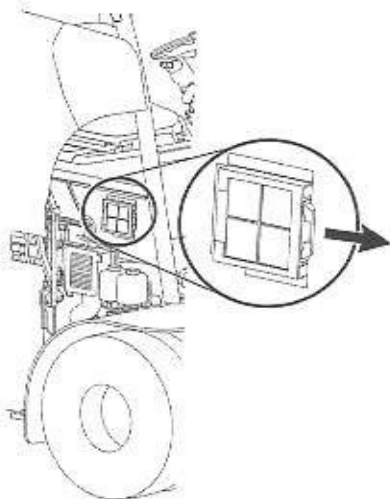

4.1.5 Air conveyor filter cleaning

Open the battery side hood. Remove the air conveyor cover. Extract the air conveyor filter and clean it with an air compressor.

NOTICE

Be sure to reinstall the filter before turning on the truck.

4.1.6 Lubricants and fluids

Lubricants and fluids service data

Point of application	Quantity	Type
Frame and mast; grease nipples	As required	Standard version: Mobilgrease Special or equivalent Cold storage version: Esso Beacon 325 or equivalent
Chain	As required	Interflon Fin Lube TF, Klüberoil 4UH1-32N, Rexnord kædespray REXOIL or equivalent
Hydraulic oil tank	Oil: varies according to mast type (*)	VG32; Wladoil HY SY HVI 32 or Agip Arnica 32 or equivalent
Power steering oil tank	5.5 L	VG32; Wladoil HY SY HVI 32 or Agip Arnica 32 or equivalent
Drive unit	2 x 0.8 L	VG150 SAE 80W/90 according MIL-L-2150C; API G15



Point of application	Quantity	Type
Battery	As required	Distilled or demineralized water
Wiper tank	2 L (+2 L with option: wiper on roof)	Standard version: Standard automotive wiper fluid Cold storage version: Low temperature automotive wiper fluid

(*) Please refer to the HYDRAULIC OIL LEVEL CHECK paragraph of this section.

NOTICE

Do not mix different types of oils

4.1.6.1 Lubrication

Lubrication chart

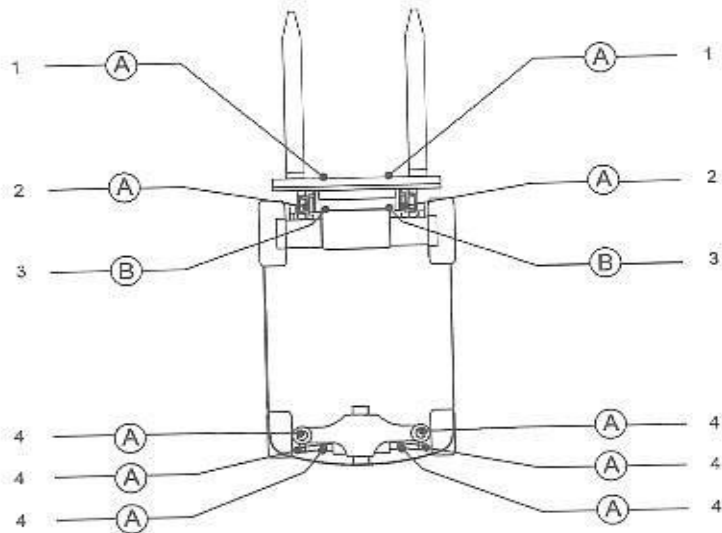

1	Sideshift
2	Mast guides
3	Chain
4	Rear wheels bearings
(A)	Grease
(B)	Chain spray

Mast lubrication

Chains (1) and guide channels (2).

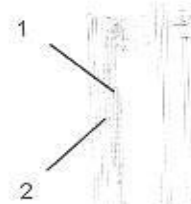

4

Sideshift lubrication

Clean the grease nipples thoroughly prior to lubrication. After lubrication, wipe off excess grease with a cloth.

Grease nipples (3) quantity varies accordingly to the sideshift type

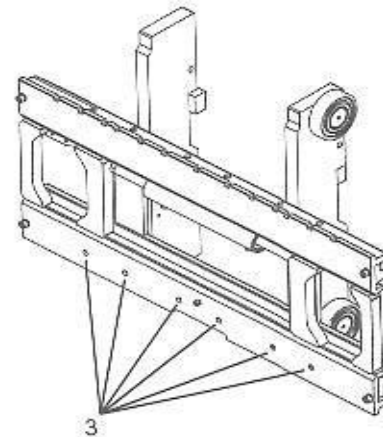



4 SELF SERVICING

Rear wheels bearings lubrication

Clean the grease nipples on each wheel thoroughly prior lubrication.

After lubrication, wipe off excess grease with a cloth.

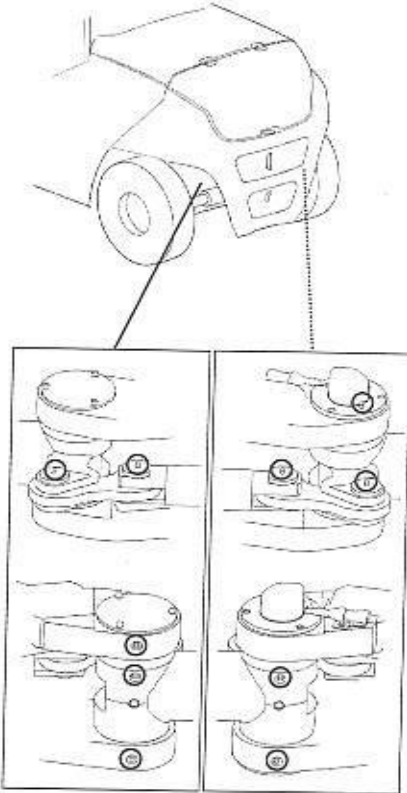

- (5) Remove the level gauge gently and check if the oil is up to the level line.
- (6) If the oil level is insufficient, add oil. Spilled and splashed oil must be wiped off thoroughly.

NOTICE

- Inspect the oil level by placing the level gauge on the opening of the oil supply inlet, without pushing the oil cap in.
- Be sure to refer to proper indication marking.

6.0 - 7.0 t

Mast height range - mm	Indication Marking	Oil quantity - L
0 - 4500	1	60
4501 - 5500	2	65
5501 - 7000	3	74

8.0 t

Mast height range - mm	Indication Marking	Oil quantity - L
0 - 4500	1	60
4501 - 5500	3	74
5501 - 7000	4	84

Lead battery electrolyte inspection

⚠ WARNING

The electrolyte used in battery contains diluted sulfuric acid, which causes burns and/or blindness. To inspect the electrolyte safely, be certain to follow the procedure described in the Manual for Safe Operation.

Hydraulic oil level check

- (1) Park the truck on level ground, switch it off and lower the forks to the ground.
- (2) Access the hydraulic oil tank by pulling down the oil tank panel on the left side of the truck.
- (3) Remove the oil cap.
- (4) Wipe the level gauge attached to the oil cap with a clean cloth, and insert it again into the tank.

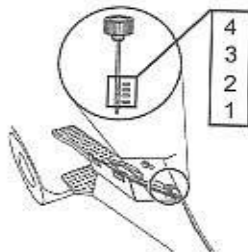



Wiper fluid check

The wiper fluid tanks can be filled up to the level of the plug.

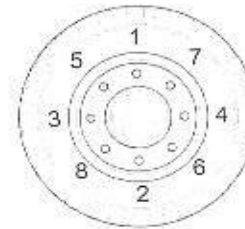
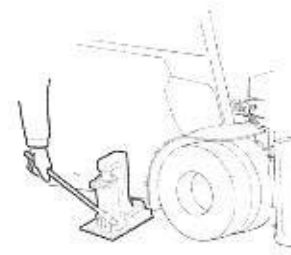
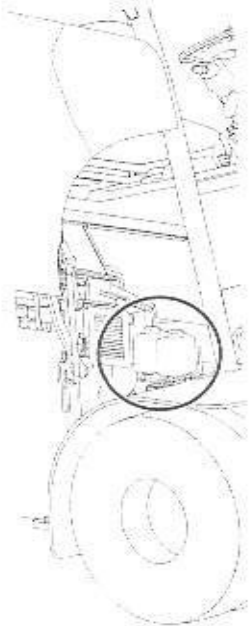

Front wheels replacement

1. Park the truck on a level surface.
2. Apply the parking brake and chock the wheels.
3. Tilt the mast backwards, raise the forks about 1 metre, and position the jack under the frame at a point near the front wheels. If the wheel is positioned on right side, lift the battery side hood.
4. Jack up the truck until the tires are about to clear the ground, and loosen the wheel nuts.
5. Jack up the truck so that the tires are completely clear of the ground. Remove the wheel nuts and the wheel.
6. To fit a wheel after replacing or repairing the tire, repeat the steps of the removal procedure in reverse order. The wheel nuts must be tightened uniformly in the sequence illustrated. For the correct wheel nut tightening torques, see below.
7. Drive the truck both forward and in reverse 2 or 3 times so as to check for any looseness in the wheel nuts, then retighten if necessary.

4

4.2 EXTRAORDINARY OPERATIONS

4.2.1 Tires replacement

Tires replacement precautions

CAUTION

Use proper safety precautions when jacking the truck. Never get under the forks or frame.

Tires service data

	6.0 t	7.0 t	8.0 t - 8.0 t H
Front	355/50-20	8.25-15	300-15
Rear	8.25-15	8.25-15	300-15



4 SELF SERVICING

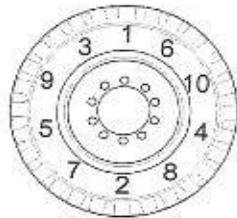

Rear wheels replacement

1. Park the truck on a level surface. Turn rear wheels by 90°.
2. Apply the parking brake and chock the wheels.
3. Position the jack under the rear axle.
4. Jack up the truck until the tires are about to clear the ground, and loosen the wheel nuts.
5. Jack up the truck so that the tires are completely clear of the ground. Remove the wheel nuts and the wheel.
6. To fit a wheel after replacing or repairing the tire, repeat the steps of the removal procedure in reverse order. Tighten the wheel nuts in the same sequence as for the front wheels. For the correct wheel nut tightening torques, see below.
7. Drive the truck both forward and in reverse 2 or 3 times so as to check for any looseness in the wheel nuts, then retighten if necessary.

Hub nuts tightening torque

Truck model	Wheel	Torque - Nm
all models	front	700-800
	rear	305

4.2.2 Battery replacement

Battery service data

Truck model	Length mm	Width mm	Height mm	Minimum required weight (with case) - kg	Maximum weight - kg	Voltage and rated capacity - V / Ah
all models	1037	1287	784	2682	2965	80 / 1120
				2690	2973	80 / 1240

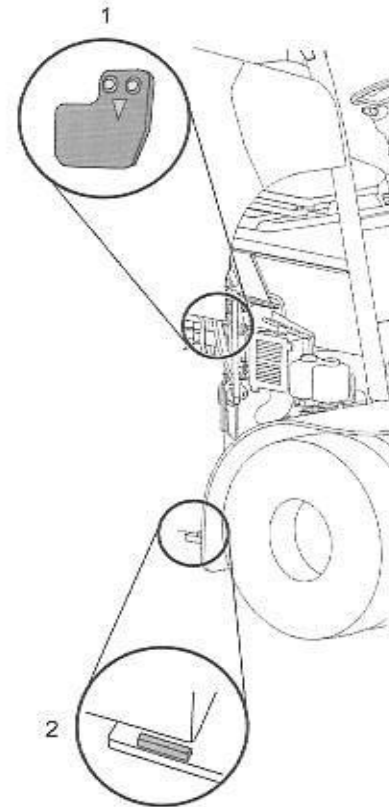

4.2.2.1 Battery side-out extraction

Fork pockets

⚠ WARNING

For details of this operation, please refer to the BATTERY HOOD section of this manual.

1. Open the battery side hood.
2. Disconnect the battery plug.
3. Remove the battery by picking up and pulling the tray with another forklift truck.

NOTICE

- When picking up the battery, lift it just over the lower guide (2).
- When inserting the new battery, the upper guide (1) can be used to estimate proper height, by scratching it with the battery upper portion during replacement operations.



Lead battery recycling or discarding

The forklift truck uses a lead acid battery. Materials contained in batteries are harmful to the environment and to human health; accordingly, batteries should be returned to manufacturers for recycling. When the life cycle of the battery is at an end (replacement with new battery) or if the entire truck is to be scrapped, special attention must be given to



environmental risks when arranging the disposal/recycling of batteries. Contact the manufacturer of the batteries for guidance on disposal and replacement.

4.2.3 Fuses replacement

Fuses service data

Location	Application	Voltage - V	Amperage - A
Rear compartment F1	key	80	5
Rear compartment F2	24V converter - standard devices	80	5
Rear compartment F3 (Option)	DC/DC 12V converter	80	5
Rear compartment F4 (Option)	24V converter - optional devices	80	15
Rear compartment FT1	right traction power fuse	80	500
Rear compartment FT2	left traction power fuse	80	500
Rear compartment FP	lift power fuse	80	500
Rear compartment F11 (Option)	heater	80	40
Rear compartment FS	steering power fuse	80	125
Operator compartment F6	boards supply	24	3
Operator compartment F7	horn	24	3
Operator compartment F9	traction motors fans	24	15
Operator compartment F10	boards power supply	24	3

Location	Application	Voltage - V	Amperage - A
Operator compartment F26 (Option)	spare	24	5
Operator compartment F8 (Option)	hydraulic oil tank cooler fan	24	7.5
Operator compartment F13 (Option)	front combination lights	24	5
Operator compartment F14 (Option)	beacon lamp	24	5
Operator compartment F15 (Option)	front working lights	24	5
Operator compartment F16 (Option)	rear combination lights, front turn signals	24	5
Operator compartment F17 (Option)	room light, reading light	24	5
Operator compartment F18 (Option)	heater fan	24	5
Operator compartment F19 (Option)	front wiper	24	5
Operator compartment F20 (Option)	rear wiper	24	5
Operator compartment F21 (Option)	wiper tanks motors	24	5
Operator compartment F22 (Option)	heated rear window	24	10

4



4 SELF-SERVICING

Location	Application	Voltage - V	Amperage - A
Operator compartment F23 (Option)	rear working lights	24	5
Operator compartment F24 (Option)	additional working lights	24	7.5
Operator compartment F25 (Option)	heated pneumatic seat	24	15
Operator compartment F31 (Option)	roof wiper	24	5
Operator compartment F27 (Option)	12V power supply plug	12	7.5
Operator compartment F28 (Option)	audio	12	7.5
Operator compartment F29 (Option)	12V power supply plug	12	7.5
Operator compartment F30 (Option)	heated seat	12	5

NOTICE

- Always replace a fuse with another of the same capacity.
- If the replacement fuse blows immediately on being fitted, have the electrical system checked by the Service Centre.

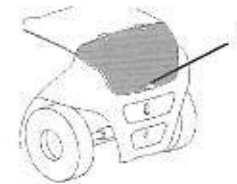
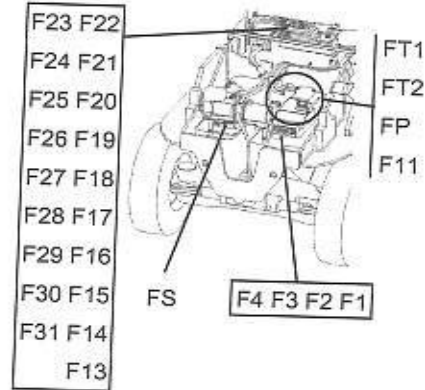

Fuses location

Fuses are located in three compartments, one placed behind the operator seat and the others placed under the rear hood.

Open and close the rear hood by the handle (1).



4.2.4 Hoisting

Lifting points are located on the marked hooking points in the frame.

⚠ WARNING

- Use fibre webbing, chain or wire rope of suitable strength, designed especially for lifting duties. A lifting frame with a shape like the one shown in the picture is also recommended. For details, please refer to the TRUCK WEIGHT section of this manual.
- Never use a cable that has kinks, distortions, fraying or friction damage.
- Never walk under a suspended forklift.
- Never use the counterweight to hoist the truck.

NOTICE

Protect the truck suitably from possible rubbing contact with the cable.

4.2.5 Transport

Disassembling

If the mast and/or counterweight must be removed for shipping or other reasons, remove the mast first and then remove the counterweight. Reattach the mast and counterweight in the reverse order, attaching the counterweight first and then the mast.

Please contact the Service Centre.

Reassembling tightening torques

Truck model	Components	Torque - Nm
all models	Mast to frame	1010
	Counterweight to frame	1354

Securing the truck for transport

⚠ CAUTION

The truck must be properly secured with appropriate restraint equipment (straps, wire cables or tensioning belts) when transported on a trailer or lorry.

Be sure to follow the cautions below before conducting the restraining procedure. If cautions are not followed, it could cause injury to people or damage to property.

- Make sure that restraint equipment has sufficient strength to secure the truck weight.
- The trailer or lorry used for transport must be equipped with means for restraining e.g. fastening hooks and the floor should be capable of supporting / securing the truck.
- Protect the truck with cushioning materials as appropriate to prevent damage during restraining or transporting the truck.
- Restraining must be carried out by specially trained staff and they must take necessary safety measures for each operation.
- If the truck is to be secured in a different way as is indicated in this manual, make sure to confirm safety on customer's responsibility.

Securing the truck

1. Chock all wheels using blocks.
2. Attach restraints to both sides (left and right) of the truck. Front restraints must be attached over the front wheels or, alternatively, at the top of the mast. Rear restraints must be attached to the draw bar. Rear restraints can be alternatively attached over the rear wheels only if specified.
3. Tighten the restraints with tensioners (ratchet handles or lever blocks).



Securing points

Please refer to the pictures for securing the truck with blocks and restraints. Always remember that the truck must be secured both in left and right side and in all wheels.

Front wheels securing points

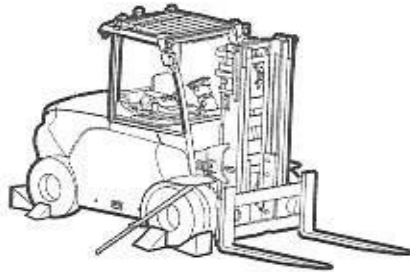

Mast securing points

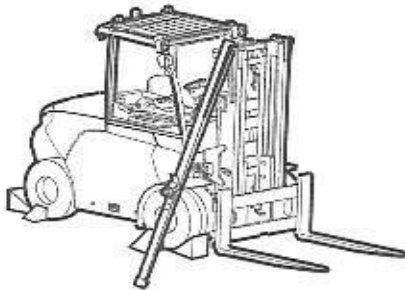

Draw bar securing points

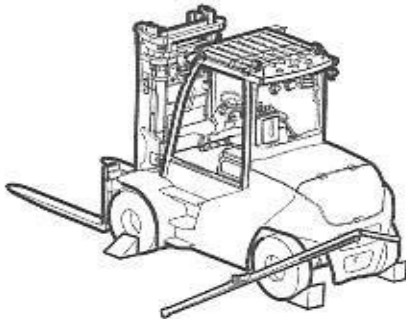

Rear wheels securing points

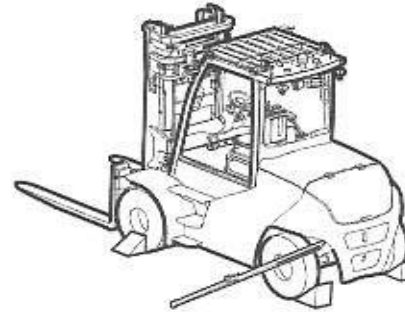

4.3 TROUBLESHOOTING

4.3.1 Truck misalignment

Does the truck lean abnormally to one side or to the other? If so, check for a flat tire (trucks fitted with pneumatic tires) or a problem with the undercarriage.

4.3.2 Blown fuse

When lights do not work or there is no response from the electrical circuit, the relative fuse may be blown.

4.3.3 Stuck fork carriage

It may happen on new trucks that frictional contact between surfaces will cause the fork carriage to become stuck when lowered. In this eventuality, simply raise the fork carriage momentarily to remove the impediment.



4.3.4 Fork carriage emergency lowering

In the event of malfunction while the forks are lifted and they cannot be lowered using the controls, this can be done by loosening the release screw on the directional valve under the battery hood. Having completed the operation, tighten the screw to its original position.

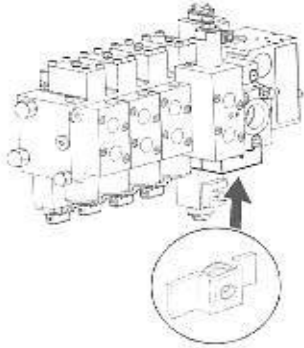

4.3.5 Towing the truck

Towing operation

- (1) Attach the towing rope to the forklift draw bar.
- (2) Release the parking brake.
- (3) Turn on the truck. Tow the truck at low speed.

⚠ CAUTION

- This operation is allowed only in emergency situations and for short distances. In any case it is recommended to contact the Service Centre.
- If the parking brake cannot be released, for instance for electronic failure, towing cannot be performed. For this operation contact the Service Centre.
- Use fibre webbing, chain or wire rope of suitable strength, designed especially for towing duties.

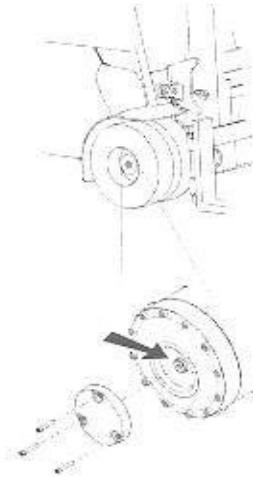

Parking brake emergency release

If the parking brake cannot be released, raise the front wheels from ground and properly chock the rear wheels using blocks. Remove the hub cap, the bearing and the gear shaft. When the towing operation is finished, raise the front wheels from ground and chock the rear wheels again, then reinstall the components in reverse order.

NOTICE

An oil leak will occur. Contact the Service Centre for oil refill before using the truck again.

4



5 TECHNICAL DATA

5.1 TECHNICAL SERVICING

5.1.1 Technical servicing indications

Regular inspection and maintenance is required to keep your forklift truck in perfect working order, and should be carried out by specialized technicians: to find out more, contact the Service Centre.

The technical servicing tables include a broad array of devices. Not all of them are fitted in every truck model. Therefore, some servicing entries are intended as "if the component is fitted".

Maintenance intervals refer to normal use of a standard truck. They are based on total truck operating hours, or months elapsed over the life cycle of the truck; whichever comes first. Total truck operating hours are indicated in the hour meter.

First 6 weeks - First 250 hours - only applies to new trucks; whether used in multiple shifts or not.

Every 6 months - Every 1000 hours

Every 12 months - Every 2000 hours

Every 5 years - Every 10000 hours

For trucks used on multiple shifts, servicing intervals must be reduced by the following values:

15% for 2 daily shifts

30% for 3 daily shifts

SERVICING METHOD

R	Replacement
I	Inspection for integrity (deformation, cracks, wear, rust, corrosion, leaks, abnormal noise, etc.) and operating conditions (if applicable); repair or replacement if required
M	Measurement; repair or adjustment if required
C	Cleaning
L	Lubrication
T	Tightening

5.1.2 Periodic replacements

REPLACEMENT CYCLE (Based on total hours operation or months elapsed during the life cycle of the truck, whichever is sooner)	first 6 weeks	every 6 months	every 12 months	every 60 months
	first 250 hours	every 2000 hours	every 10000 hours	every 10000 hours
Drive unit oil	R	R		
Hydraulic oil		R		
Hydraulic oil filter / filters		R		
Hydraulic oil tank breather filter	R	R		
Electric power steering oil		R		
Electric power steering oil filter		R		
Electric power steering tank breather filter		R		
Oil control valve fitting filters		R		
Brake fluid / oil		R		
Mast support bushings		R		
Control unit thermal paste				R
Pump coupling silicon paste				R
Power steering rubber parts				R
Service brake and parking brake hoses				R
Steering system hoses				R
Tilt cylinder hydraulic hoses				R
Load handling system hoses				R
Chains				R
Chains securing tie rods				R
Swing lock cylinder				R

The table below includes additional servicing for the following Special Specification models: Fisherman, Rustproof, Cold storage.

REPLACEMENT CYCLE (Based on total hours operation or months elapsed during the life cycle of the truck, whichever is sooner)	every 12 months
	every 1000 hours
Load handling system hoses	R
Chains	R
Chains securing tie rods	R



5.1.3 Periodic maintenance

MAINTENANCE CYCLE (Based on total hours operation or months elapsed during the life cycle of the truck, whichever is sooner)	first weeks	6 every months	6 every months	12 every months
	first hours	250 hours	every 1000 hours	every 2000 hours
DRIVE SYSTEM				
Wheels				
Tires general status			I	←
Tires treads	I, C		I, C	←
Wheel discs and rims integrity	I		I	←
Hub nuts	T		T	←
Front and rear wheel bearings	T		I, L, T	←
Pneumatic tires pressure	M		M	←
Rear axle				
General status			I	←
Axle beam	T		L, T	←
Hub play	I		I	←
Mechanical end stroke			I	←
Steering cylinders	I		I, T	←
Steering king pin			I	←
Linkages play			I	←
POWER TRANSMISSION SYSTEM				
Front Axle / Drive units				
General status			I, C	←
Bolts and nuts			T	←
Oil screw plugs			I, C, T	←
Air breazer			I, C	←
Oil condition and level	I, M		I, M	←
ELECTRICAL SYSTEM				
General				
Truck insulation			I	←
Static strap			I	←
Motor				
General status and operating conditions			I, C, T	←
Insulation resistance			I	←
Power cables			T	←
Rotation sound			I	←

MAINTENANCE CYCLE (Based on total hours operation or months elapsed during the life cycle of the truck, whichever is sooner)	first weeks	6 every months	6 every months	12 every months
	first hours	250 hours	every 1000 hours	every 2000 hours
Battery				
Upper portion			I	←
Case			I	←
Plug			I, C	←
Terminals			I, C	←
Power cables			I	←
Insulation resistance			I	←
Charging level			I	←
Electrolyte level and relative density			M	←
Voltage of each cell after charging				M
Magnetic switch - Contactors				
Arc shooter mounting			I	←
Contacts			I, C, T	←
Main circuit lead wire mounting			I, T	←
Coil mounting			T	←
Connected cables			T	←
All connected devices operating conditions and timing			I, M	←
Microswitch - Potentiometers				
Installation			I, T	←
Timing			M	←
Direction switch				
Integrity and operating conditions			I	←
Wiring connections			I	←
Electronic control unit				
General status			I, C	←
Case			C	←
Electric fan			I, C	←
Electric fan filter and convoyer			C	←
Power cables			T	←
Wiring connections			I	←
Connectors			I	←
Alarms in logbook			I	←
Fuses and relays				
Wiring			T	←



5 TECHNICAL DATA

MAINTENANCE CYCLE (Based on total hours operation or months elapsed during the life cycle of the truck, whichever is sooner)	first weeks	6 every months	6 every 12 months
	first hours	250 every 1000 hours	every 2000 hours
All functions protected by fuses and relays		I	←
Wiring			
Harness		I, T	←
Harness coating		I	←
Connections		T	←
Connections taping condition		I	←
STEERING SYSTEM			
Steering wheel			
Play	I, T	I, T	←
Steering valve			
General status	I	I	←
Mounting	T	T	←
Maximum pressure		M	←
Steering system			
Steering angle			I
Power steering - Hydraulic steering motor			
General status		I	←
Mounting and linkage		T	←
Hoses			I
BRAKING SYSTEM			
General			
General status		I	←
Bleeding		I	←
Brake fluid / oil level		M	←
Low level warning light			I
Hoses			I
Accumulator performance and recharge pressure		I	M
Brake pedal			
Linkages	I	I	←
Stroke, return stroke and play		I	←
Braking performance		I	←
Parking brake			
Switch		I	←
Lever pull margin and operating force		I	←

MAINTENANCE CYCLE (Based on total hours operation or months elapsed during the life cycle of the truck, whichever is sooner)	first weeks	6 every months	6 every 12 months
	first hours	250 every 1000 hours	every 2000 hours
Magnetic discs status and clearance		I, C	←
Rod and cable		I, T	←
Braking performance		I	←
Brake discs			
General status			I
LOAD HANDLING SYSTEM			
Forks			
General status		I	←
Heels		I	←
Welded portions		I	←
Fork fingers alignment		I	←
Positioning pins		I, L	←
Mast and lift bracket			
Guides	I, L	I, L	←
Pads	I, L	I, L	←
Grease nipples	I, L	I, L	←
Roller and roller pin	I	I	←
Sideshift general status	I	I	←
Sideshift grease nipples	L	L	←
Support bushings	I, L	I, L	←
Fork carriage	I	I	←
Welded portions		I	←
Fixing bolts	I	I, T	←
Chain			
General status, tension, elongation	I, L	I, L	←
Pulley	I	I	←
Securing tie rods	I, L	I, L	←
Anchoring bolts and nuts	I, L, T	I, L, T	←
Wheels status and revolution	I	I	←
Attachments			
General status and installation		I	←
HYDRAULIC SYSTEM			
Cylinders			
General status		I	←



MAINTENANCE CYCLE (Based on total hours operation or months elapsed during the life cycle of the truck, whichever is sooner)	first weeks	6 every months	6 every months	12 every months
	first hours	250 hours	1000 hours	2000 hours
Cylinders rod and rod end			I, T	←
Tilt cylinders mountings			I, T	←
Mast cylinders mountings			I, T	←
Natural drop and natural forward tilt			I	←
Lifting and lowering speed			I	←
Uneven movement			I	←
Hydraulic pump			I	←
General status			T	←
Fixing bolts				
Hydraulic oil tank			I	←
General status			I	←
Oil strainer			I, M	←
Oil condition and level				
Hydraulic oil filter			I, C	←
General status				
Control levers			I, T	←
General status				
Oil control valve			I	←
General status			I	←
Safety valve				M
Relief pressure				
Cooling system			I, C	←
Oil cooler general status				
Hoses and piping			I	←
General status			T	←
Linkages				
SAFETY DEVICES, etc.				
Frame				
General status				I
Fixing bolts				T
Hoods gas springs, doors locks			I	←
Overhead guard			I	←
General status			I	←
Welded portions				

MAINTENANCE CYCLE (Based on total hours operation or months elapsed during the life cycle of the truck, whichever is sooner)	first weeks	6 every months	6 every months	12 every months
	first hours	250 hours	1000 hours	2000 hours
Vibration dampers			I	←
Backrest				
General status			I	←
Mountings			T	←
Seat				
General status			I	←
Seat belt			I	←
Mountings			T	←
OPS				
Operating conditions	I		I	←
Emergency stop button				
Operating conditions			I	←
Instruments				
Operating conditions			I	←
Horn				
Operating conditions and mountings			I	←
Contact ring and contact spring				L
Lighting system				
Operating conditions and mountings			I	←
Turn signals				
Operating conditions and mountings			I	←
Back-up buzzer				
Operating conditions			I	←
Blue led rear warning light				
Operating conditions			I	←
Rear view mirrors				
General status			I, C	←
Cabin				
Roof			I	←
Doors and windows, doors joints			I, L	←
Windscreen wipers			I	←
Heater			I	←
Heater filter			C	←
Safety gates				



5 TECHNICAL DATA

MAINTENANCE CYCLE (Based on total hours operation or months elapsed during the life cycle of the truck, whichever is sooner)	first weeks	6 every months	6 every 12 months
	first hours	250 every 1000 hours	every 2000 hours
General status and operating conditions			←

The table below includes additional servicing for the following Special Specification models: Fisherman, Rustproof, Cold storage.

MAINTENANCE CYCLE (Based on total hours operation or months elapsed during the life cycle of the truck, whichever is sooner)	every 6 weeks
	every 250 hours
LOAD HANDLING SYSTEM	
Mast and lift bracket	
Guides	I, L
Pads	I, L
Grease nipples	I, L
Roller and roller pin	I, L
Sideshift grease nipples	L
Support bushings	I, L
Fork carriage	I, L
Chain	
General status, tension, elongation	I, L
Pulley	I, L
Securing tie rods	I, L
Anchoring bolts and nuts	I, L
Wheels status and revolution	I, L, T

SAS periodic maintenance

MAINTENANCE CYCLE (Based on total hours operation or months elapsed during the life cycle of the truck, whichever is sooner)	first weeks	6 every months	6 every 12 months
	first hours	250 every 1000 hours	every 2900 hours
S.A.S.			
Operating conditions			←
Wire harnesses			←
Functional parts mountings		I, T	←
Sensor mounting portion		I, T	←
Load sensor			
Swing lock cylinder performance			

5.2 NOISE AND VIBRATIONS LEVEL

Level	
Noise	65.8
Vibration	0.6 +/- 0.05

Noise level (LPA) according to EN 12053 - dB (A), Uncertainty K = 4 dB (A)

Overall truck body vibration to EN 13059 - m/s², Uncertainty K = 0.3 x a m/s² - (a: listed value)

- The vibration values shown above are obtained from the measurements in accordance with EN 13059.
- The magnitude of hand arm vibration of lift trucks is 2.5m/s² or below as defined in EN 13059.
- The whole body vibration values shown above cannot be used for calculating 8 hour vibration exposure in 2002/44/EC (Vibration Directive). If calculated according to the general forklift operation pattern, the result will be lower than 0.5 m/s².
- The sound pressure values shown above can be used as the sound level at operators' ears. (Values are in accordance with EN 12053 measurement methods).



5.3 TRUCK DIMENSIONS

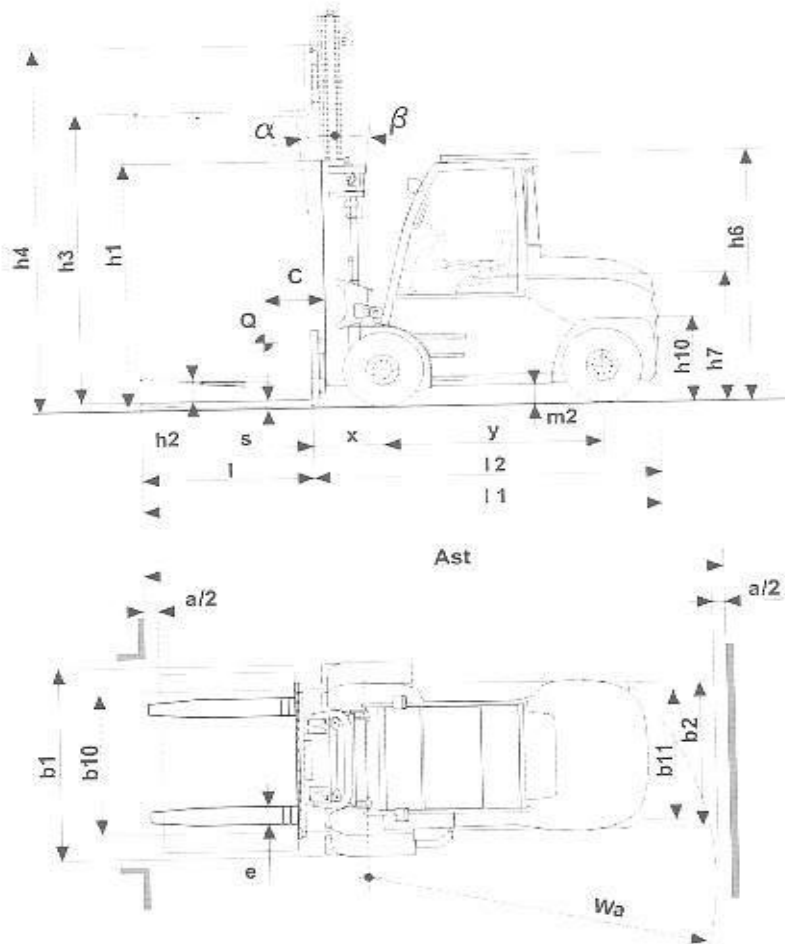

Dimension	truck model			
	6.0 t	7.0 t	8.0 t	8.0 tH
h2	100	←	←	←
h3	3300	←	←	←
h4	4237	4337	4255	4480
h6	2835	←	←	←
h7	1710	←	←	←
h10	785	←	←	←
m1	220	←	←	←
m2	210	←	←	←
l1	4680	4690	4695	5450
l2	3480	3490	3495	3650
x	700	710	715	750
y	2300	←	←	←
c	600	←	←	900
s / e / l	60 / 200 / 1200	←	←	70 / 200 / 1800
Wa	3005	←	←	3111
Ast (with pallet 1200 mm long)	4905	4915	4920	5061

The data are expressed in mm and refer to the standard truck with mast V3300 and superelastic tires.

5.4 TRUCK WEIGHT

Truck model	Weight (with battery) - kg
6.0 t	12765
7.0 t	13476
8.0 t	14461
8.0 tH	15918

Dimension	truck model			
	6.0 t	7.0 t	8.0 t	8.0 tH
b1	1660	2004	2141	2141
b10	1328	1510	1575	←
b11	1406	←	1394	←
α / β	5 / 8	←	←	←
h1	2620	2720	2620	2670