



T-210DL25 4WD/P/N-EN Rev. 0

Instruction manual

Combistar Scissor lift

T-210DL25 4WD/P/N



© 2009, HOLLAND LIFT INTERNATIONAL B.V., Hoorn, the Netherlands.

No part of this publication may be copied and/or published by means of printing, photocopying, microfilm or any other way whatsoever, without the prior written permission of HOLLAND LIFT INTERNATIONAL B.V.



Table of contents

1	General information	5
1.1	Use of this instruction manual	5
1.1.1	Objective	5
1.1.2	Symbols used in this instruction manual	5
1.2	Standard equipment	5
1.3	Additional documentation	5
1.4	Optional extras	6
1.5	CE marking.....	6
1.6	Scissor lift identification (type plate)	6
1.6.1	Location of the type plate	6
1.7	Delivery conditions and warranty	7
1.7.1	Delivery conditions	7
1.7.2	Warranty.....	7
1.8	Intended use and modifications.....	7
1.8.1	Intended use.....	7
1.8.2	Modifications	7
1.9	Service and technical support	8
2	Safety.....	9
2.1	Emergency procedures	9
2.1.1	Emergency stop	9
2.1.2	Contact with electrical (high voltage) cables	9
2.2	Safety instructions	9
2.2.1	General information.....	9
2.2.2	Safety instructions during normal use	10
2.2.3	Safety instructions during maintenance	11
2.2.4	Safety instructions when working on the electrical system	11
2.2.5	Safety instructions when working on the hydraulic system	11
2.3	Liability	11
2.4	Users	12
2.5	Intended use.....	12
2.6	Decalls on the scissor lift.....	13
2.6.1	Decalls on the front of the scissor lift.....	13
2.6.2	Decalls on the left-hand side of the scissor lift	14
2.6.3	Decalls on the right-hand side of the scissor lift	15
2.6.4	Decalls on the control box and on the platform	16
2.6.5	Decalls in the compartments for the hydraulic oil reservoir and the valves/electronics.....	17
2.6.6	Decalls in the compartment for the diesel engine and the central grease lubrication system.....	18
2.7	Location of the safety devices on the scissor lift	20
2.7.1	Emergency stop button	21
2.7.2	Safety prop	21
2.7.3	Protective scissor skirt.....	21
2.7.4	Driving alarm - visual.....	21
2.7.5	Emergency descent device	22
2.7.6	Driving alarm – acoustic	23
2.7.7	Speed limiter	23
2.7.8	Tilt indicators	24
2.7.9	Mechanical overload safety device	24
2.7.10	Lifting cylinder safety device	26
2.7.11	Line/hose fracture safety device.....	26
3	Controls.....	27
3.1	The control box.....	28



3.1.1	The main control panel	29
3.1.2	Outriggers control panel	30
4	Machine compartments.....	31
4.1	Hydraulic oil compartment	31
4.2	Valve and electrical compartment	32
4.3	Main switch.....	33
4.4	Electronics box	34
4.4.1	Control panel on the electronics box	34
4.4.2	Fuses.....	35
4.5	Diesel engine and grease lubrication system compartment	36
4.6	Diesel engine compartment.....	36
4.7	Fuel tank/grease lubrication system compartment.....	37
5	Normal use.....	38
5.1	Preparations before use	38
5.2	Starting	38
5.3	Turning off	40
5.4	Platform during transport.....	40
5.5	Oscillating axle	40
5.6	Automatically levelling the outriggers	41
5.7	Central grease lubrication system (optional)	42
5.7.1	Easy Lube Systems™ central grease lubrication system	42
6	Transport.....	44
6.1	Towing.....	44
6.1.1	Introduction.....	44
6.1.2	Releasing the multiple disc brakes.....	44
6.1.3	Point of special interest	45
6.2	Transport.....	45
6.2.1	Introduction.....	45
6.2.2	Points of attention.....	46
7	Maintenance	47
7.1	Maintenance overview.....	47
7.1.1	Protective scissor skirt.....	48
7.2	Overviews.....	49
7.2.1	Lubrication points	49
7.2.2	Tightening torques.....	50
7.3	Maintenance procedures.....	50
7.3.1	Installing and removing the safety prop.....	50
7.3.2	Topping up the hydraulic system.....	51
7.3.3	Lubrication.....	51
7.3.4	Check the tilt safety device.....	51
7.3.5	Inspecting the scissor mechanism	51
8	Rectifying faults.....	53
9	Disposal	54
9.1	Introduction.....	54
9.2	Disposal procedure	54
10	Technical specifications	55
10.1	Technical specifications for T-210DL25 4WD/P/N	55



T-210DL25 4WD/P/N-EN Rev. 0

1 General information

1.1 Use of this instruction manual

1.1.1 Objective

This instruction manual is intended for the users of the following scissor lift:
T-210DL25 4WD/P/N

1.1.2 Symbols used in this instruction manual



Comment

A comment gives additional information.



Note!

If an instruction with this symbol and title is ignored, it may result in the scissor lift becoming damaged.



Warning

If an instruction with this symbol and title is ignored, it may lead to serious physical injury or serious damage to the scissor lift.

1.2 Standard equipment

1. Control box with a plug-in connection, which can be used on the bottom carriage and on the platform.
2. Auxiliary switch in the valve/electrical compartment for raising and descending movements.
3. Proportional drive.
4. Unidirectional extendable platform.

1.3 Additional documentation

- Documentation set for the HATZ[®] diesel engine.
- Documentation set for central grease lubrication system (optional).
- Parts catalogue.
- Electrical and hydraulic diagram.
- Logbook.



T-210DL25 4WD/P/N-EN Rev. 0

1.4 Optional extras

1. 230 V AC connection on the platform.
2. Flashing lights in addition to the acoustic driving alarm.
3. Possibility to drive the scissor lift when fully extended.
4. Easy Lube Systems™ central grease lubrication system (10 lubrication points).
5. Fully automatic central grease lubrication system (54 lubrication points).
6. Generator.
7. Non-marking tyres.

1.5 CE marking

See the Declaration of Conformity.

1.6 Scissor lift identification (type plate)



Note!

Never remove the type plate.

The type plate contains information specific to the scissor lift.

1.6.1 Location of the type plate

The scissor lift's type plate is located behind the front left-hand wheel.



Type plate

The type plate contains the following information:

1. The manufacturer's name, address and telephone number.
2. The model.
3. The total weight (kg).
4. The chassis number.
5. The year of construction.
6. The nominal power (kW).



T-210DL25 4WD/P/N-EN Rev. 0

7. The maximum permissible weight on the platform when retracted (kg).
8. The maximum permissible weight on the platform when extended (kg).
9. The maximum horizontal force (N).
10. The maximum angle of inclination (°).
11. The maximum wind speed (m/s).
12. The maximum tilt (°).
13. The maximum height (m).
14. The maximum height when mobile.
15. The minimum permissible temperature (° C).
16. The maximum operating pressure (bar).

1.7 Delivery conditions and warranty

1.7.1 Delivery conditions

HOLLAND LIFT INTERNATIONAL B.V. delivers products in accordance with the delivery and payment conditions issued by the Metaalunie.

1.7.2 Warranty

For the warranty period, see the delivery conditions.

1.8 Intended use and modifications

1.8.1 Intended use

The scissor lift is only intended to be used to allow people to work at a height. The platform's maximum load (see type plate) must not be exceeded under any circumstances. Any other use is contrary to the scissor lift's intended use.

1.8.2 Modifications

Modifications may only be made to the scissor lift after written permission has been given by the management of **HOLLAND LIFT INTERNATIONAL B.V.**

The information contained in this instruction manual is based on the information regarding constructions, material properties and work methods that was known by us at the time of publication. We, therefore, reserve the right to make construction modifications. For this reason, **HOLLAND LIFT INTERNATIONAL B.V.** also reserves the right to make alterations to the content of the instruction manual without the need to give prior notification.

Components may only be replaced by components provided by **HOLLAND LIFT INTERNATIONAL B.V.** or components which can be considered to be of a comparable quality. **HOLLAND LIFT INTERNATIONAL B.V.** reserves the right to decide whether these components are of a comparable quality. The manufacturer can only be held liable if a written declaration stating that the components are of a comparable quality has been received from the manufacturer.



T-210DL25 4WD/P/N-EN Rev. 0

1.9 Service and technical support

HOLLAND LIFT INTERNATIONAL B.V.

Anodeweg 1

1627 LJ Hoorn

The Netherlands

T +31 (0)229-285555

F +31 (0)229-285550

E service@hollandlift.com

W www.hollandlift.com



2 Safety

2.1 Emergency procedures

2.1.1 Emergency stop

To disable all of the scissor lift's functions:

- Press the emergency stop button.

2.1.2 Contact with electrical (high voltage) cables

Observe the following if the scissor lift comes into contact with electrical (high voltage) cables:

1. Remain on the platform.
2. Move the scissor lift from the danger area.
3. Make sure bystanders do not touch the scissor lift.
4. Remove the electrical charge from the electrical (high voltage) cables.
5. Exit the scissor lift when the electrical (high-voltage) cable no longer carries an electrical charge.

2.2 Safety instructions

2.2.1 General information

- Avoid any situation that may endanger the users of the scissor lift or any bystanders.
- It is strictly forbidden:
 - To attach overhanging loads to the scissor lift.
 - To attach advertising boards or banners to the scissor lift.
 - To increase the platform's surface area.
 - To stand on the platform's railings.
 - To raise the height of the platform's floor.
 - To tow the scissor lift on public roads.
- After every (large) repair, the scissor lift must be inspected and approved by an expert.
- If any modifications or repairs are carried out which may affect the scissor lift's stability, strength or performance, the scissor lift must be reinspected and approved by **HOLLAND LIFT INTERNATIONAL B.V.**
- Any inspections, tests, repairs or modifications must be recorded in the scissor lift's logbook.
- The weighted root mean square acceleration value (vibrations) that the user is subjected to during use of the scissor lift is not greater than 2.5 m/s².
- The noise produced by the scissor lift in the work area at a distance of 7 metres and at a maximum load is not greater than 75 dB(A).
- Exposure to the noise over a long period of time may have a harmful effect on the ears if ear protection is not worn.



T-210DL25 4WD/P/N-EN Rev. 0

2.2.2 Safety instructions during normal use

- Only use the scissor lift under the following conditions:
 - There is no visible damage to the scissor lift.
 - All the functions work.
 - All the safety devices work.
 - The hydraulic system does not leak.
 - The hydraulic system contains the correct quantity of oil.
- Lock the box covers on the bottom carriage.
- Do not touch the scissor lift's moving parts or hinged components (e.g. the scissor mechanism or the steering gear).
- Make sure the driving area and the work area are:
 - Sufficiently flat and able to support the weight of the scissor lift.
 - Sufficiently lit.
 - Free of obstacles.
 - Free of snow and ice.
- Make sure the scissor lift cannot touch any fixed or moving obstacles.
- Make sure no objects can fall from the platform (e.g. tools).
- If tools which may cause a fire are used on the platform, then there must be a fire extinguisher on the platform.
- The scissor lift may only be driven when fully extended (21 m) if it is driven in an enclosed space on a completely flat surface which is able to support the weight of the scissor lift. The user must be aware of this. An extra safety requirement is that the scissor lift must always be operated by two people at all times. One person must work on the platform and the other person must remain on the ground. They can maintain contact with each other using communication equipment.

In normal situations, the 8-metre stop should work. The key switch is in the "0" position by default. This means that it is possible to drive the scissor lift when it is extended up to a height of 8 metres. Position "1" means: it is possible to drive the scissor lift when it is extended to the maximum height. The maximum speed is 0.5 km/h when the scissor lift is extended above a height of 4 m. The key switch is located on the electrical box.
- Only charge the scissor lift's battery in an area that is well ventilated and where a naked flame and smoking are forbidden.
- Important conditions concerning driving up or down inclines in the scissor lift's longitudinal direction:
 - See the technical information in the instruction manual for the maximum incline that the scissor lift can be driven on.
 - The maximum load when driving up an incline is 80 kg (1 person).
 - Place the platform in the lowest position.
 - Select the slowest speed.
 - Do not make any sharp steering movements when driving up an incline.
 - Drive up an incline with the non-driven wheels.
- It is strictly forbidden:
 - To operate the scissor lift from the ground using the control box (except for transport reasons or when carrying out maintenance work on the scissor lift).
 - To use the scissor lift to carry out work on or near electrical (high voltage) cables.
 - To use the scissor lift to work in an area where there is a risk of an explosion.



T-210DL25 4WD/P/N-EN Rev. 0

2.2.3 Safety instructions during maintenance

- Always wear the required safety equipment (e.g. safety goggles, ear protection, helmet) when carrying out maintenance work on the scissor lift.
- Prevent the scissor lift from being able to roll away. For example, place chocks against the wheels.
- Prevent the risk of becoming trapped in the scissor mechanism. Make sure the safety prop has been fitted before working, for example, on the scissor mechanism (e.g. lubricating the scissor mechanism).
- If the scissor lift was turned off during maintenance work and must remain turned off, take measures to prevent the scissor lift from unexpectedly or unintentionally being turned on. Make sure others cannot undo the measures that have been taken.
- Before cleaning the scissor lift with steam, water or other liquids, protect all the components that must not be exposed to liquids. Remove the protection after cleaning the scissor lift.
- Make sure oil, grease and other substances that are harmful to the environment are disposed of in a safe and environmentally-friendly manner.

2.2.4 Safety instructions when working on the electrical system

- Turn off the scissor lift before working on the electrical system.

2.2.5 Safety instructions when working on the hydraulic system

- Make sure the correct fire extinguisher is available. Leaking oil can be hot and may cause a fire.
- Lower the platform as far as possible before carrying out work on the hydraulic system.
- Remove the pressure before working on the hydraulic system.
- Do not touch the hydraulic system's lines. Leaking, hot oil can cause burns or penetrate the skin. If you come into contact with oil, immediately contact a doctor who has experience with this type of injury.

2.3 Liability

HOLLAND LIFT INTERNATIONAL B.V. cannot be held liable for:

- Damage resulting from negligent use and/or maintenance of the scissor lift.
- Any printing errors in the documentation or their consequences.



T-210DL25 4WD/P/N-EN Rev. 0

2.4 Users

- The management is obliged to instruct the users of the scissor lift in its use and maintenance with the aid of the instruction manual, additional instructions and directions.
- The instruction manual must be easily accessible to the user at all times in a tube that has been fitted in the scissor lift's valve/electrical box for that purpose. If necessary, **HOLLAND LIFT INTERNATIONAL B.V.** can provide a new copy of the instruction manual on request.
- The scissor lift may only be operated by people who are 18 years of age or older, who know how to operate the scissor lift and who have read and understood the operating instructions and regulations that are applicable to the **HOLLAND LIFT INTERNATIONAL B.V.** scissor lift.
- It is strictly forbidden for people to operate the scissor lift when they are under the influence of alcohol, drugs or medicine that makes them drowsy.
- In the Netherlands, operators are recommended to have the "Veiligheidscertificaat Hoogwerker". This is recognized by the Stichting Toezicht Certificatie Verticaal Transport (TCVT).
The IPAF Mobile Elevated Working Platforms Operator course is recognized internationally.
- Maintenance may only be carried out by people who have read and understood the instructions contained in the instruction manual and who have specific knowledge of the operation and construction of the scissor lift manufactured by **HOLLAND LIFT INTERNATIONAL B.V.**.

2.5 Intended use

- Only use the scissor lift for the intended use.
Also see 1.8.1.



T-210DL25 4WD/P/N-EN Rev. 0

2.6 Decalls on the scissor lift

2.6.1 Decalls on the front of the scissor lift

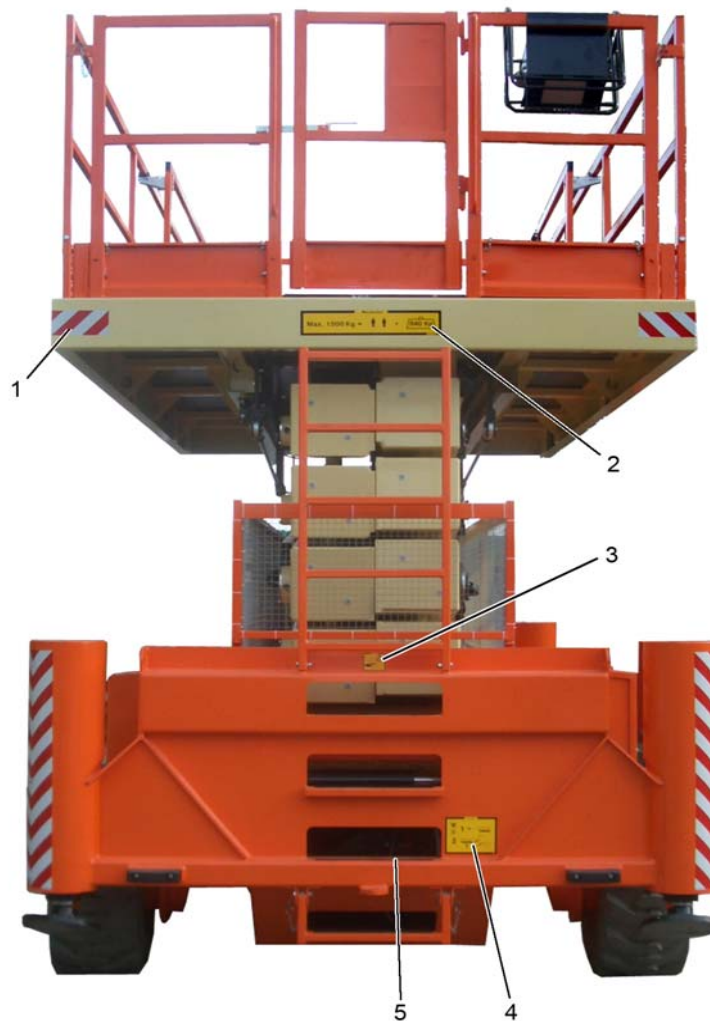

Front

1. Reflective material (on all the corners).
2. Max. 2 persons + load.
3. Risk of hands becoming trapped.
4. Emergency descent procedure.
5. Anti-slip material.



T-210DL25 4WD/P/N-EN Rev. 0

2.6.2 Decalls on the left-hand side of the scissor lift



1. Scissor lift type indication.
2. Main switch symbol.
3. Main switch text.
4. Not permitted to be in a danger zone.
5. Shell Tellus 32.
6. Hydraulic oil.
7. Inspection decall.
8. 230 V AC (optional).
9. Lubrication advice.
10. Reflective material (on all the corners).
11. Brand name.



T-210DL25 4WD/P/N-EN Rev. 0

2.6.3 Decalls on the right-hand side of the scissor lift



Right-hand side

1. Brand name.
2. Safety prop instructions.
3. Type indication.
4. Lubrication advice.
5. "DIESEL".
6. Fire risk.
7. Not permitted to be in a danger zone.
8. Reflective material (on all the corners).



T-210DL25 4WD/P/N-EN Rev. 0

2.6.4 Decalls on the control box and on the platform



Decalls on the inside of the platform

1. "Only lower the scissor lift when the platform has been retracted."
2. Concise operating instructions.
3. Reflective material on all the corners.
4. "230 V AC"



230 V AC decal on the socket (optional)



T-210DL25 4WD/P/N-EN Rev. 0

2.6.5 Decalls in the compartments for the hydraulic oil reservoir and the valves/electronics

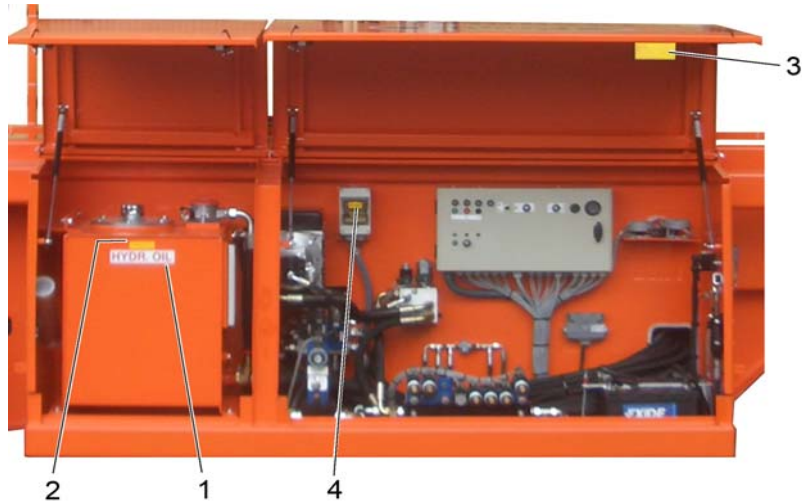

Hydraulic oil and valve/electrical compartment

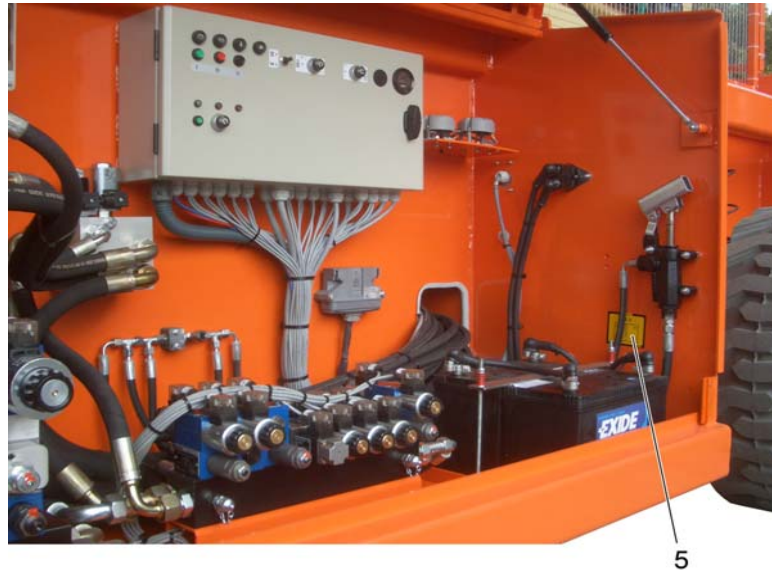

Valve and electrical compartment

1. "Hydraulic oil".
2. "Shell Tellus 32".
3. Extendable platform emergency procedure.
4. '230 V AC".
5. Battery terminal positions.



T-210DL25 4WD/P/N-EN Rev. 0

2.6.6 Decalls in the compartment for the diesel engine and the central grease lubrication system

The decall in the diesel engine compartment uses pictures to explain the maintenance instructions for the diesel engine. This decall uses pictures to explain the maintenance instructions for the diesel engine. There are a number of optional grease lubrication systems. Each system has its own decall.

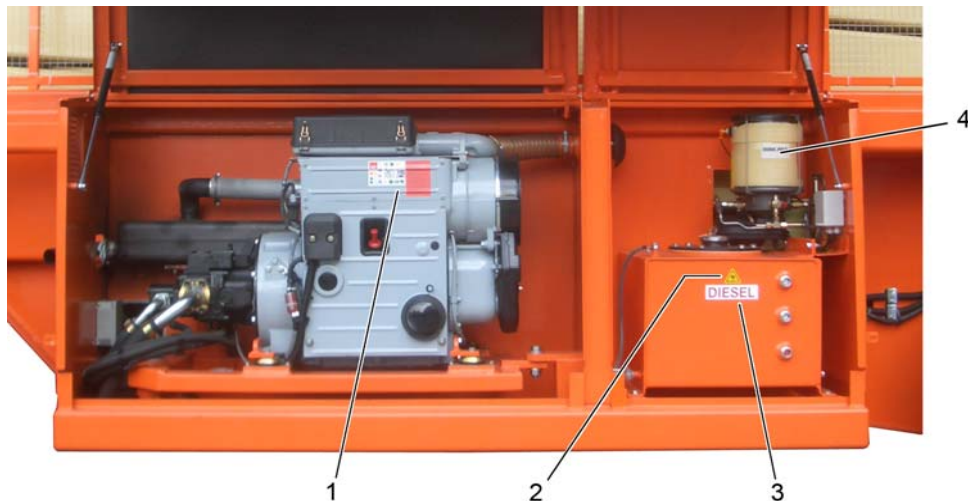

Diesel engine and central grease lubrication system compartments

1. Hatz maintenance instructions decall.
2. Fire risk.
3. "DIESEL".
4. Central grease lubrication system decall.

The Hatz maintenance instructions decall contains pictures for all the periodic maintenance instructions for the diesel engine. It also indicates the type of oil to be used.

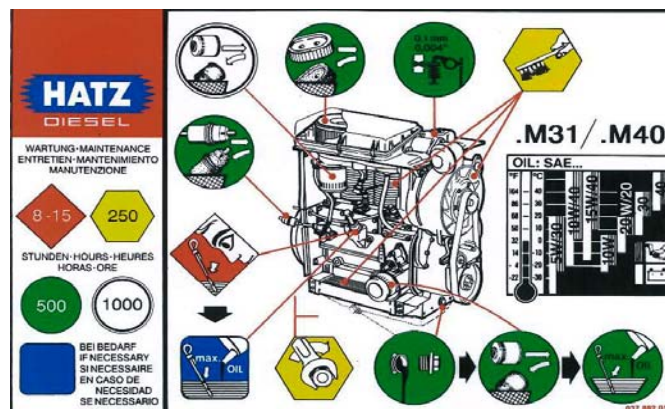

Maintenance instructions decall for the diesel engine

The decall for the Easy Lube Systems™ central grease lubrication system also contains a picture of the maximum and minimum levels for the grease reservoir.



T-210DL25 4WD/P/N-EN Rev. 0

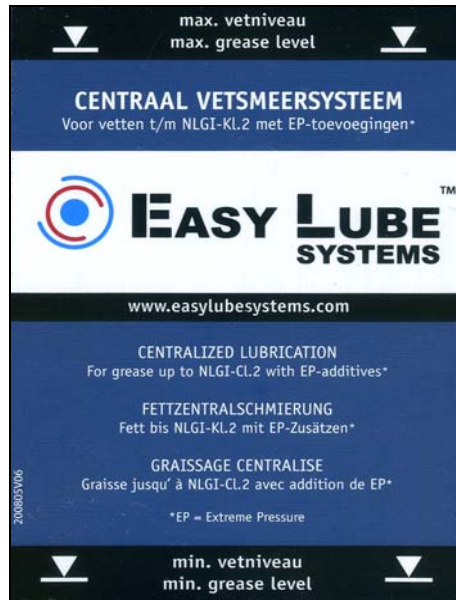

Decal for the Easy Lube Systems™ central grease lubrication system



T-210DL25 4WD/P/N-EN Rev. 0

2.7 Location of the safety devices on the scissor lift



Safety precautions

1. Emergency stop button.
2. Safety prop.
3. Driving alarm – visual (optional).
4. Protective scissor skirt.
5. Controlled one-way valves in self-levelling outriggers.
6. Oscillating axle lock / switch for the oscillating axle position detection.
7. Tilt indicators.
8. Driving alarm - acoustic.
9. Proximity switch – lifting cylinder.
10. Emergency descent valve.
11. Pipe/hose fracture safety device.
12. Limit switch – 4/8 metres.



T-210DL25 4WD/P/N-EN Rev. 0

2.7.1 Emergency stop button

The emergency stop button can be used to deactivate all of the scissor lift's functions.

- All of the functions are deactivated when the emergency stop button is pressed.
- If the emergency stop button is pulled out and rotated a quarter of a revolution clockwise, then all the functions will be activated again after 2 seconds.

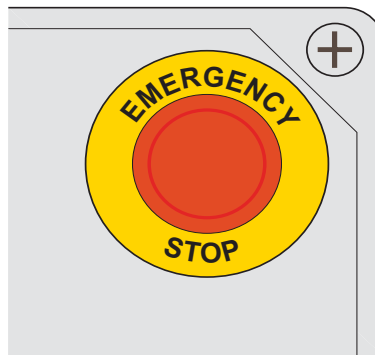

Emergency stop button

2.7.2 Safety prop

The safety prop prevents people from becoming trapped in the scissor mechanism when work must be carried out on it.

2.7.3 Protective scissor skirt

The protective scissor skirt prevents people from coming into contact with the scissor mechanism's moving parts.

2.7.4 Driving alarm - visual

The visual driving alarm is activated when the scissor lift is being driven. Two lights will flash when it is being driven.



Comment

Only for scissor lifts with the "visual driving alarm" option.



T-210DL25 4WD/P/N-EN Rev. 0

2.7.5 Emergency descent device

The emergency descent valve on the lifting cylinder allows the platform to be lowered in the event of an emergency.

This is possible by pulling the red operating button (3) on the emergency descent valve (2).

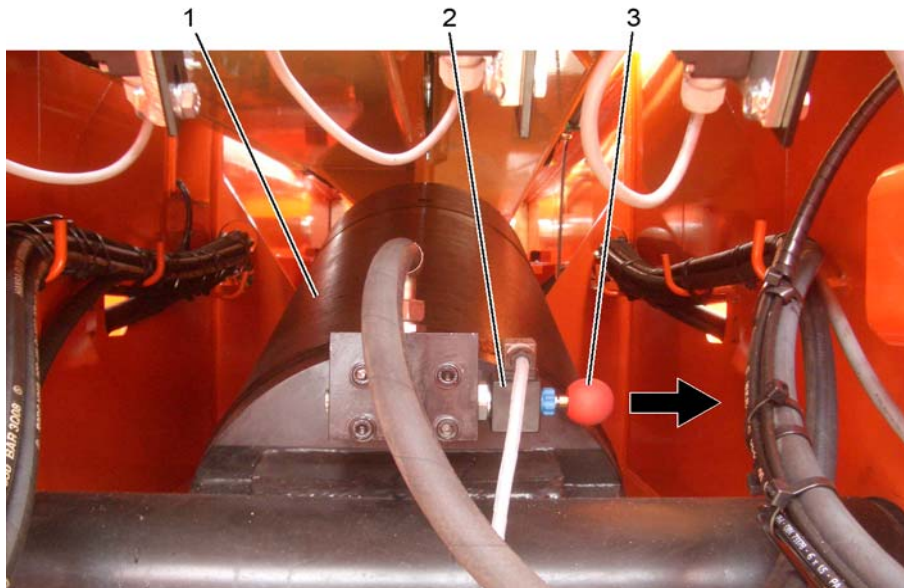

Emergency decent device

1. Lifting cylinder.
2. Emergency descent valve.
3. Operating button.

If, in this case, the platform is still in the extended position, then it must first be retracted using the hand pump (in the valve box). The hand pump's lever must be placed in the adaptor. The hand pump lever is located in the bottom of the valve and electrical compartment.



Hand pump for the extendable part of the platform



T-210DL25 4WD/P/N-EN Rev. 0

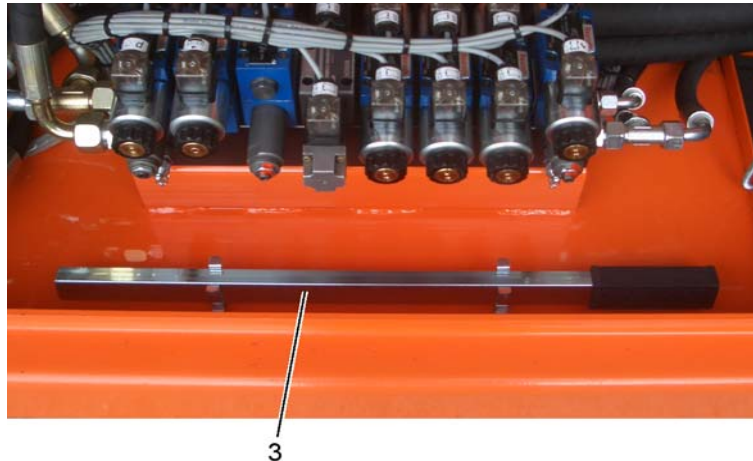

3
Hand pump lever

1. Hand pump.
2. Lever adaptor.
3. Hand pump lever.

2.7.6 Driving alarm – acoustic

The acoustic driving alarm sounds when the scissor lift is being driven: a warning signal will be heard.

2.7.7 Speed limiter

The speed limiter prevents the scissor lift from being driven too fast when the platform is raised.

- The slow driving speed is automatically activated when the platform is at a height of more than 4 metres. The fast driving speed is activated again once the platform is at a height of less than 4 metres.
- The driving and steering functions are automatically deactivated when the platform is at a height of more than 8 metres. The driving and steering functions can only be activated again once the platform is at a height of less than 8 metres.



Comments

Only for scissor lifts with the "Drive at full height" option.

- It is possible to reactivate the driving and steering functions when the platform is at a height of more than 8 metres by placing the key switch on the electronics box in the "1" position.



T-210DL25 4WD/P/N-EN Rev. 0

2.7.8 Tilt indicators

- If the scissor lift exceeds the specified maximum tilt when the platform is at a height of more than 4 metres, a warning signal will sound and all the movement functions will be deactivated, with the exception of the descent function and the retraction of the platform.



Tilt indicators

1. Indicator for 1 degree tilt in the longitudinal or crossways direction. (Optional for permitting driving when fully extended.)
2. Indicator for a tilt of 3 degrees in the longitudinal direction and for 2 degrees in the crossways direction.

2.7.9 Mechanical overload safety device

The overload safety device informs the operator when the platform is overloaded.

- If the permitted load is exceeded (between 100-110%), all of the scissor lift's movement functions will be deactivated. An acoustic signal will sound continuously and the overload light will be lit. The excess load must be removed if the overload safety device is activated. The scissor lift's movement functions will then be activated again. It is recommended to have communication resources in your possession when on the platform in case of emergencies.



T-210DL25 4WD/P/N-EN Rev. 0



One of the overload safety device levers with switch

1. Overload safety device levers.
2. Overload safety device switch.



T-210DL25 4WD/P/N-EN Rev. 0

2.7.10 Lifting cylinder safety device

- This safety device prevents the lifting cylinder from mechanically jamming. A proximity switch is activated by a switch cam just before the cylinder reaches its maximum range, so that the lifting cylinder stops in time.

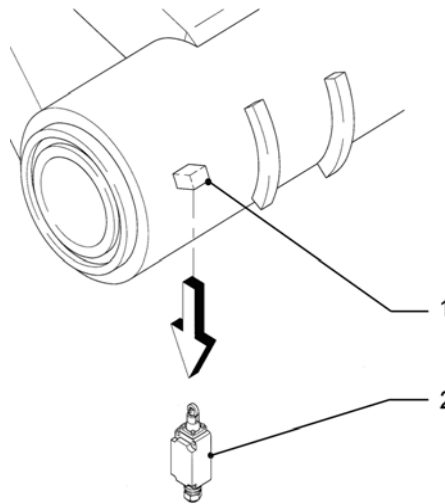

Lifting cylinder safety device

1. Switch cam.
2. Proximity switch.

2.7.11 Line/hose fracture safety device

An electronically controlled valve is fitted on the lifting cylinder. It is only possible to lower the platform with a control signal from the control box, even in the event of a line/hose fracture. The maximum descent speed is limited by a constriction in the cylinder.

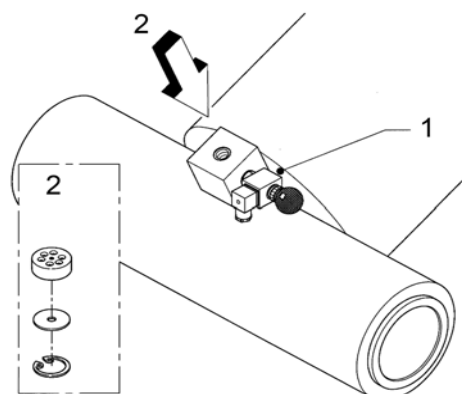

Line/hose fracture safety device

1. Descent valve with operating button.
2. Hose fracture safety device (constriction).



T-210DL25 4WD/P/N-EN Rev. 0

3 Controls



Overview of the controls

1. Control box.
2. Emergency stop button.
3. Connection for the control box.
4. Main switch.
5. Connection for the bottom carriage control box.



T-210DL25 4WD/P/N-EN Rev. 0

3.1 The control box

A plug-in connection makes it possible to use the control box both on the platform and on the bottom carriage.



A control box with 2 control panels



T-210DL25 4WD/P/N-EN Rev. 0

3.1.1 The main control panel

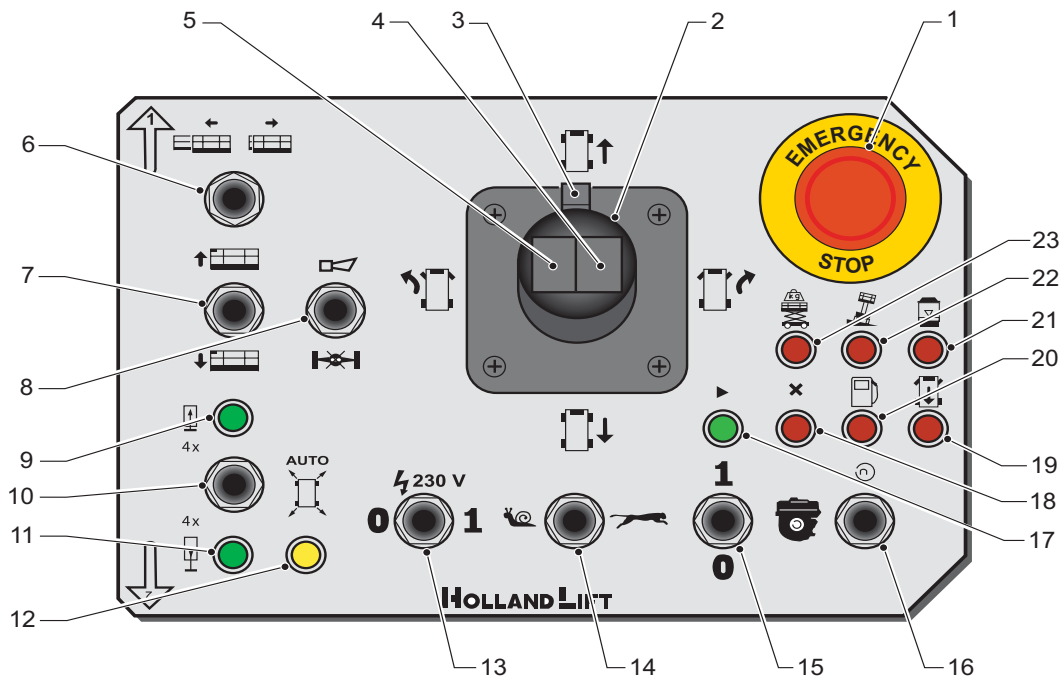

Main control panel

1. Emergency stop button.
2. Forwards/backwards control handle.
3. Dead man's switch.
4. Steer to the right.
5. Steer to the left.
6. Extend/retract platform.
7. Raise/Descend.
8. Horn/Locking function.
9. Outriggers retracted indicator light.
10. All outriggers in-out / Automatic levelling.
11. Outriggers extended indicator light.
12. Automatic leveling indicator light.
13. 230 V AC generator On/Off (optional).
14. Driving speed Fast/Slow.
15. Diesel engine On/Off.
16. Diesel engine speed Fast/Slow.
17. In operation indicator light.
18. Fault indicator light.
19. Oscillating axle
20. Fuel indicator light (optional).
21. Grease reservoir empty indicator light.
22. Tilt indicator light.
23. Overload indicator light.



T-210DL25 4WD/P/N-EN Rev. 0

3.1.2 Outriggers control panel

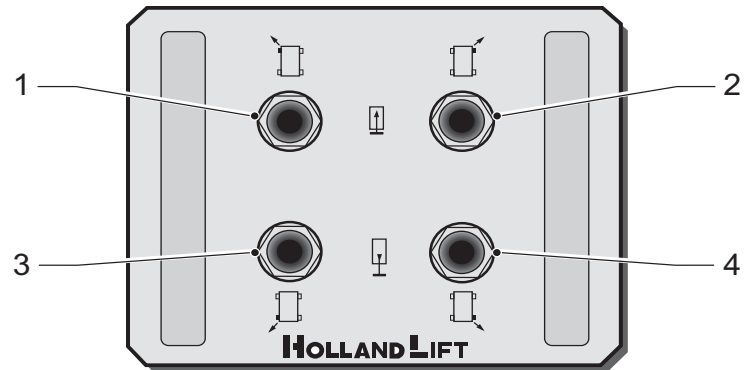

Outriggers control panel

1. Front left-hand outrigger.
2. Front right-hand outrigger.
3. Rear left-hand outrigger.
4. Rear right-hand outrigger.



T-210DL25 4WD/P/N-EN Rev. 0

4 Machine compartments

4.1 Hydraulic oil compartment

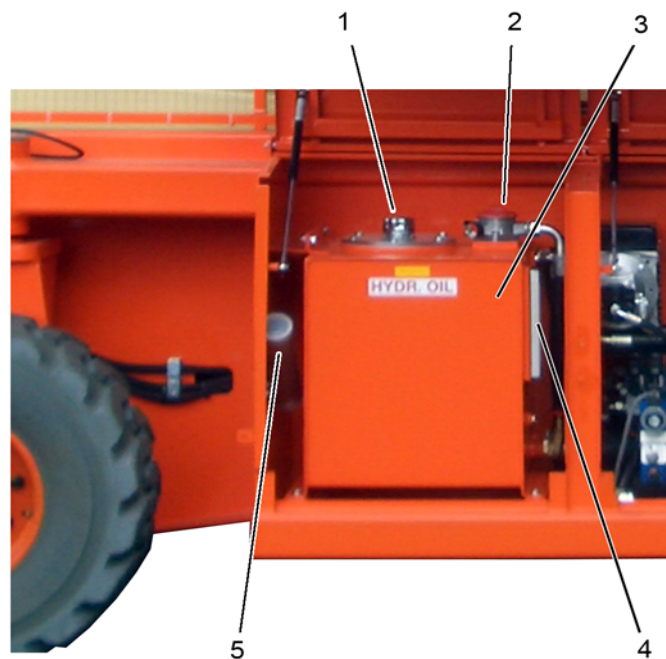

Hydraulic oil compartment

The hydraulic oil compartment is located on the left-hand side of the bottom carriage together with the valve and electrical compartment.

1. Hydraulic oil tank filler opening.
2. Filter element for hydraulic oil.
3. Hydraulic oil tank.
4. Gauge glass.
5. Document tube.



T-210DL25 4WD/P/N-EN Rev. 0

4.2 Valve and electrical compartment

The valve compartment and the electrical compartment together form a single unit.

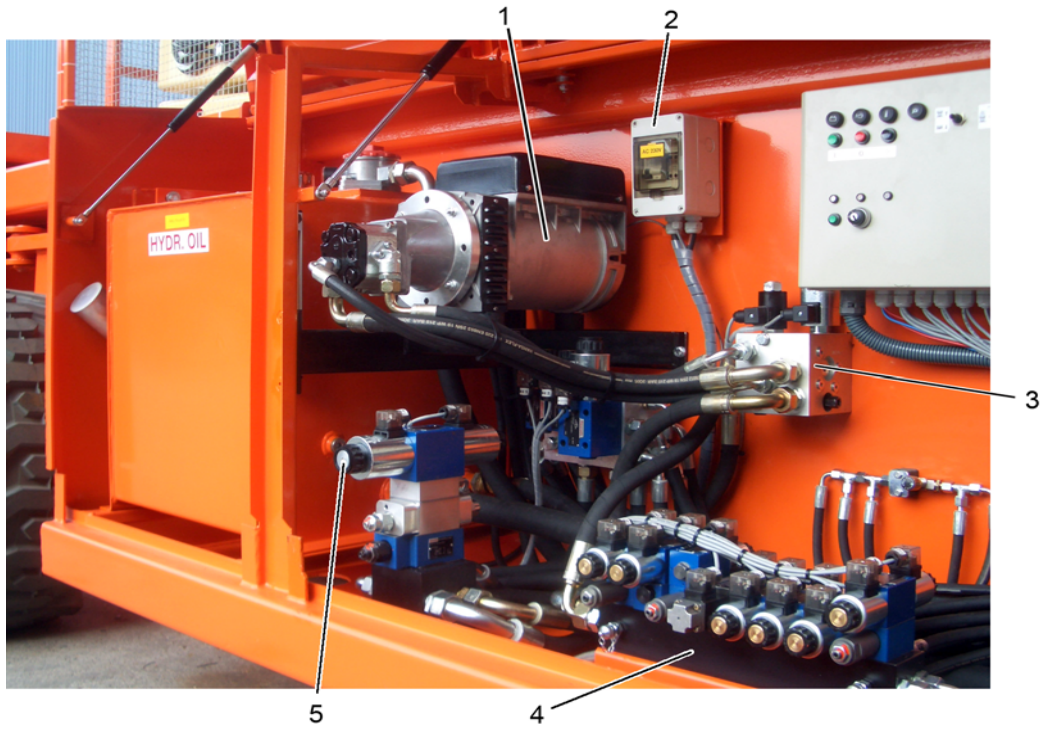

Valves and generator

1. Hydraulic electricity generator (optional).
2. 230 V automatic switch box (optional).
3. Generator valve block.
4. Valve block function.
5. Drive valve block.



T-210DL25 4WD/P/N-EN Rev. 0



Valves and generator

- 6. Electronics box.
- 7. Tilt indicators.
- 8. Main switch.
- 9. Emergency hand pump for the extendable platform.
- 10. Battery start.
- 11. Generator control.

4.3 Main switch

The main switch turns the power supply for the scissor lift on and off.

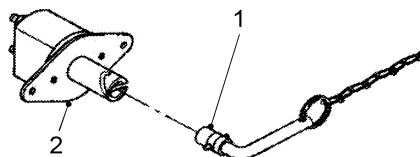

Main switch

- 1. Key with chain.
- 2. Main switch.



T-210DL25 4WD/P/N-EN Rev. 0

4.4 Electronics box

4.4.1 Control panel on the electronics box

The control panel contains a number of fault and indicator lights and buttons for the operating functions. They are intended for experts when carrying out maintenance work.

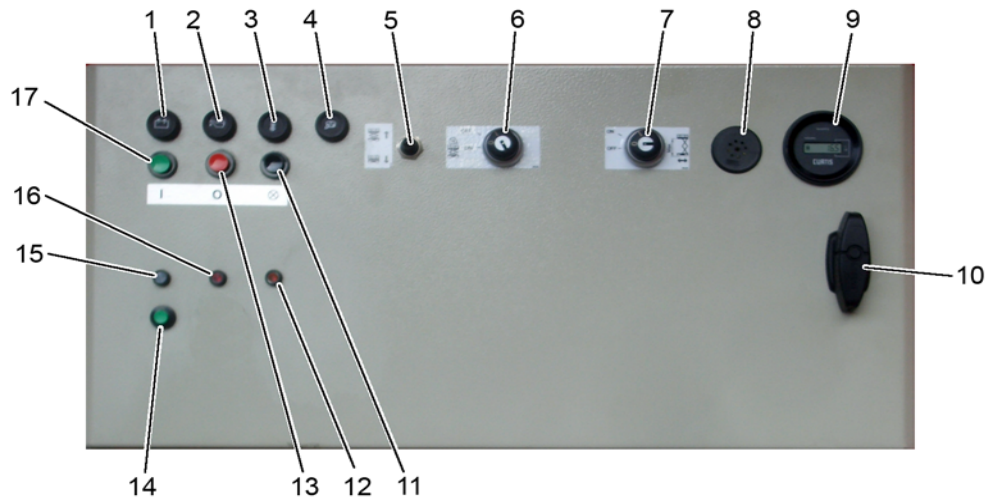

Control panel on the electronics box

1. Diesel engine charging current indicator light.
2. Engine oil pressure indicator light.
3. Engine temperature indicator light.
4. Diesel engine air filter indicator light.
5. Emergency switch for raising/descending.
6. Key switch for the overload safety device.
7. Key switch for driving when fully extended.
8. Horn.
9. Hour counter.
10. Locking button.
11. Test button for the indicator lights.
12. Scissor grease blockage fault (only for fully automatic grease lubrication system 54 lubrication points).
13. Diesel engine stop button.
14. Control button for the central grease lubrication system.
15. Grease pump indicator light (green/orange/red).
16. Bottom carriage grease blockage (only for fully automatic grease lubrication system 54 lubrication points).
17. Diesel engine start button.



T-210DL25 4WD/P/N-EN Rev. 0

4.4.2 Fuses

There are a number of important control current fuses in the electronics box.

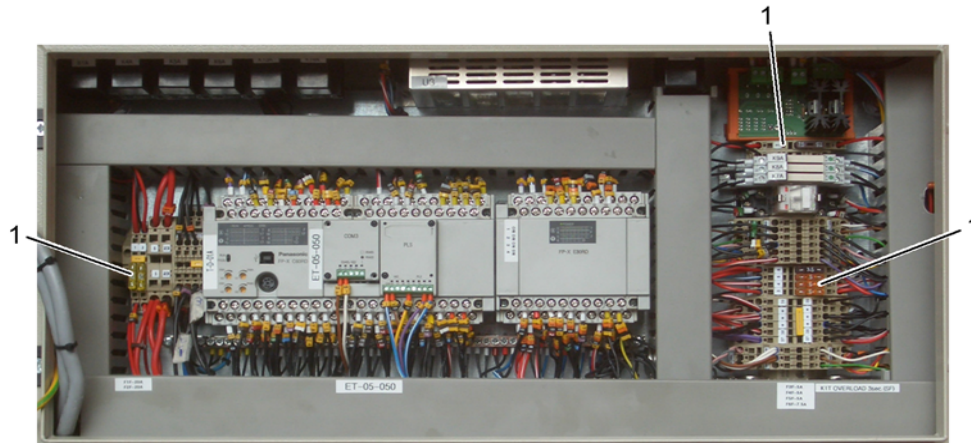

Opened electronics box

1. Control current fuses (see the electrical diagram).



T-210DL25 4WD/P/N-EN Rev. 0

4.5 Diesel engine and grease lubrication system compartment

4.6 Diesel engine compartment

The diesel engine compartment is located on the right-hand side of the bottom carriage. The HATZ diesel engine and the hydraulic pump that is connected to it are located in here. The unit is mounted on a rotating frame using vibration dampers. The frame is locked with a bolt.

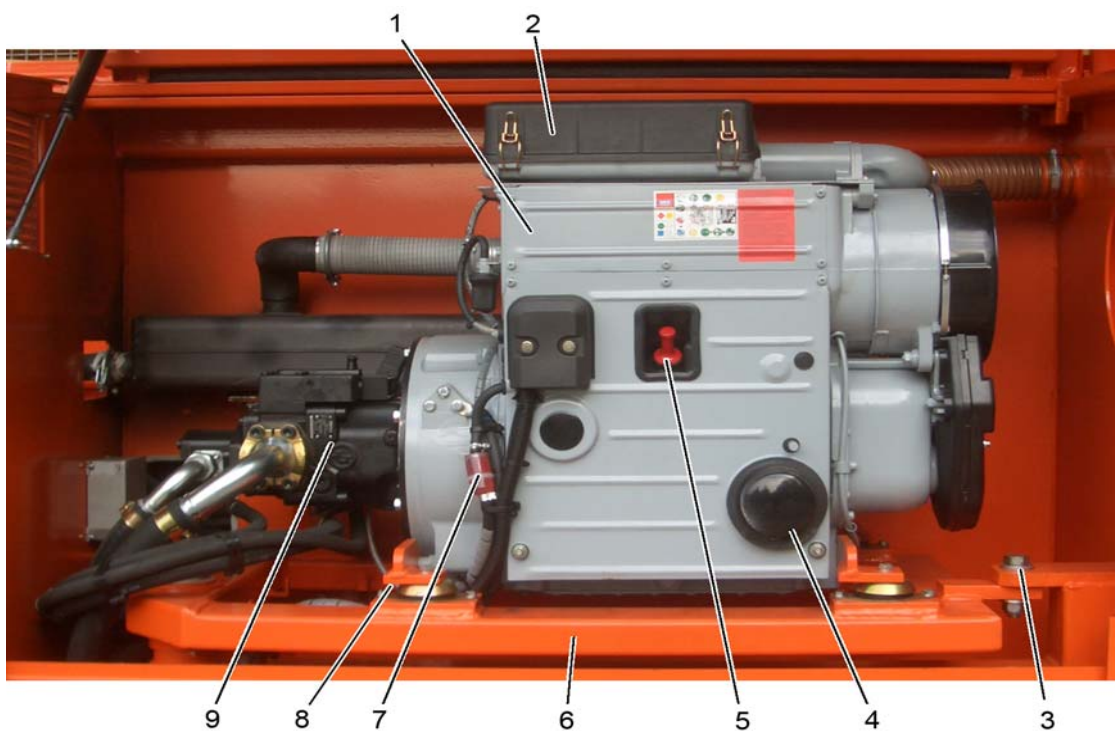

Diesel engine compartment

1. Diesel engine.
2. Air filter.
3. Lock bolt.
4. Engine oil filter.
5. Oil filler plug with dipstick.
6. Rotating frame.
7. Fuel filter.
8. Proximity switch (behind the rotating frame).
9. Hydraulic oil pump.



T-210DL25 4WD/P/N-EN Rev. 0

4.7 Fuel tank/grease lubrication system compartment

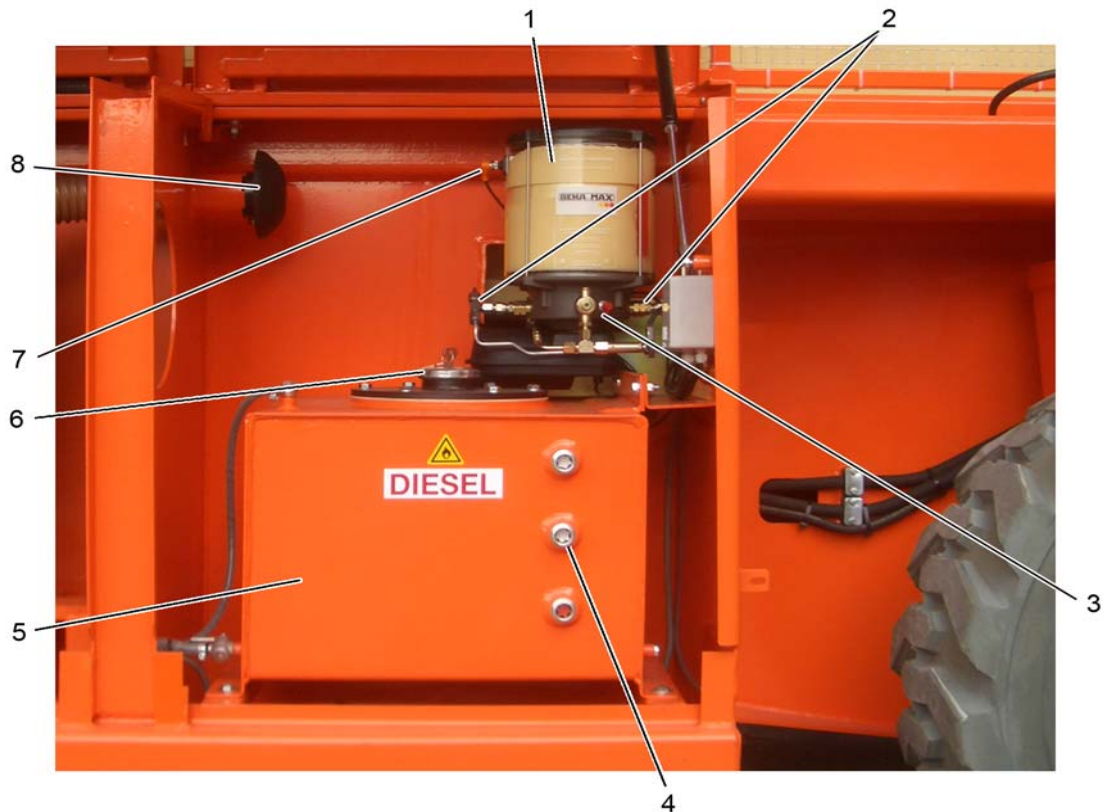

Fuel tank and grease compartment

1. Central grease lubrication system (optional).
2. Grease blockage sensors.
3. Grease filling nipple.
4. Gauge glass (x3).
5. Fuel tank.
6. Filler opening/sealing cap.
7. Empty sensor.
8. Diesel engine air intake.



T-210DL25 4WD/P/N-EN Rev. 0

5 Normal use

5.1 Preparations before use

- See the HATZ 3M41 diesel engine's instruction manual for instructions on how to prepare the engine.

5.2 Starting

- Insert the key (1) into the main switch.
- Rotate the key a quarter of a turn clockwise. The power for the scissor lift will now be turned on.

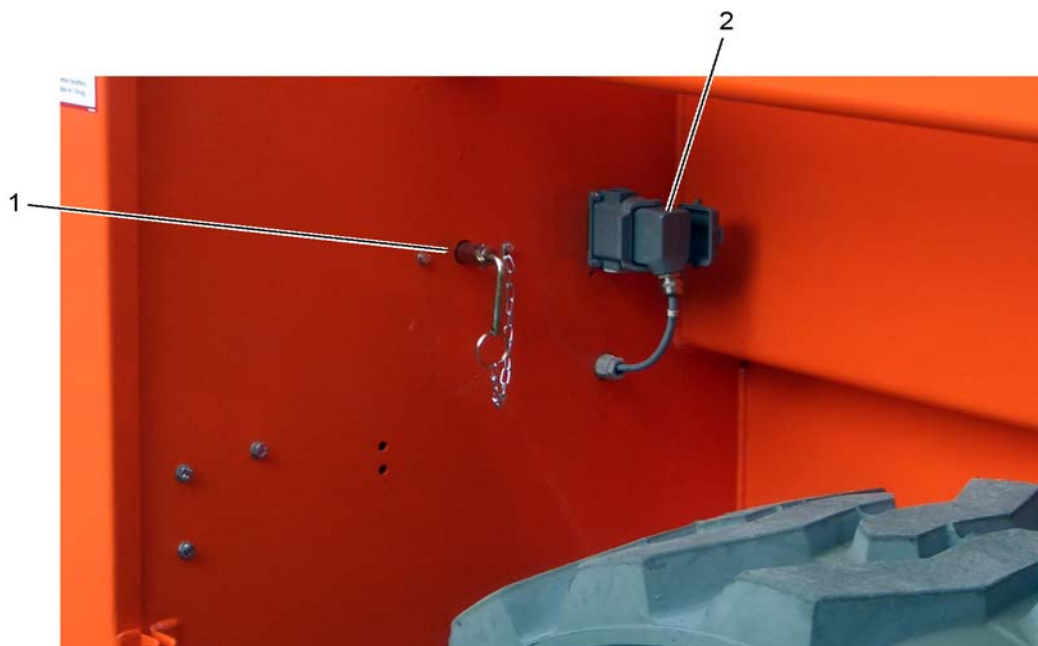

Main switch and key

- Key.
- Connecting plug.
- Access the platform via the steps.
- Erect the scissor skirt in the correct position and lock it correctly (see diagram).



T-210DL25 4WD/P/N-EN Rev. 0



Closed scissor skirt lock on the platform



Extendable platform scissor skirt lock

- E. Check whether the control box has been connected correctly and whether the connecting plug (2) on the bottom carriage has been inserted.
- F. Pull out and rotate the emergency stop button.
If the maximum permissible platform load has not been exceeded, then the scissor lift can be operated using the control box.



T-210DL25 4WD/P/N-EN Rev. 0

5.3 Turning off

1. Retract the platform and lock it.
2. Lower the platform.
3. Turn off the engine.
4. Press the emergency stop button.
5. Disconnect the control box and store it safely.
6. Rotate the key in the main switch a quarter of a turn anticlockwise.
7. Remove the key from the main switch.

5.4 Platform during transport

If the platform railings were folded down during transport, then it is necessary to make sure they are fitted correctly, including the locks, before the scissor lift is used again.



Note!

- Never use the scissor lift if the locks have not been fitted.
- The scissor skirt may never be removed when using the scissor lift.
- The extendable section must be fully retracted during transport.

5.5 Oscillating axle

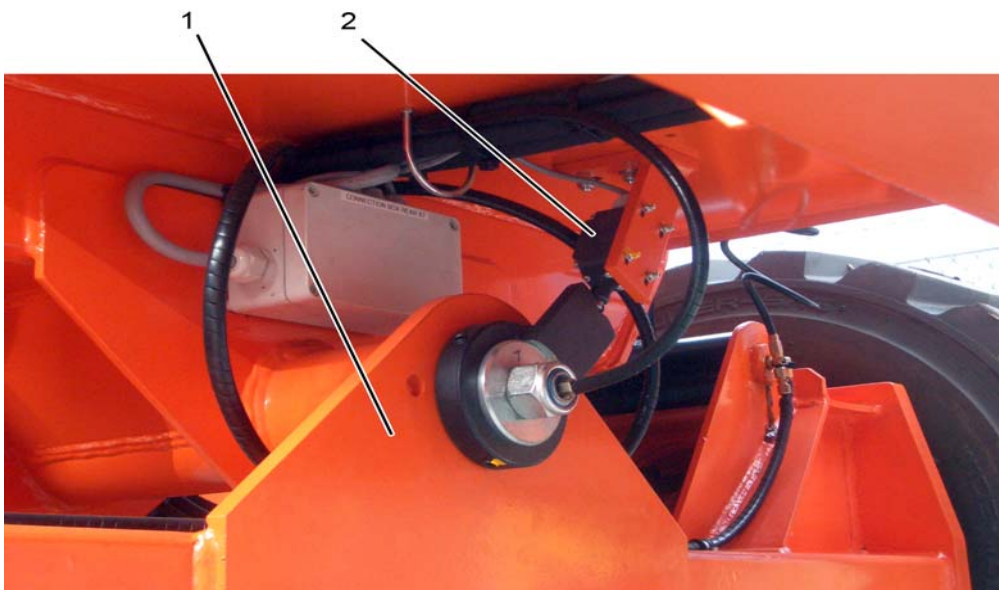

Switch for oscillating axle position detection

1. Oscillating axle.
2. Detection switch.



T-210DL25 4WD/P/N-EN Rev. 0

The scissor lift has an oscillating axle. This axle makes it possible to drive on an uneven surface with four driven wheels. It is only possible to drive the scissor lift whilst it is extended if the oscillating axle is in a horizontal position. The detection switch (2) detects this.

If the oscillating axle is not level and the platform is at a height of more than 4 metres, the function will be automatically deactivated. The fault indicator light on the control box will be lit. If the drive function is activated, the light will flash and an alarm will sound.

The scissor lift must be moved to a flat surface in order to put the oscillating axle in a horizontal position.

5.6 Automatically levelling the outriggers

The self-levelling outriggers can be used to level the scissor lift when it is on an uneven surface. The self-levelling outriggers can only be operated when the platform is at a height of less than 4 metres. It is not possible to drive the scissor lift when the outriggers are not fully retracted.

The "outriggers retracted" indicator light on the control box will then not be lit.

Push the switch forwards until the light is lit continuously and the safety device is deactivated.

The switch on the control box must be pushed backwards to extend the outriggers. Push the switch (10) until the "outriggers extended" indicator light (11) is lit continuously.

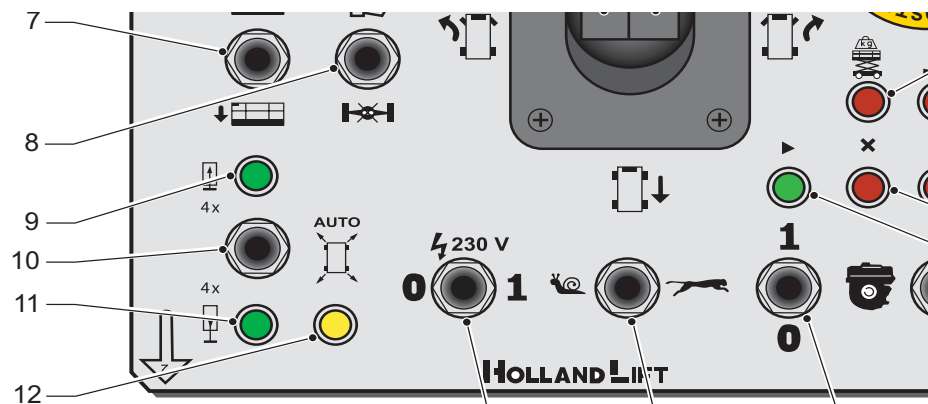

Control box

All 4 self-levelling outriggers will now be touching the ground. The scissor lift will be automatically levelled if the switch is kept pressed. This is indicated by the flashing "Automatic levelling" light (12). Press the switch until the light is lit continuously. The scissor lift is now level.



T-210DL25 4WD/P/N-EN Rev. 0

5.7 Central grease lubrication system (optional)

The scissor lift can have one of the two central grease lubrication systems listed below:

1. Easy Lube Systems™ central grease lubrication system (10 lubrication points).
2. Fully automatic central grease lubrication system (54 lubrication points).

5.7.1 Easy Lube Systems™ central grease lubrication system



Easy Lube Systems™ grease reservoir

Only a limited number of points are lubricated on machines with an Easy Lube Systems™ central grease lubrication system. A maximum of 10 lubrication points as indicated in the lubrication diagram (1 to 4 on page 43) are lubricated.

This means that the other lubrication points must be manually lubricated as explained in "Maintenance".

The grease reservoir has a capacity of 1.2 kg for EP NLGI-kl.2 + Teflon (< 2% dry material) grease. An empty reservoir is indicated on the control box by a flashing LED.

If the reservoir has not been topped up after a further 4 lubrication cycles, the lifting movement is blocked and the LED is lit continuously. The block on the lifting movement is removed once the reservoir has been topped up.

If a central grease lubrication system is fitted, there will be an extra button with a three-colour LED on the electronics box's control panel in the electrical compartment.

An extra lubrication cycle can be started by pressing the green button.

The functions of the three-colour LED are:

- Green: The grease pump is in operation.
- Orange: Empty reservoir during a lubrication cycle.
- Red: The reservoir is empty.



T-210DL25 4WD/P/N-EN Rev. 0

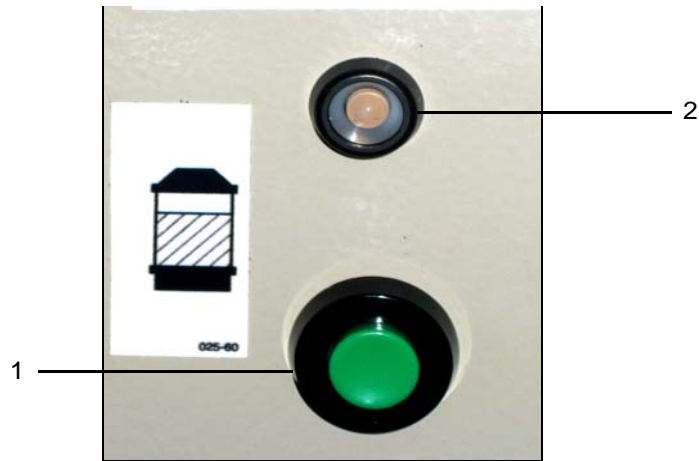

Control button and three-colour LED in the electrical compartment

1. Control button for the central grease lubrication system.
2. Three-colour LED.



Note!

Stop using the scissor lift if grease escapes from the pump's safety valve. Rectify the blockage in the central grease lubrication system before continuing to use the scissor lift.

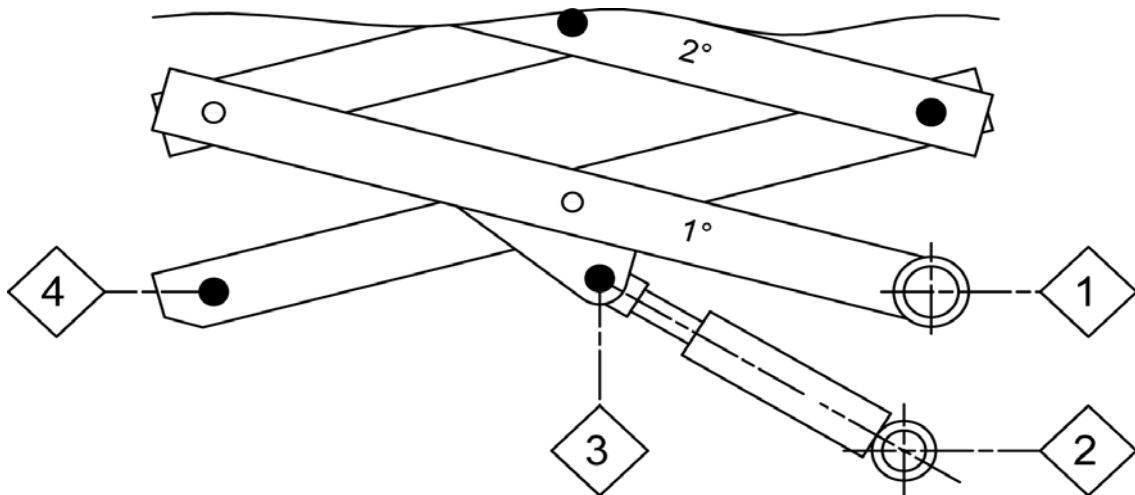

Lubrication diagram



T-210DL25 4WD/P/N-EN Rev. 0

6 Transport

6.1 Towing

6.1.1 Introduction

The scissor lift has multiple disc brakes with a towing function. The multiple disc brakes are applied when the scissor lift is stationary. The multiple disc brakes must be released before the scissor lift can be towed.



Releasing the multiple disc brakes

1. Plug.

6.1.2 Releasing the multiple disc brakes



Warning

Prevent the scissor lift from being able to roll away. For example, place chocks against the wheels.

- Use an Allen key (16 mm) to unscrew the plug (1). Remove the plug.
- Remove the central shaft.
- Reinsert the plug and tighten it.
- Repeat this for the other wheels.

The scissor lift can now be towed, because the wheels are no longer braked.



Warning

Restore the brakes for all the wheels after towing the scissor lift.



T-210DL25 4WD/P/N-EN Rev. 0

6.1.3 Point of special interest

When towing the scissor lift, pay attention to the following:

- The scissor lift may never be towed at a speed faster than the scissor lift's maximum speed.

6.2 Transport

6.2.1 Introduction

The towing eyes and the lashing/lifting eyes must be used when transporting the scissor lift. The towing eyes are located at the front and the rear of the scissor lift. The lashing/lifting eyes are located on the top corner points of the bottom carriage.

The following must be taken into consideration when using a different means of transport to move the scissor lift:

- If the scissor lift is hoisted onto another vehicle, then the lifting eyes, which are located on every corner of the bottom carriage, must be used.
- The weight of the scissor lift is stated on the type plate. Take this into consideration when deciding which means of transport or hoisting equipment to use.
- The bottom carriage must be secured to the means of transport in such a way that it cannot make any unintended movements in any direction. Use the lashing eyes for this.
- If the railings were folded away during transport, then they must be fitted properly again before using the scissor lift.

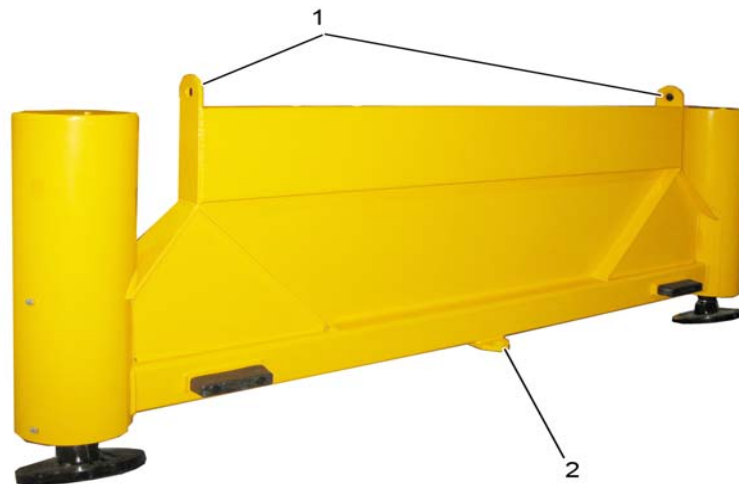

Lashing/lifting eyes and the towing eye

1. Lashing/lifting eyes.
2. Towing eye (at the front and rear).



T-210DL25 4WD/P/N-EN Rev. 0



Note!

Read the chapter entitled "Safety" for more information concerning safety issues when transporting the scissor lift.

Preparation

- Check the scissor lift's brakes.

6.2.2 Points of attention

When transporting the scissor lift, pay attention to the following:

- If the incline is steeper than 25 %, use a winch to drive the scissor lift onto the means of transport. Secure the winch to the towing eye on the bottom carriage.
- Only use the lashing/lifting eyes on the corners of the bottom carriage to hoist the scissor lift.



Comment

HOLLAND LIFT INTERNATIONAL B.V. does not recommend hoisting the scissor lift without using special hoisting equipment. If necessary, contact the manufacturer for more information.



T-210DL25 4WD/P/N-EN Rev. 0

7 Maintenance

7.1 Maintenance overview



Comment

The maintenance intervals given below are based on normal use of the scissor lift under normal conditions. If the scissor lift is subjected to extreme conditions (such as dust, algae, bacteria or salt deposits), the frequency must be increased. We reply on your responsibility and expertise.

Component	Action	Frequency
Scissor lift	Check the entire scissor lift for damage.	Every day
	Make sure the scissor lift works correctly.	Every day
	Make sure the safety devices work correctly.	Every day
	Make sure the decals are legible. If necessary, replace them.	Every day
	Lubricate the scissor lift according to the lubrication point overview.	Once a month
	Check all the bolt connections. If necessary, tighten them.	Once every 3 months
	Check the maximum permitted lifting pressure at the maximum working load and the maximum driving pressure. Contact the manufacturer if the measured maximum permitted lifting pressure is greater than the stated maximum driving pressure.	Once every 3 months
	Check all the sealed settings. Contact the manufacturer if any seals are broken.	Once every 3 months
Scissor mechanism	Have the scissor lift inspected by an expert.	Once a year
	Check the locks and attachments.	Once every 3 months
Lifting cylinder	Have the scissor mechanism inspected by an expert.	Every 5 years
	Check the locks and the attachments.	Once every 3 months
Hydraulic system	Check for damage and leaks. If necessary, rectify leaks and damage.	Every day
	Check the oil level. If necessary, top it up.	Every week
	Replace the filter element.	Once a year
	Change the oil.	Once a year
Diesel engine	Check the oil level. If necessary, top it up.	Every day
	Other: observe the instructions given on the Hatz maintenance decal.	See the decal



T-210DL25 4WD/P/N-EN Rev. 0

Component	Action	Frequency
Batteries	Check the fluid level. If necessary, top it up.	Every week
	Recharge the battery if the scissor lift has not been used for more than 2 weeks.	Every two weeks when not in use.
Proximity switches for the height stops	Check the operation and the setting.	Every week
Tilt safety device	Make sure it works correctly.	Every day
Wheels	Tighten the wheel bolts according to the tightening torque overview.	Once every 3 months
	Do not rest the wheels on the ground if the scissor lift is not going to be used for a long period of time.	-
PLC operation	Replace the battery. Only do so if the PLC is connected to a power supply, so that the program will be saved in the memory.	Every 4 years
Overload safety device	Make sure the scissor lift will not lift more than the specified work load.	Once a month
Easy Lube Systems™ central grease lubrication system	Check for leaks via the safety valve.	Every day
	Check the quantity of grease in the reservoir. If necessary, top it up. Next, press the green button for an extra lubrication cycle.	Once a month
Fully automatic central grease lubrication system (54 lubrication points).	Check for leaks via the safety valve.	Every day
	Check the quantity of grease in the reservoir. If necessary, top it up. Next, press the green button for an extra lubrication cycle.	Once a month

7.1.1 Protective scissor skirt

The protective scissor skirt on the bottom carriage prevents body parts from becoming trapped by the moving scissor arms.



Note!

If the scissor skirt is removed during maintenance work, then it must be put back correctly once the maintenance work has been completed.

It is not permitted to use the scissor lift if the protective scissor skirt has not been fitted or if it does not work as intended.



T-210DL25 4WD/P/N-EN Rev. 0



The protective skirt must be removed before lubrication.
Make sure the scissor skirt is properly put back before the scissor lift is used again.

7.2 Overviews

7.2.1 Lubrication points

If the scissor lift does not have a fully automatic central grease lubrication system, all the lubrication points must be lubricated with EP NLGI-kl.2 + Teflon® (< 2% dry material) at least once a month. The lubrication points are located in or on the following places:

- All of the scissor mechanism's hinged points.
- The shafts used to attach the scissor mechanism and the lifting cylinder to the bottom carriage (both sides).
- The swivel axles.
- The hinged points of the moving part and the fixed part of the oscillating axle.
- The outriggers plates' joints.
- The moving parts of the platform's extending mechanism.
- The rod system for the overload system.
- The access door.

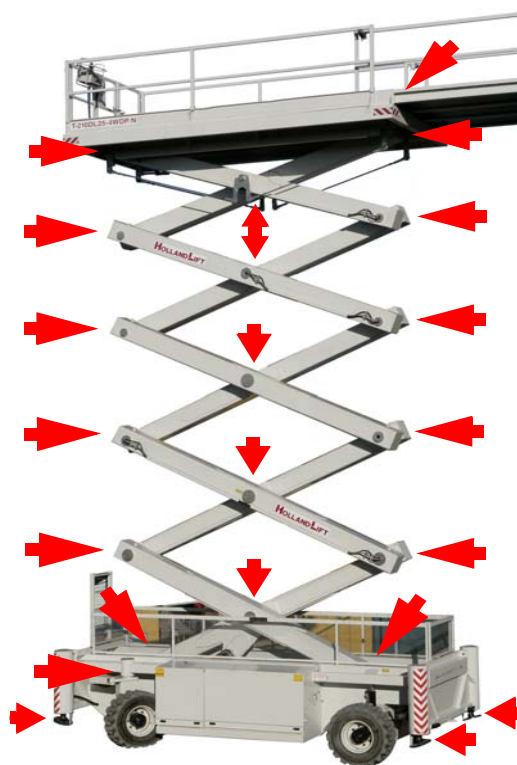

Lubrication points



T-210DL25 4WD/P/N-EN Rev. 0

7.2.2 Tightening torques

Bolt connection	Tightening torque
Swivel axle's drag rod	41 Nm
Control cylinder on the drag rod	41 Nm
Control cylinder on the bottom carriage	60 Nm
Control cylinder bracket on the bottom carriage	420 Nm
Wheel nuts	450 Nm
Gear casing on the swivel axles	210 Nm
Gear casing on the rear axle	210 Nm
Oscillating axle's shackle pin	240 Nm
Outriggers cylinder's assembly links	300 Nm

7.3 Maintenance procedures

7.3.1 Installing and removing the safety prop

Introduction

The safety prop prevents people from becoming trapped in the scissor mechanism when carrying out work on the scissor lift.



Safety prop

1. Safety prop.
2. Lock bolt.
3. Stop.
4. Axle stump.



T-210DL25 4WD/P/N-EN Rev. 0

Installing the safety prop

1. Make sure there is no load on the platform.
2. Make sure the scissor mechanism is opened far enough so that the safety prop (1) can be installed.
3. Remove the locking washer (2).
4. Rotate the safety prop a quarter of a turn upwards as far as the stop (3).
5. Lower the platform until the scissor axle stump (4) fall into the recess in the safety prop.

Removing the safety prop

1. Raise the scissor mechanism slightly so that the safety prop comes free.
2. Rotate the safety prop a quarter of a turn back into the rest position.
3. Use the lock bolt to lock the safety prop.

7.3.2 Topping up the hydraulic system



Note!

Only top up the hydraulic system with Shell Tellus T32.

- Fill the tank until the oil level reaches half the volume indicated on the gauge glass.

7.3.3 Lubrication



Note!

Only use EP NLGI-kl.2 + Teflon® (< 2% dry material) grease to lubricate the scissor lift. The warranty will no longer be valid if grease with a different composition is used.

1. Fit the safety prop.
2. Use the optional fully automatic grease lubrication system or manually spray the correct quantity of grease into all of the indicated lubrication points until plenty of greases escapes from behind the washers.
3. Carefully remove any excess grease.

7.3.4 Check the tilt safety device

- Press the edge of the tilt safety device from the top.
 - A warning signal will sound.

7.3.5 Inspecting the scissor mechanism

The scissor mechanism's hinged points must be checked for play, wear and damage by an expert every five years. A hinged point will be rejected if one or more of the following rejection criteria apply to the shaft or the bearing.

Rejection criteria:

- The shaft or the bearing has visible damage.
- The surface of the shaft or the bearing has a roughness greater than 1 µm.
- The shaft's layer of chrome is damaged.
- The depth of the bearing's grease chamber is less than 0.40 mm.
- The shaft or the bearing is not sufficiently lubricated.



T-210DL25 4WD/P/N-EN Rev. 0

- The shaft or the bearing have got stuck.
- The play between the shaft and the bearing is greater than the specified limit (see table).

Shaft diameter (mm)	Clearance F7 (μm)	Bearing - inner diameter (mm)	Clearance H9 (μm)
160 f7	-43 -83	160 H9	+100 0
140 f7	-43 -83	140 H9	+100 0
110 f7	-36 -71	110 H9	+87 0
90 f7	-36 -71	90 H9	+87 0
75 f7	-30 -60	75 H9	+74 0
65 f7	-30 -60	65 H9	+74 0
40 f7	-25 -30	40 H9	+62 0



T-210DL25 4WD/P/N-EN Rev. 0

8 Rectifying faults

Fault	Possible cause	Action
The scissor lift cannot be turned on.	The main switch has not been turned on.	Turn on the main switch.
	The emergency stop button has been pressed.	Pull out and rotate the emergency stop button and wait 10 seconds.
	There is a short circuit or a fuse has blown.	Trace the cause and replace the fuse.
The diesel engine runs, but the scissor lift does not work.	The hydraulic pump does not work, so the hydraulic system cannot build up any pressure.	Contact the technical services department.
	The oil level in the hydraulic system is too low.	Top up the hydraulic system.
	The hydraulic pump is broken.	Replace the hydraulic pump.
The scissor lift cannot be driven with a raised platform or the platform cannot be raised.	The maximum tilt has been exceeded and the tilt safety device has been activated.	Lower the platform and make sure the scissor lift is on a level surface.
The platform cannot be raised or lowered.	The platform has been overloaded and the overload safety device has been activated.	Reduce the load on the platform or follow the emergency descent procedure.
The scissor lift cannot be driven at a fast speed.	The platform is at a height of more than 4 metres.	Lower the platform to a height of less than 4 metres.
The scissor lift cannot be driven.	The platform is at a height of more than 8 metres.	Lower the platform to a height of less than 8 metres.
The platform cannot be lowered.	The safety prop is blocking the scissor mechanism.	Remove the safety prop.
	The electrical system has cut out.	Use the emergency descent valve to lower the platform and check the electrical system.
A fault cannot be rectified.		Contact the manufacturer (Holland Lift International B.V.).



T-210DL25 4WD/P/N-EN Rev. 0

9 Disposal

9.1 Introduction

The scissor lift must be disposed of in an environmentally-friendly manner. For example:

- Trade in the scissor lift when purchasing a new scissor lift.
- Dispose of the scissor lift at a specialist company.

9.2 Disposal procedure

1. Remove the batteries.
2. Remove the oil from the hydraulic system.
3. If necessary, remove the parts that can be reused.
4. Give the batteries, oil and the parts that cannot be reused to a specialist company.



T-210DL25 4WD/P/N-EN Rev. 0

10 Technical specifications

10.1 Technical specifications for T-210DL25 4WD/P/N

Use in enclosed spaces	No, unless the exhaust fumes are extracted.
Use outdoors	Yes
Max. wind speed	12.5 m/s
Working height	23 m
Max. platform height	21 m
Min. platform height	2.85 m
Platform dimensions (retracted)	5.22 x 2.40 m
Platform dimensions (extended)	7.32 x 2.40 m
Platform extension	2.10 m
Transport dimensions (l x w)	5.75 x 2.49 m
Transport height with railings	4.01 m
Transport height with handrail folded away	3.10 m
Wheelbase	3.76 m
Ground clearance (middle)	290 mm
Turning circle (external)	6.98 m
Terrain tyres (Solideal)	14 x 17.5
Power source	HATZ® 3M41 Diesel
Max. load with retracted platform	1,000 kg (4 people + 680 kg)
Max. load with extended platform	1,000 kg (4 people + 680 kg)
Raising/descent time (max. load)	Approx. 120 105 sec.
Driving speed (fast)	2.5 km/h
Driving speed (slow)	0.5 km/h
Maximum incline (platform lowered)	Approx. 25%
Max. longitudinal/crossways tilt	3° / 2° (mobile up to 8 metres, select position "0")
Max. longitudinal/crossways tilt	1° / 1° (mobile up to 16.5 metres, select position "1")
Own weight	17,950 kg
Max. wheel pressure (at max. tilt and max. height)	12,600 kg (11.6 kg/cm ²)
Max. outriggers pressure	16.9 kg/cm ² (Ø 290 mm)
Max. outriggers plate pressure	7.0 kg/cm ² (400 x 400 mm)
Max. towing speed	2.5 km/h (0.69 m/s)