



0 ▶▶ Introduction ◀◀

Thank you for the trust you have showed us buying a C.M.C. mobile elevating work platform (MEWP). We are sure you will be pleased with your choice.

0.1 ▶ Content of the manual ◀







This manual contains the technical specifications and the instructions for transfer, use and maintenance of the MEWP. While drawing up this manual, we took into consideration all the operations that are part of a normal use and a regular maintenance of the machine. So, for a correct and optimum use, you must follow the described instructions carefully.

This manual has been drawn up in order to:

- ❑ Show the technical features of the machine;
- ❑ Describe the control stations and their commands;
- ❑ Provide with the instructions for the transport, placement and use of the machine;
- ❑ Describe the safety devices;
- ❑ Point out the potential risks and/or possible dangerous situations;
- ❑ Provide with the necessary instructions for the ordinary maintenance operations;
- ❑ Provide with the instructions for the filling of the check register.

📖 THE USE AND MAINTENANCE MANUAL IS CONSIDERABLE AS A PART OF THE MACHINE. In case of sale of the MEWP, please give this manual to the new owner.

KEY FOR THE SYMBOLS USED IN THIS MANUAL:

	(CAUTION)	= warns the user about the risk of serious damages to people or to part of the equipment or the machine, if you do not obey the safety regulations.
	(WARNING)	= notifies the possibility of minor injuries to people or little damages to the platform or machine parts.
	(FORBIDDEN)	= prohibition signal
	(OBLIGATION)	= obligation signal
	(CAUTION)	= warns the user about the risk of environmental pollution.
*	(OPTIONAL)	= indicates an optional outfit.
	(IMPORTANT NOTE)	= indicates information and suggestions useful to work with the MEWP.

- ➔ This manual is addressed to:
- **users:** operators, ground assistants, guard staff, safety manager, service manager;
 - **manufacturers, dealers, owners, lessors or lessee, brokers.**



0.2 ▶ Disclaimer ◀

C.M.C. declines all responsibility in case of partial or total non-observance of the following instructions

- ➔ Before any operation of use of the machine, the user is obliged to carefully read the text of this manual, with reference to sections relative to specific work activity to perform.
- ➔ The use of the machine must be entrusted only to trained and authorized staff. This manual cannot replace in any way a suitable experience that the staff in charge must have gained previously on similar machines or that they will be able to get on this machine, under the guidance of an already trained staff.
- ➔ The user must work within the functional limits of the machine and perform a constant and diligent maintenance, using only original spare parts indicated by C.M.C.
- ➔ The operator shall carefully know the safety standards foreseen by national and international legislations and apply them during all operations with the MEWP.

☞ **The guarantee of proper functioning and full compliance of the machine with the intended service is strictly dependent on the correct application of all the instructions contained in this manual.**

☞ **The non-compliance with the previous items automatically invalidates the warranty.**

0.3 ▶ Where and how to store the manual ◀

- ➔ **The manual must be stored and kept in the best possible condition (away from sunlight), in a suitable place, for the purpose of always being available for consultation.**
- ➔ **This manual (or its copy) must always be on the machine** (in a case near the turret) for an immediate consultation by the operator during working operations.

- ➔ **Another copy shall be held by the basket operator during the working period inside the internal documents case.**
- ➔ **In case of loss or deterioration, the replacement documentation must be requested to C.M.C. s.r.l, citing the code of this manual.**

0.4 ▶ Regulatory references ◀



This manual has been drawn up according to the following national and international laws and directives:

Directive 2006/42/CE	ISO 3864	EN 280:2015
Directive 93/68/CEE	ISO 4302	EN 349
ISO 12100	ISO 4305	EN 60068-2-64
ISO 13849-1-2	ISO 4309	EN 60204-1-32
ISO 13850-13854	ISO 20381	EN 60529
ISO 13857	EN 13001	EN 62061
ANSI/SAIA A92.20-2018	ANSI/SAIA A92.24-2018	ANSI 92.6-2006
ANSI/SAIA A92.22-2018	ANSI Z359.1	CSA 354.1-2006



0.5 ▶ Amendments and integrations ◀

The information and legislative references present in this manual are those in force when the machine has been placed on the market.

Due to the constant and continuous improvement of their product by the manufacturers, the supplied machine could present some technical specifications different from those described on this manual. Any change will be however accompanied with specific documents attached explaining functional characteristics. In case of differences in comparison with the basic contents of this manual, the user is kindly asked to contact C.M.C. to receive supplementary technical specifications.

As this manual includes both current and optional components, you could find information not applicable to your machine.

C.M.C. reserves the right to update its production and its instruction manuals (without prior notice) according to the development of the technique, to the acquisition of new experiences and/or the change of law provisions, without being anyway obliged to intervene on the previously sold machines and on their manuals.

No part of this publication can be translated, modified or reproduced (even partially) without the expressed authorization of C.M.C. s.r.l.

C.M.C. reserves the right to modify - totally or partially - any data or specification of this publication (without prior notice).

Data and references indicated in this manual are those in force at the time of printing.

Year 2019
C.M.C. s.r.l.



1 ►► Specifications ◀◀

1.1 ► Technical sheet ◀

PERFORMANCE

Max. working height	14,90 m	48.89 ft
Max. work outreach	6,90 m	22.64 ft
Max. load on the basket	200 kg (USA)	441 lb. (USA)
Jib movement	90°	
Turret rotation	+/-178° (356° non-continuous)	
Basket rotation	NO	
(P) Max. slope to stabilize	8° / 14%	
(W) Max. ramp attack slope	16° / 29% (with jib closed) 30° / 58% (with jib lifted and on engine side)	
(X) Max. slope to travel	14° / 25%	
Travel speed	0,4 - 1,9 km/h	0.25 - 1.18 mph

DIMENSIONS

(A) Basket height	1,10 m	3.61 ft
(B) Basket width	0,60/0,70 m	1.97/2.30 ft
Basket length	0,80/1,20/1,40 m	2.62/3.94/4.59 ft
(D) Total length	4,13 m	13.55 ft
(E) Length without basket	3,39 m	11.12 ft
(F) Height in driving position	1,98 m	6.50 ft
(G) Total width (without basket)	0,77 m	2.53 ft
(H) Clearance from the ground in transport position	0,29 m	0.95 ft
Tracks (l x w x h)	1,21 x 0,18 x 0,36 m	3.97 x 0.59 ft x 1.18 ft
Tracks enlargement (*optional)	0,77/1,17 m	2.53/3.84 ft

(J) Max. longitudinal stabilization	2,70 m	8.86 ft
(K) Max. cross stabilization	2,70 m	8.86 ft
Outriggers plate Ø	0,18 m	0.59 ft

WEIGHT AND PRESSURES

Total weight (standard equipment)	1920 kg	4233 lb.
(R) Max. pressure on the foot	4,54 Kg/cm ² (44,46 N/cm ²)	64.57 lb./in ²
(S) Max. pressure on the track	0,21 Kg/cm ² (2,03 N/cm ²)	2.99 lb./in ²
(T) Max. pressure in travel	312 Kg/m ² (3,06 KN/m ²)	1523 lb./ft ²
(U) Max. pressure in work	246 Kg/m ² (2,42 KN/m ²)	1201 lb./ft ²

POWERS

Standard hydraulic feed	1) Honda GX390 benzina, 8.7 kW (11.7 HP), 3600 rpm
*Optional hydraulic feed	2) Honda iGX390 benzina, 8.7 kW (11.7 HP), 3600 rpm 3) Yanmar L100V diesel, 6.8 kW (9.1 HP), 3600 rpm 4) Kubota Z482-E4B diesel, 9.9 kW (13.3 HP), 3600 rpm 5) Electric engine 230 V - 2,2 Kw (EU) / 110 V - 2,2 Kw (UK) / 120 V - 1,6 Kw (USA) 6) Electric engine G0901306, 5.5 kW, 48 V, with lithium battery pack 160 Ah
Fuel tank capacity	6,1/15 l



Max allowed speeds according to USA/EU standards	
Max allowed lifting and descending speed of the MEWP	0,4 m/s (1.31 ft/s)
Max allowed boom extension and withdrawal speed	0,4 m/s (1.31 ft/s)
Max allowed rotation speed	0,7 m/s (2.3 ft/s)
Max allowed manual force in the basket with 1 operator	400 N

		Tightening torque
Bolts of the bearing	M16 cl 10.9	28 daNm

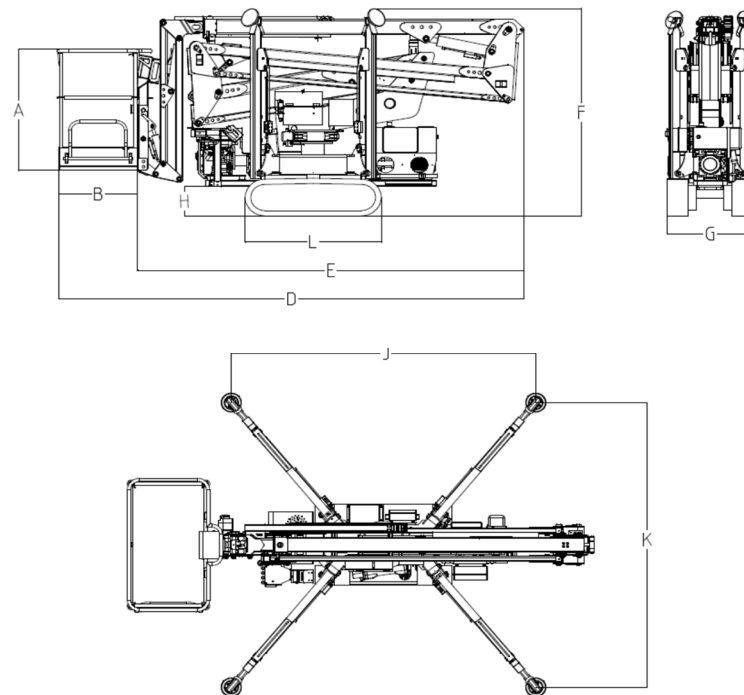
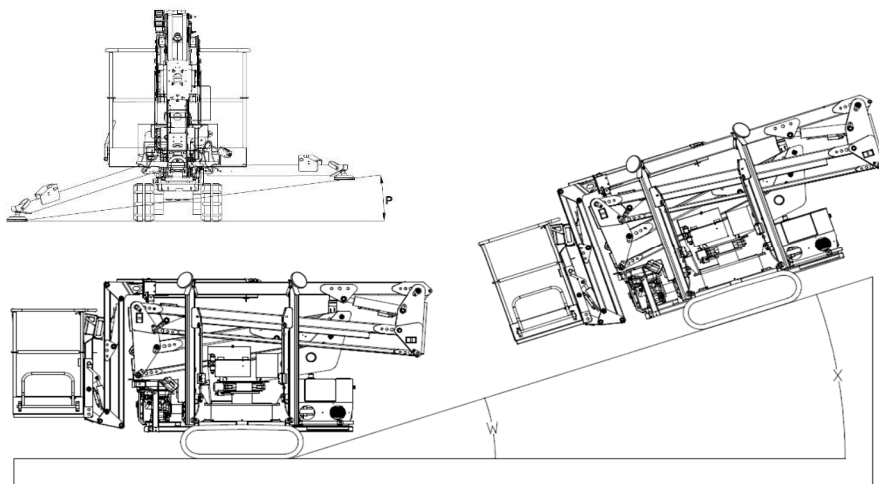

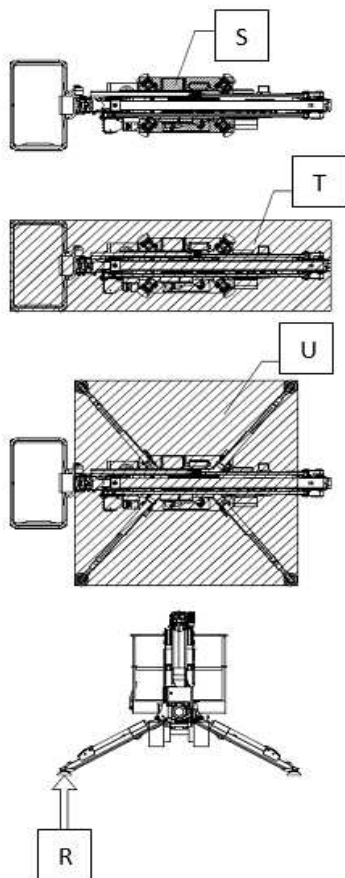



1.2 Identification plate

On the MEWP turret, there is a plate with all the identification data of the machine:



C.M.C. s.r.l.
Via Bitritto, 119
70124 BARI - ITALY
Tel. 080 5326606/557
<http://www.cmclift.com>
E-mail: info@cmclift.com

TYPE	S15	MANUFACTURER	CMC
MODEL	S15	YEAR	2020
SERIAL NR.	S19A2138	TOT. WEIGHT	4189 lbs
CAPACITY	441 lbs	INCLUDING	2 persons
MAX HYDRAULIC OPERATING PRESSURE		3336 PSI	
MAX MANUAL HORIZONTAL FORCE ALLOWED		90 lbs	
MAX WIND SPEED ALLOWED		28 mph	
MAX FRAME INCLINATION ALLOWED		1°	
EXTERNAL POWER SOURCE		120 V	60 Hz

Picture 1: identification plate.



1.3 ▶ CE certification ◀

C.M.C. s.r.l. states under its own responsibility that **S15** was designed and produced in compliance with national and European standards, and that the machine is identical to the model submitted to control and test for the “CE certification” by the Notified Institute **nr. 1878 - VERICERT s.r.l. - via L. Masotti, 5 - 48124 Ravenna - Italy.**

1.4 ▶ TÜV certification ◀

C.M.C. s.r.l. states under its own responsibility that **S15** was designed and produced in compliance with US standards ANSI/SAIA A92.20:2018 and that the machine is identical to the model submitted to control and test for the “TÜV certification” by **TÜV SÜD America Inc.**
TÜV SUD America Inc. is an OSHA recognized NRTL and a Standards Council of Canada accredited certification body.

1.5 ▶ Classification ◀

The mobile elevating work platform (MEWP) **S15** belongs to **group B**: the vertical projection of the center of the area of the MEWP in different platform configurations specified by the manufacturer can be outside the tipping lines (EN 280 par. 1.4 - ANSI/SAIA A92.20 par. 3).
As for the displacement, it belongs to **type 1**: travelling is only allowed with the MEWP in its transport configuration or in the stowed position (EN 280 par. 1.4 - ANSI/SAIA A92.20 par. 3).

1.6 ▶ Loading cycles ◀

The machine is expected to live for 40.000 working cycles¹ (i.e. 10 years, 40 weeks per year, 20 hours per week, 5 cycles per hour).
Within this term, the machine must undergo at least 2 (two) in-depth checks (structural, mechanical, electric, elements, etc.), **in case of heavy uses** (frequent use at the performance limit, unfavourable environmental conditions such as steel systems, paper mills and so on) **it is better to increase the checks.** Anyway, **it is advisable to have the state of the machine checked by the manufacturer factory or by an authorized assistance point, at least every 1500 – 2000 working hours or once a year.**

¹Loading cycle: cycle starts from the access position, continues performing the work and finishes returning to the access position.

1.7 ▶ Working diagram ◀

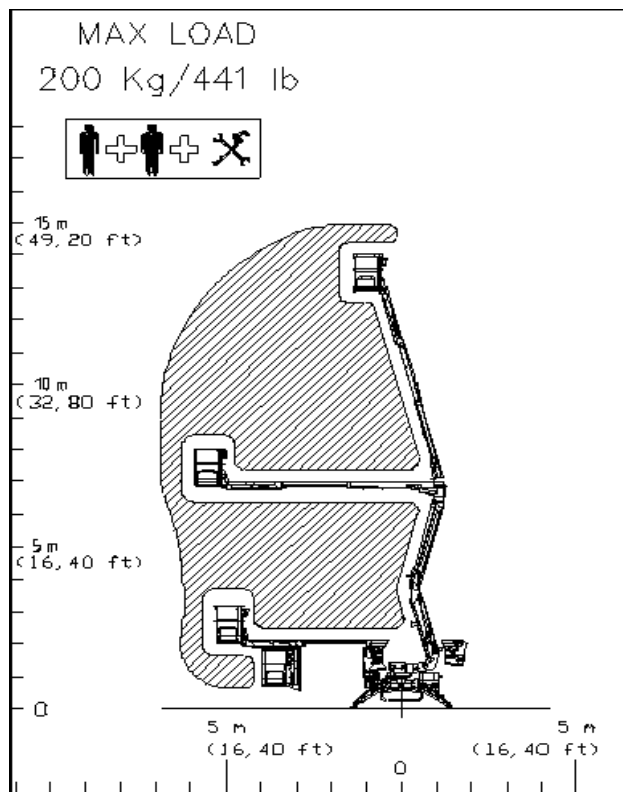

Picture 2a: working diagram with maximum load 200 kg/441 lb (valid only in the working area set by the outriggers placement).



2 ▶▶ Description and purpose ◀◀

2.1 ▶ Definition ◀

The machine is called S15 and it is a mobile elevating work platform (MEWP):

- machine/device intended for moving persons, tools and material to working positions, consisting of at least a work platform with controls, an extending structure and a chassis (ANSI/SAIA 92.20 par. 3);
- mobile machine intended to move persons to working positions, where they are carrying out work from the work platform, with the intention that persons are getting on and off the MEWP only at access positions at ground level or on the chassis and which consists as a minimum of a work platform with controls, an extending structure and a chassis (EN 280 par. 3.1).



It is forbidden to access to or exit from the work platform at different levels.

2.2 ▶ Machine purpose ◀

The MEWP **S15** is a machine which enables the operators to reach the working place when this is high-positioned.

The machine has been designed for an essentially vertical use. It must be transported only when it is totally folded in the transport position.

→ The use of the machine is allowed only to professional staff, properly trained and specialized.

2.3 ▶ Description of the main components ◀

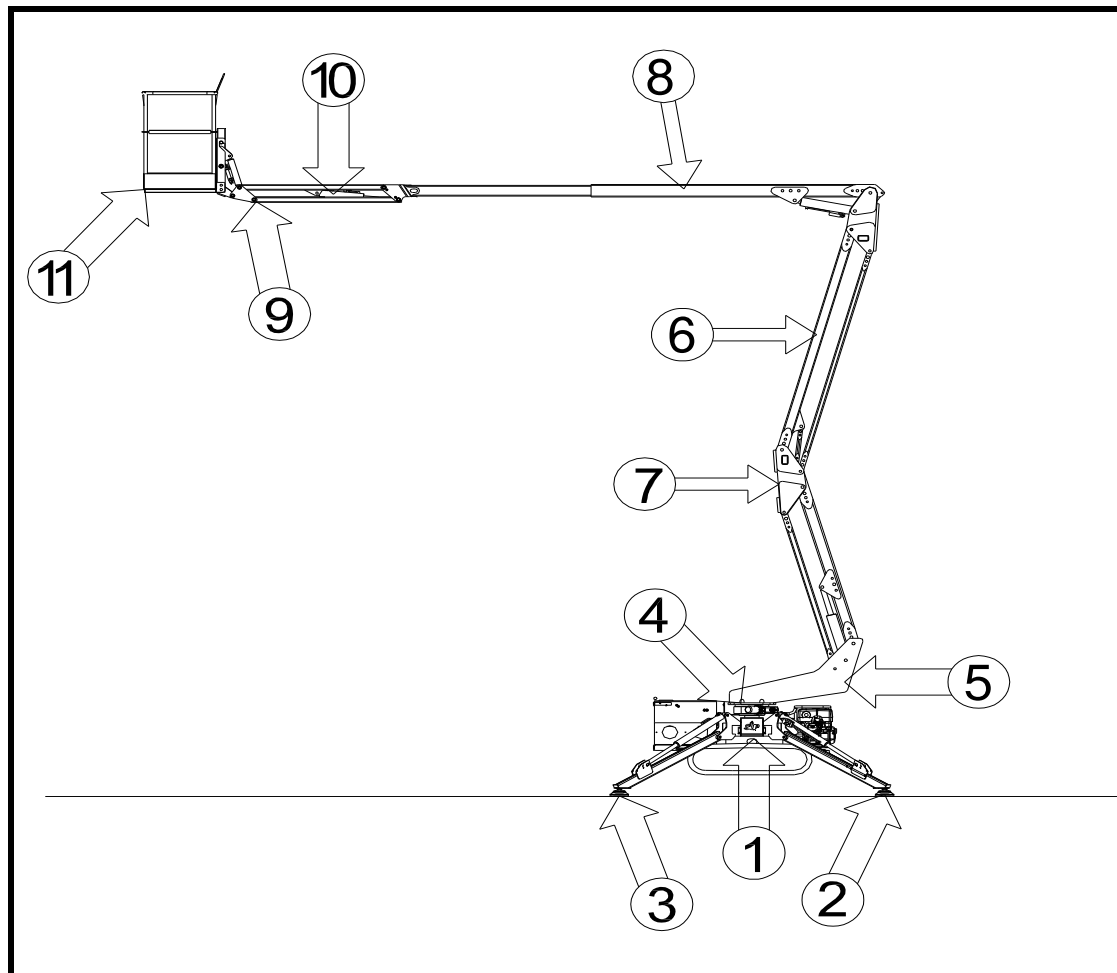

Picture 3: MEWP main components.



2.3.1 ▶ Frame

The frame **1** (Picture 3), in quality steel structure, equally divide the equipment's weight when the MEWP is in transport position. The frame has 4 oil-pressure jack booms for stabilization [2 front stabilizer cylinders **2** (Picture 3), 2 rear stabilizer cylinders **3** (Picture 3)]. The basis for the bearing is placed on the frame **4** (Picture 3), it enables the swinging of the equipment through the rotation group.

2.3.2 ▶ Turret

The turret **5** (Picture 3), in quality steel, is fixed on the bearing. It is started by a hydraulic engine (whose brake is normally closed), placed inside the turret. It enables the rotation of the superstructure.

2.3.3 ▶ Pantograph

The pantograph **6** (Picture 3) is composed by two couples of parallel booms and by the pantograph connecting rod **7** (Picture 3). The booms (tubular with rectangular section, press-formed and electro welded) and the connecting rod are in quality steel sheets. The movement of the pantograph (pantograph lifting and descent) is realized by the pantograph lifting oil-pressure cylinder. This cylinder is hinged to the turret (rod side) and to the pantograph upper crank (stem side) and it has a double effect balancing valve This cylinder is hinged to the turret.

2.3.4 ▶ Telescopic boom

The telescopic boom **8** (Picture 3) is hinged to the turret. The telescopic boom is composed by two elements: 1 fixed boom, hinged to the pantograph connecting rod, and 1 sliding boom.

The sliding or re-entry movement of the telescopic boom is activated by operating the "telescopic boom sliding cylinder device".

The lifting or descent movement of the telescopic boom is activated by operating the "telescopic boom lifting cylinder device".

2.3.5 ▶ Jib

At the end of the telescopic boom is hinged an boom named Jib **9** (Picture 3). The lifting or descent of the jib is done by operating the "Jib lifting cylinder" **10** (Picture 3).

2.3.6 ▶ Basket

In aluminium tubular, the basket **11** (Picture 3) has a lateral opening to allow the entrance of the operators. The lateral opening is an auto-shutter and built to avoid accidental openings. The basket has strong points for safety belts, a guard-rail 1,1 m high from the basket floor, an intermediate guard-rail and a foot protecting band along all sides of the platform. The floor is in antiskid and auto-draining aluminium. The basket is removable: it is connected to a support through which it is possible to couple it with the jib.

3 ▶▶ Control positions ◀◀

3.1 ▶ Machine switching on/off station ◀

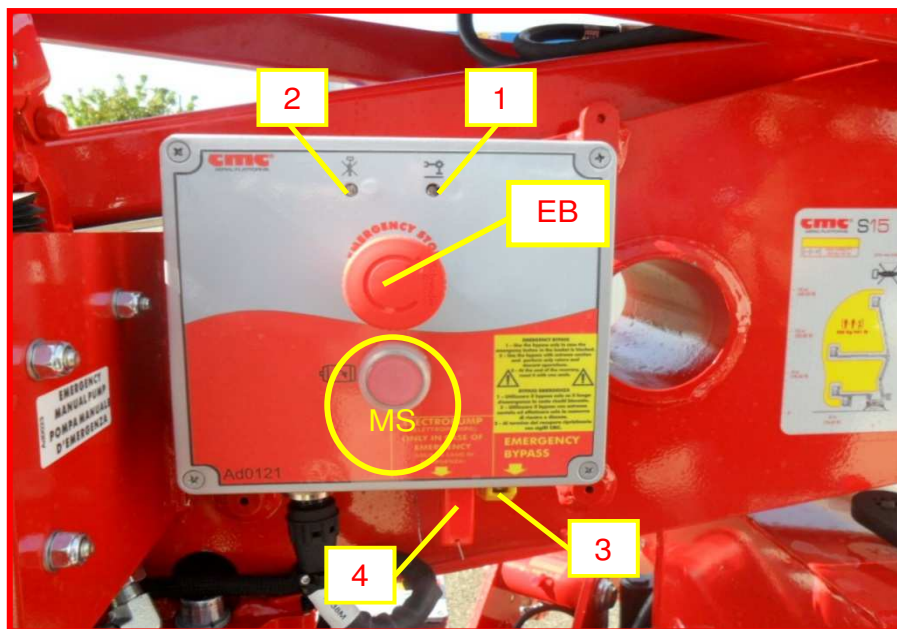

Picture 4: control station for engine switching on/off.

In the switching on/off station, allocated on the left side of the chassis, it is possible to push the button **MS** (Picture 4) to start the auxiliary electric engine (*optional).

In this station, there are also:

- **EB emergency button** (Picture 4): red and mushroom-shaped, it blocks the machine by removing the power supply to the control circuits. This switch has priority over any other command: it makes possible only the manual emergency lowering of the machine on the ground.

- **led 1 for stabilization consent** (Picture 4): if lighted on, it allows the movement of the outriggers only when the boom and pantograph are resting on their supports.
- **led 2 for platform use consent** (Picture 4): if lighted on, it allows the maneuvers of the aerial part only when stabilization is correctly performed.
- **emergency bypass 3** (Picture 4): it disables the safety function of emergency button (par. 4.6.2)
- **electropump activation lever 4** (Picture 4): it is an alternative energy source for the electric engine power (par. 4.6.6).

3.1.1 ▶ Other power supplies *optional

The machine can be supplied on customer request:

- with diesel engine, instead of standard petrol engine, and with auxiliary electric engine;
- in a completely electric version 48 V powered by 160 Ah lithium batteries.



It is not possible to use the endothermic engine and the electric one (*optional) at the same time.





It is not possible to have the 48 V electric engine and the 110/120/230 V engine fitted on the machine at the same time.

The electric engine, if present, can be activated also by turning to the left the selector **7** in the basket control station (Pictures 9a-9b).

To recharge the batteries (no engine activated):

1. couple the 110/120/230 V socket (power line) to the plug on the machine and lift the button provided on the machine's thermal magnetic panel;
2. the batteries will be charging and, if the electric system is ON, the progress of the charging process will be shown on both the control station display and the appropriate leds of the box in the basket.

 When the state of batteries charge, during the use, reaches the lowest level (under 10%), all work maneuvers will be interrupted, and it will only be possible to close the machine again.

 It is absolutely forbidden to direct high-pressure jets of water onto the support containing the battery pack. High water pressure could generate serious and irreversible problems in the operation of the machine.

3.2 ▶ Platform control stations ◀

The command stations of the platform are:

- the travel control station (Picture 5);
- the outriggers controls (Picture 8);
- the operating control station, placed on the basket, for the use of the aerial part (Picture 9),
- the emergency one, placed on the turret, for the recovery of the aerial part from the ground (Picture 11).

 It is not possible to use two different command stations at the same time.

3.2.1 ▶ Travel control station

 Check that there is nobody in the travel area and that the machine is in transport configuration (jib closed, pantograph and boom on support, centered turret, stabilizers raised).

The travel of the machine can be performed by using the wired remote control, usable on the ground (the activation of this directly excludes the use of the basket control station), which has:

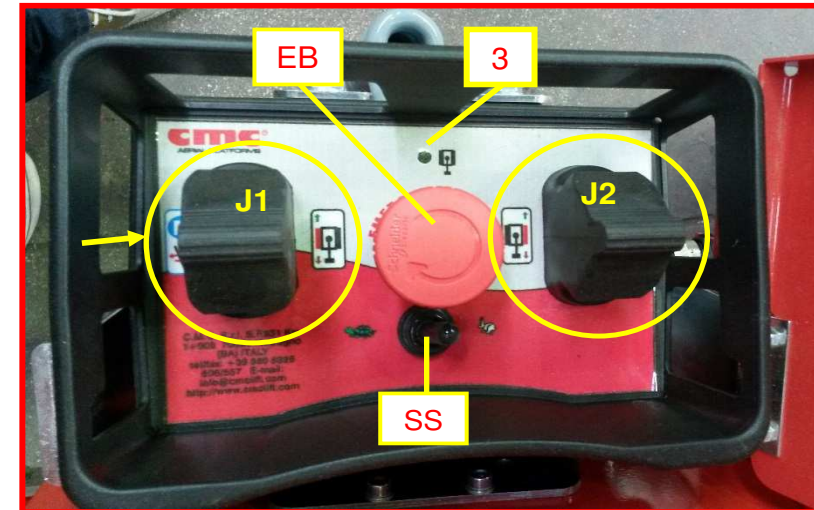

Picture 5: wired remote control for MEWP travel.

- **left track joystick J1** (Picture 5):
 - pushing the joystick forward, the travel of the left track forward is obtained;
 - pushing the joystick backwards, the travel of the left track backward is performed.
- **right track joystick J2** (Picture 5):
 - pushing the joystick forward, travel of the right track forward is obtained;
 - pushing the joystick backwards, the travel of the right track backward is performed.
- **EB emergency button** (Picture 5): red and mushroom-shaped, it blocks the machine by removing the power supply to the control circuits. This switch has priority over any other command: it makes possible only the manual emergency lowering of the machine on the ground.

 The emergency button has an auto-detent mechanical locking system; therefore, it is necessary to unlock the button turning it clockwise to reset its operability.



- **SS travel speed selector** (Picture 5): moving the selector to the left, it selects the travel speed in “turtle” mode, while to the right the higher one in “hare” mode.



On the frame of the MEWP, there are stickers with coloured arrows that indicate the directions of travel set on wired remote control.



If the triple speed is present as an optional, to activate it, push the joysticks J1 and J2 to the maximum in concordance (both upwards or both downwards).

- **travel consent light 3** (Picture 5): orange light, which, if it is ON, indicates the consent to travel operations.

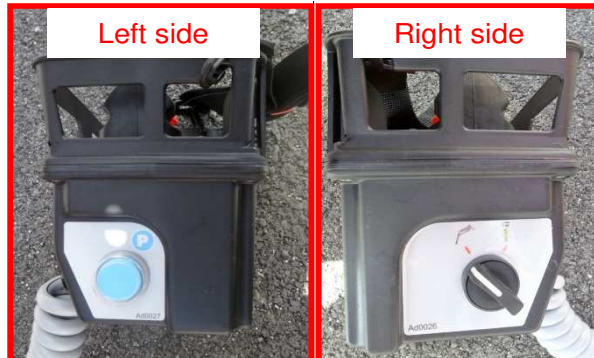

Picture 6: left and right side of wired remote control.

On the left side of the wired remote control, there is:

- **P parking button** (Picture 6): located on the left side of the wired remote control, if kept pressed, it allows the vertical movement of the tracks with the machine stabilized, in case of their replacement.

On the right side of it, there is:

- **selector for parking operations or travel operations** (Picture 6).

The remote control is placed in the special aluminium case showed in Picture 7. To work, it must be correctly connected to its connector.



Picture 7: location for remote wired control.

3.2.2 ▶ Outriggers control station

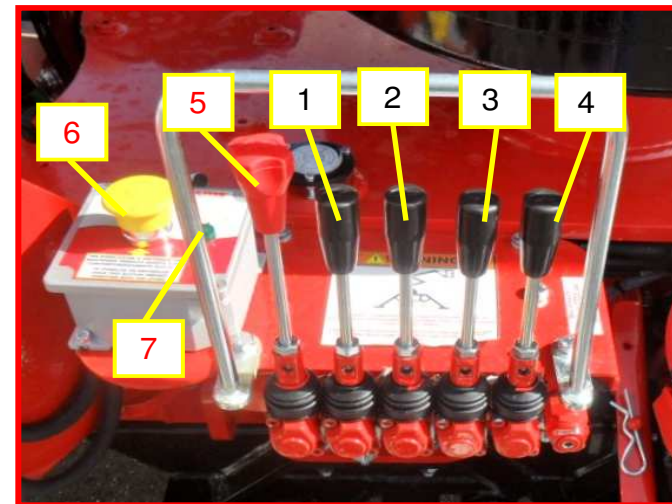

Picture 8: outriggers control station.

The outriggers control station (Picture 8) is positioned on the left side of the frame and, through it, it is possible to perform manual stabilization / destabilization of the MEWP. It consists of:



- **front left outrigger lever 1** (Picture 8);
- **front right outrigger lever 2** (Picture 8);
- **rear right outrigger lever 3** (Picture 8);
- **rear left outrigger lever 4** (Picture 8);
- **tracks extraction/retraction (*optional) red lever 5** (Picture 8);
- **“dead man” stabilizers button 6** (Picture 8): it must be held pressed together with other levers to stabilize or destabilize.
- **electrical power supply warning light 7** (Picture 8): green light, which, if it is ON, indicates that the MEWP is correctly and electrically powered.

For each lever, pushing it down, the lowering of the outriggers is produced; pushing it upwards, execute the re-entry of the same.

3.2.3 ▶ Platform operating control station

The platform (operating) control station is positioned inside the basket. If the machine is equipped with petrol/diesel engine or in hybrid version, it consists of (Picture 9a):

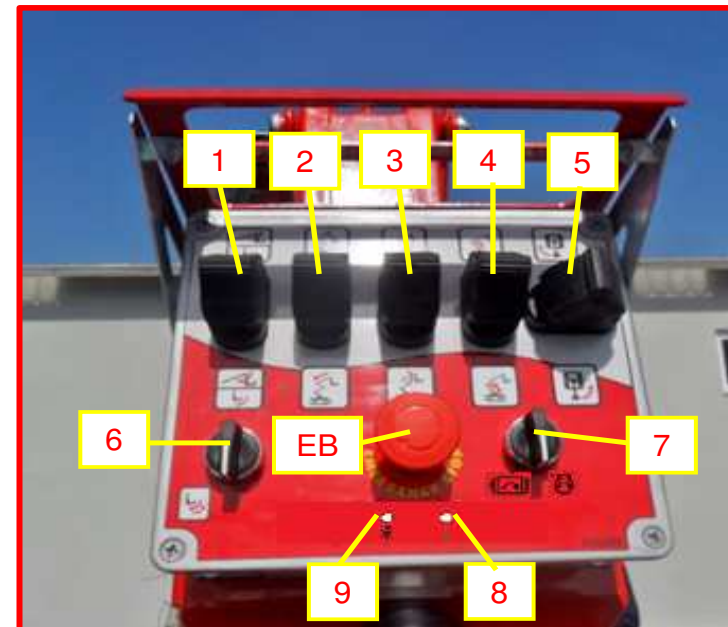

Picture 9a: platform (operating) control station for endothermic equipment.

- movement lever group (listed from left to right):
 - **joystick 1 for jib extension/retraction / basket levelling** (Picture 9a): downwards it makes the jib retraction or the internal levelling; upwards the jib extension or the external levelling.
 - **joystick 2 for extension/retraction of boom** (Picture 9a): downwards it produces the boom return, upwards the extension.



- **joystick 3 for boom lifting/lowering** (Picture 9a): downwards it raises the boom descent; upwards the boom lifting.
 - **joystick 4 for lifting/lowering of the pantograph** (Picture 9a): downwards it causes the descent of the pantograph; upwards the lifting.
 - **joystick 5 for turret rotation** (Picture 9a): downwards it causes the counterclockwise rotation, upwards the clockwise rotation.
 - buttons/selectors group:
 - **EB emergency button** (Picture 9a): red and mushroom-shaped, it blocks the machine by removing the power supply to the control circuits. This switch has priority over any other command: it makes possible only the manual emergency lowering of the machine on the ground.
-  **The emergency button has an auto-detent mechanical locking system; therefore, it is necessary to unlock the button turning it clockwise to reset its operability.**
- **“dead man” switch for levelling operation 6** (Picture 9a): for the levelling operation, it is necessary to keep pushing this switch to the left together with the **joystick 1**.
 - **engine start selector 7** (Picture 9a): turning this switch to the left, the electric engine starts, turning it to the right the endothermic one.
 - **electrical power supply warning light 8** (Picture 9a): green light, which is ON when it indicates that the MEWP is correctly and electrically powered;
 - **platform use consent light 9** (Picture 9a): green light, which is ON when it allows the use of MEWP aerial part.
 - **12 V socket** (Picture 9a): on the right side of the box.

If the machine is in full lithium version (*optional), the platform (operating) control station consists of (Picture 9b):

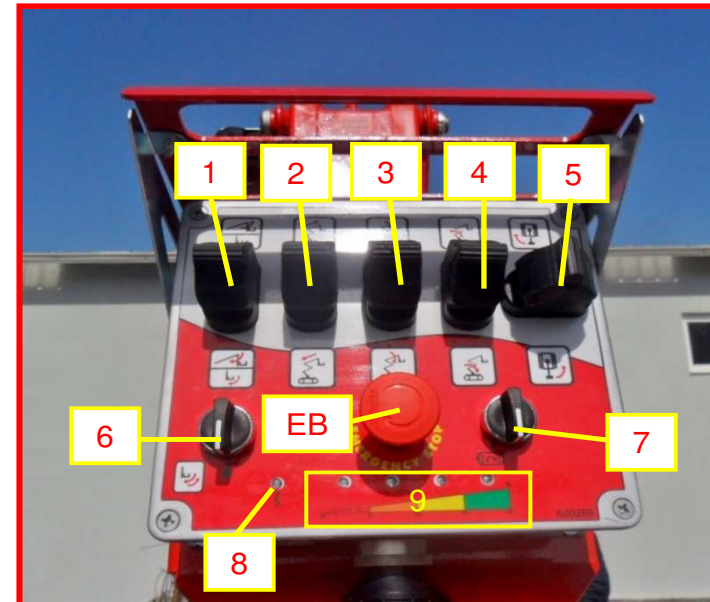

Picture 9b: platform (operating) control station for full lithium version (*optional).

- movement lever group (listed from left to right):
 - **joystick 1 for jib extension/retraction / basket levelling** (Picture 9b): downwards it makes the jib retraction or the internal levelling; upwards the jib extension or the external levelling.
 - **joystick 2 for extension/retraction of arm** (Picture 9b): downwards it produces the arm return, upwards the extension.
 - **joystick 3 for lifting/lowering of arm** (Picture 9b): downwards it raises the arm descent; upwards the arm lifting.



- **joystick 4 for lifting/lowering of the pantograph** (Picture 9b): backwards it causes the descent of the pantograph; upwards the lifting.
- **joystick 5 for turret rotation** (Picture 9b): downwards it causes the counterclockwise rotation, upwards the clockwise rotation.
- **EB emergency button** (Picture 9b): red and mushroom-shaped, it blocks the machine by removing the power supply to the control circuits. This switch has priority over any other command: it makes possible only the manual emergency lowering of the machine on the ground.



The emergency button has an auto-detent mechanical locking system; therefore, it is necessary to unlock the button turning it clockwise to reset its operability.

- **“dead man” switch for levelling operation 6** (Picture 9b): for the levelling operation, it is necessary to keep pushing this switch to the left together with the **joystick 1**.
- **electric engine start switch 7** (Picture 9b): pushing this switch to the left, the 48 V electric engine starts.
- **electrical power supply warning light 8** (Picture 9b): green light, which is ON when it indicates that the MEWP is correctly and electrically powered;
- **battery charge level indicator 9** (Picture 9b): it has four leds in different warning colors; each led indicates a state of batteries charge equal to 25%.



Every time the charge state of the batteries reaches 10%, all work operations are blocked.

- **12 V socket** (Picture 9b): on the right side of the box.

Finally, if the MEWP has the basket rotation as *ptional, the platform (operating) control station includes:

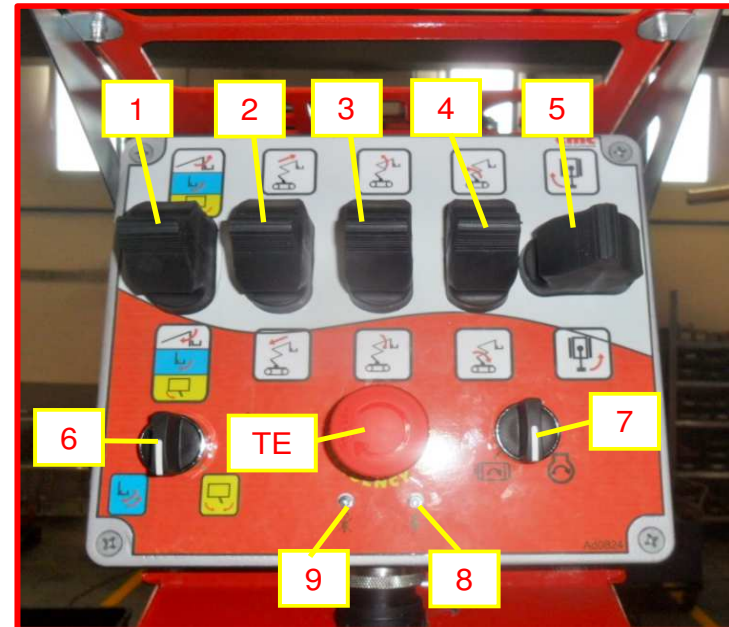

Picture 9c: platform (operating) control station for version with basket rotation (*optional).

- movement lever group (listed from left to right):
 - **joystick 1 for jib extension/retraction / basket levelling / basket rotation** (Picture 9c): downwards, it makes the jib retraction, the internal levelling or the counterclockwise rotation of the basket; upwards the jib extension, the external levelling or the clockwise rotation of the basket.
 - **joystick 2 for extension/retraction of boom** (Picture 9c): downwards it produces the boom return, upwards the extension.
 - **joystick 3 for boom lifting/lowering** (Picture 9c): downwards it raises the boom descent; upwards the boom lifting.



- **joystick 4 for lifting/lowering of the pantograph** (Picture 9c): downwards it causes the descent of the pantograph; upwards the lifting.
 - **joystick 5 for turret rotation** (Picture 9c): downwards it causes the counterclockwise rotation, upwards the clockwise rotation.
 - buttons/selectors group:
 - **EB emergency button** (Picture 9c): red and mushroom-shaped, it blocks the machine by removing the power supply to the control circuits. This switch has priority over any other command: it makes possible only the manual emergency lowering of the machine on the ground.
-  **The emergency button has an auto-detent mechanical locking system; therefore, it is necessary to unlock the button turning it clockwise to reset its operability.**
- **“dead man” switch for basket levelling/rotation operations 6** (Picture 9c): for the levelling operation, it is necessary to keep pushing this switch to the left together with the **joystick 1**; for the basket rotation, it is necessary to keep pushing this switch to the right together with the **joystick 1**.
 - **engine start selector 7** (Picture 9c): turning this switch to the left, the electric engine starts, turning it to the right the endothermic one.
 - **electrical power supply warning light 8** (Picture 9c): green light, which is ON when it indicates that the MEWP is correctly and electrically powered;
 - **platform use consent light 9** (Picture 9c): green light, which is ON when it allows the use of MEWP aerial part.
 - **12 V socket** (Picture 9c): on the right side of the box



Picture 10: “dead man” pedal (*optional) and left side of basket control station.

There may be also the following *optional devices in basket:

- **joystick for basket rotation** (*optional): this additional knob, on the basket control station, allows you to rotate the basket to the left or right.
- **“dead man” pedal** (Picture 10): this pedal (*optional) must be pressed simultaneously with joysticks for all manoeuvres.
- **electropump** (*optional) **activation button** (Picture 10).

3.2.4 ▶ Platform emergency control station

The emergency control station is positioned under the turret and is useful in emergency situations and in case of machine block for the recovery of the MEWP aerial part.

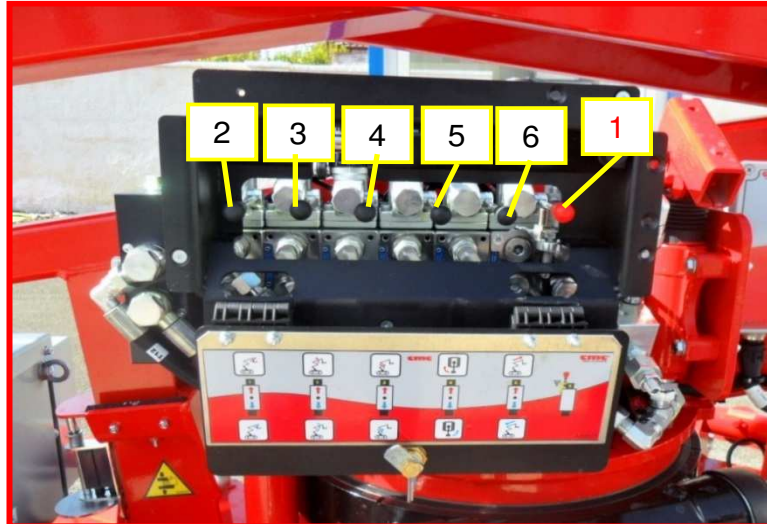

Picture 11: emergency control station.

It is formed by:

- **proportional lever 1** (Picture 11): it is activated simultaneously with the other manoeuvres;
- **lever 2 for lifting/lowering of the jib** (Picture 11): it produces the lifting (lever at the top) and the descent (lever at the bottom) of the jib;
- **lever 3 for lifting/lowering of the boom** (Picture 11): it carries out the lifting (lever at the top) and the descent (lever at the bottom) of the boom;
- **lever 4 for lifting/lowering of the pantograph** (Picture 11): it produces the lifting (lever at the top) and the descent (lever at the bottom) of the pantograph;
- **lever 5 for turret rotation** (Picture 11): it activates the clockwise rotation (lever at the top) and the counterclockwise rotation (lever at the bottom) of the turret.
- **lever 6 for extension/retraction of the boom** (Picture 11): it activates the extension (lever at the top) and the retraction (lever at the bottom) of the boom.



4 Use procedures

4.1 Environmental exercise conditions

The equipment can work normally in the following environmental conditions (for uses in different conditions, a special equipment is required):

- **temperature from -20°C (-4°F) to +55°C (131°F)** (even +70°C (158 °F) for short periods which do not exceed 24 h);
- humidity from 30% to 90% (at 20°C);
- **max wind speed 12,5 m/s** (45 Km/h - 27,96 mph).

Do not cover the equipment with cloths in order to avoid condensation inside the electrical boards.
After storage in closed and very wet places for a long period, the machine could have some problems due to condensation in the electrical boards: in this case, should this occur, please contact the C.M.C. Service before use.



Do not work in areas with dangerous environmental conditions: poor visibility, storms, lightning risk, etc.



Do not work inside refrigerating rooms.



Do not operate when the wind speed exceeds a 12,5 m/s (45 Km/h). We hereby enclose the Beaufort wind scale (Table 1):

Wind power		Wind speed		Land conditions
Beaufort number	description	m/s	Km/h	
0	Calm	0-0,2	1	Calm. Smoke rises vertically
1	Light air	0,3-1,5	1-5	Wind motion visible in smoke.
2	Light breeze	1,6-3,3	6-11	Wind felt on exposed skin. Leaves rustle
3	Gentle breeze	3,4-5,4	12-19	Leaves and smaller twigs in constant motion.
4	Moderate breeze	5,5-7,9	10-28	Dust and loose paper raised. Small branches begin to move. Dust and loose paper raised. Small branches begin to move.
5	Fresh breeze	8-10,7	29-38	Branches of a moderate size move. Small trees begin to sway.
6	Strong breeze	10,8-13,8	39-49	Large branches in motion. Umbrella use becomes difficult.
7	Near gale	13,9-17,1	50-61	Whole trees in motion. Effort needed to walk against the wind
8	Gale	17,2-20,2	62-74	Twigs broken from trees. It is difficult to move
9	Severe gale	20,3-24,4	75-88	Light damages to buildings, tiles removed
10	Storm	24,5-28,4	>89	Trees are broken off or uprooted, heavy damages to buildings

Table 1: Beaufort wind scale.



We recommend the use of an anemometer, to determine direction and speed of wind.



4.2 ▶ Safety distances ◀

Below there are the safety distances to be kept by qualified staff (alternating current):

Voltage field of electric line	Minimum safety distance
Up to 300 V	Avoid contact
300 V < x > 750 V	1 ft. 0 in. (30,5 cm)
750 V < x > 2 kV	1 ft. 6 in. (46 cm)
2 kV, < x > 15 kV	2 ft. 0 in. (61 cm)
15 kV < x > 37 kV	3 ft. 0 in. (91 cm)
37 kV < x > 87.5 kV	3 ft. 6 in. (107 cm)
87.5 kV < x > 121 kV	4 ft. 0 in. (122 cm)
121 kV < x > 140 kV	4 ft. 6 in. (137 cm)

4.3 ▶ Transport, storage and package ◀

To load/unload the platform, it is possible to use a travelling crane of adequate capacity. For this operation, sling the MEWP as in Picture 12 by the coupling at the feet of the outriggers and on the chassis.

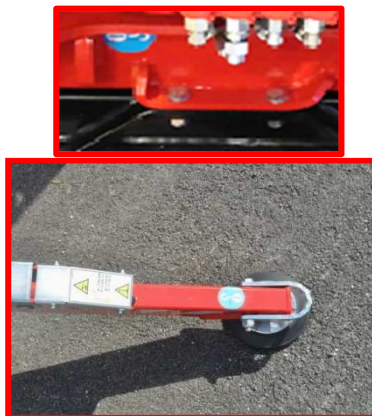

Picture 12: couplings for machine sling.

- ☞ Lifting operations must be carried out when the machine is closed.
- ☞ Be careful not to damage machine.
- ☞ Always use the personal protection equipment; do not handle ropes or chains without gloves.
- ☞ The presence of people in proximity of MEWP during the operations is forbidden.

Alternatively, the loading/unloading can be done through ramp, exploiting the motricity of the machine as well as its ability to overcome **slopes not >14° (25%)**. If you choose this option, please proceed with the following procedure, and carefully reading the danger notes suggested.

- ☞ Comply with the rules in force about width, height, weight and transport speed allowed. Check that the limit gauge is compatible with the features of the route to be made (i.e. galleries, bridges, electrical and phone lines, etc.).



WARNING! In both cases, it is advisable to remove the basket to reduce encumbrances and favor the operations.



For loading/unloading operations by ramps, use the wired remote control from the ground.

4.3.1 ▶ Loading/uploading through ramp



Picture 13: loading/uploading through ramp by wired remote control.

Check that no one is in proximity and that the MEWP is in transport configuration.

To ensure a better stability during loading/uploading operations, it is possible to disassembly the basket and to extract the tracks (*optional), widening the ground encumbrance.

0. Unhook the basket by removing the pin and pulling it upwards, decoupling it from the support mounted on the jib. Reposition the pin in the bush and reinsert the cotter pin.
1. Connect the travel control station (Picture 5).
2. Place a couple of ramps and bring them in correspondence of the machine tracks.

In case of climb on a truck, use loading ramps of adequate size and strength.

Check that the ramps slope (attack) does not exceed 16° (29%) with jib closed and 30° (58%) with jib lifted and on engine side. Verify that ramps are perfectly clean from grease, mud, snow or ice.

3. Start the petrol/diesel or electric engine.
4. Control the travel operations slowly and only in the direction indicated in the following figure: the basket, if not disassembled, shall always be placed at the rear of the machine.

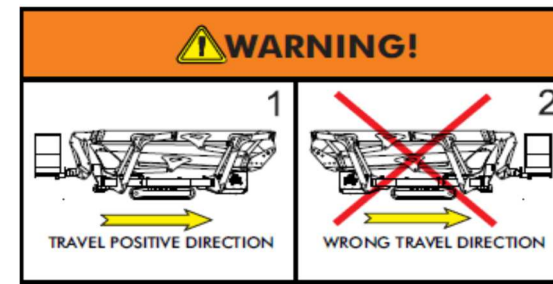

Picture 14: right travel direction.

5. Turn off the machine engine.
6. Ensure the MEWP to the truck plane.

WARNING! If you get the machine on a truck, secure the machine to the truck plane by couplings on the chassis and on the outriggers. Keep the machine switched off during the transport.

4.4 ▶ MEWP use procedures ◀

The following procedures shall be carefully carried out in the correct chronologic order.



If full lithium version, before any work start, check the battery charge level. It is necessary to have at least 75% of battery charge, otherwise it is advisable to charge them before working.

4.4.1 ► Placement in the working area

1. Turn on the engine (Picture 4).
2. With machine ready to travel or to be stabilized, identify the working area which is nearest to the place to reach, and reach it by the travel joysticks **J1** and **J2** (Picture 5).



C.M.C. obligates to use the wired remote controls, in order to perform the travel operations in complete safety.

3. Make sure the soil bears the load of the outriggers and check that there are no manholes, floors or other soft structures in the contact point of every outriggers plate with the ground.



If these conditions are not met, it is strictly forbidden to use the MEWP.

4. Be careful not to exceed the maximum slope limits that can be faced by the machine: 14° (25%) longitudinally e 10° (18%) transversally.

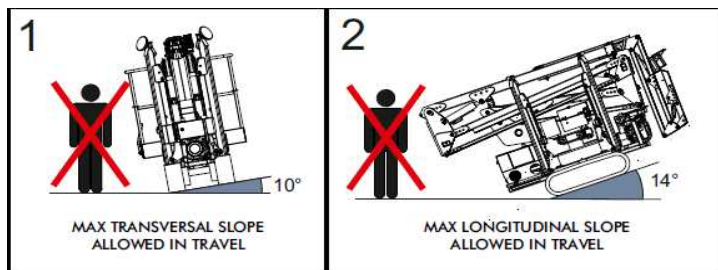

Picture 15: maximum slopes allowed in travel.

5. Place the MEWP on the chosen area.
6. Mark the working area with proper signs (white-red tape, white-red chains, pins, etc.).



When traveling, respect a distance of at least 4 meters and make sure that no one stays within a radius of at least 5 meters.

4.4.2 ► MEWP stabilization

The MEWP has only one stabilization area, given by the openings of the front and rear outriggers. An electronic locking system uniquely ensures the working area.

The movement of the outriggers must be possible only when the boom and the pantograph are resting on their supports. This is signalled by the lighting up of led 1 on the machine switching on/off box (Picture 4).

7. Reach the outriggers control station (Picture 8);
8. Using the “Outriggers control station”, lower the front and rear outriggers with the levers **1**, **2**, **3**, **4** (Picture 8). The release of the outriggers leads first to the contact of the four outriggers plates with the ground and then to the lifting of the frame. Proceed with the complete stabilization of the machine.



STABILIZE ONLY WITH CLOSED TRACKS!



It is essential to carry out stabilization by operating all four levers simultaneously. Once the plates have touched the ground, it will be possible to continue to perform alternate cycles first on the two front stabilizers and then on the two rear stabilizers.



Check that maximum slope to stabilize not exceed 8° (14%).

9. Check the machine levelling, by watching the air bubble level on the counter frame: the maximum frame slope allowed is 1°.



10. Once stabilization is complete, led 2 (Picture 4) will light up to signal the stabilization completion and the consent to the maneuvers of the aerial part of the platform.

4.4.3 ▶ Basket assembly and access

11. To carry out the basket operations, it is necessary to go ahead with the basket assembly after having turned off the machine.



Picture 16: basket coupling.

12. Once the basket is coupled, insert the pin and the cotter pin highlighted in Picture 16.
13. The entrance into the basket occurs lifting the self-locking closing bar and using the underlying step; **ensure that the bar is back into the closing position; fasten the safety belts to the proper handholds in the basket.**

4.4.4 ▶ Basket levelling

14. After verifying that the led 2 (Picture 4) is on, using the platform control (operating) station, operate the basket levelling (par. 3.2.3).



The levelling maneuver is active only if the machine is stabilized.



It is strictly forbidden to carry out the levelling operation of the basket with the machine developed.



Perform the operation of levelling the basket only when the aerial part of the MEWP is in the transport configuration (telescopic boom retracted and completely lowered, pantograph lowered, turret centred).

4.4.5 ▶ Use of the aerial part

15. Using the platform control (operating) station, carry out the MEWP aerial part operations through the joystick controls described in the paragraph 3.2.3.



First lift the pantograph in order to rise it from the support.



It is strictly forbidden to rotate the turret as first movement since it could cause heavy damages to the carpentry.

4.4.6 ▶ Setting the MEWP in the transport position

16. To place the MEWP in the transport position, it is necessary to first return the aerial part and then destabilize the machine.
17. Operate the MEWP aerial part closing, lowering the pantograph on their support, centring the turret, returning the boom, by using the platform control (operating) station.

! WARNING! Center the turret before lowering the booms.

18. Unfasten safety belts, get off the basket using its underlying step.
19. Perform the withdrawal of the outriggers, running the appropriate levers **1**, **2**, **3**, **4** (Picture 8).

! During the destabilization, proceed by carrying out the operations in the following sequence:

- a. close the tracks;
- b. lift the stabilizers.

During these operations, keep away from the tracks and pay attention to the feet.

20. Finally, it is possible to restart the MEWP to bring it back to the parking position.

! If full lithium version, at the end of the work, always remember to charge batteries.

4.5 ▶ Battery pack recharge ◀

For full lithium version, in order to recharge the battery pack (Picture 17), it will be necessary to stall the machine.

Then operate according to the following procedure:

1. push the **MS** button (Picture 4) to switch off the machine;
2. couple the 110/120/230 V plug (power line) to the connector on the machine and press the appropriate button of the magnetothermic switch;
3. now the batteries will be in charge and the charge progress can be evaluated through the leds **9** on the basket control station (Picture 9b).



Picture 17: battery pack.

The charge times are:

BATTERY CHARGE	TIME
0% - 80%	4 h
80%-100%	2 h

With a full charge (100%), S15 Eco-Battery is able to perform at least 10 work cycles. A work cycle includes the following sequence of operations:

- 1) stabilization;
- 2) complete machine development;
- 3) complete machine return;
- 4) destabilization.

! AT THE END OF EACH WORKING SESSION AND HOWEVER AT LEAST EVERY 15 DAYS, IF THE MEWP IS NOT USED, ABSOLUTELY RECHARGE THE BATTERY PACK.



4.6 ▶ Emergency operations ◀



Before starting the emergency procedures, it could be useful to contact C.M.C. Service and communicate errors/problems.

4.6.1 ▶ Emergency button

In case of emergency, push the emergency buttons:

- on the centre of the control station in the basket (Picture 9);
- on the centre of the wired remote control (Picture 5);
- on the centre of the switching on/off box (Picture 4).

Pushing this button (with mechanical retention), the endothermic or electric* engine of the MEWP is turned off and all manoeuvres are disabled. To restore normal operating conditions, this button must be turned clockwise.

To secure the machine, perform the following procedures in the chronological order indicated:

1. recovery of the aerial part;
2. closing of the stabilizers;
3. travel of the tracks.

4.6.2 ▶ Emergency bypass

In case the operator in the basket has pushed the emergency button and is unable to reset it to its original position (due to fainting or other), it will be possible to disable that safety function through the yellow lever **3** "EMERGENCY BYPASS" below the machine switching on/off box (Picture 4).

The ground operator has to remove the lead safety seal and disable the emergency through an internal ON/OFF lever:



It will be care and responsibility of the operators, at the end of the operations, to reset the original conditions, including the resealing with seal compulsorily branded "C.M.C."

4.6.3 ▶ Failure of hydraulic system

In case of emergency (exhaustion of batteries charge, electric power failure, etc..), to obtain pressure inside the hydraulic circuit, necessary to the movement of the MEWP's components, you can use the electropump (*optional), if installed, activating it as described in paragraph 4.5.6.

Once the electropump has started, carry out the recovery operations of the aerial part through the emergency control station (Picture 11).

In case of absence of the electropump, the manual pump can be used for emergency recovery of the MEWP.

4.6.4 ▶ Failure of electric system

In case of electrical system failure, to obtain pressure inside the hydraulic circuit and to perform emergency recovery of the MEWP, it is necessary the presence of two operators and the use of manual pump.

4.6.5 ▶ MEWP recovery in case of simultaneous hydraulic and electric failure (use of manual pump)

In case of emergency (hydraulic system failure if not available electropump, or simultaneous failure of the hydraulic and electrical system), to obtain the pressure inside the hydraulic circuit, you can use the manual pump.

The manual pump lever must be inserted in the appropriate position shown in Picture 18, between the emergency control station and the machine switching on/off station.



Picture 18: insert for manual pump.

Aerial part recovery:

Since it is necessary to first recover the aerial part:

- unscrew the blue hydraulic tap knob **BV** (Picture 19), to enable the aerial part operations;

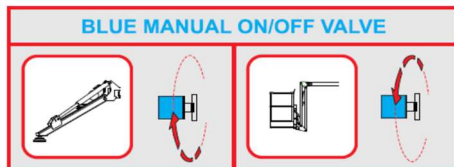

Picture 19: manual on/off valve for stabilizers/aerial part exchange feed.

- remove the seal from the golden lock ring, then the ring, so screw the cursor of the left exchange electrovalve **1L** (Picture 20);
- unscrew the tap knob on the exchange electrovalve **2L** (Picture 20);

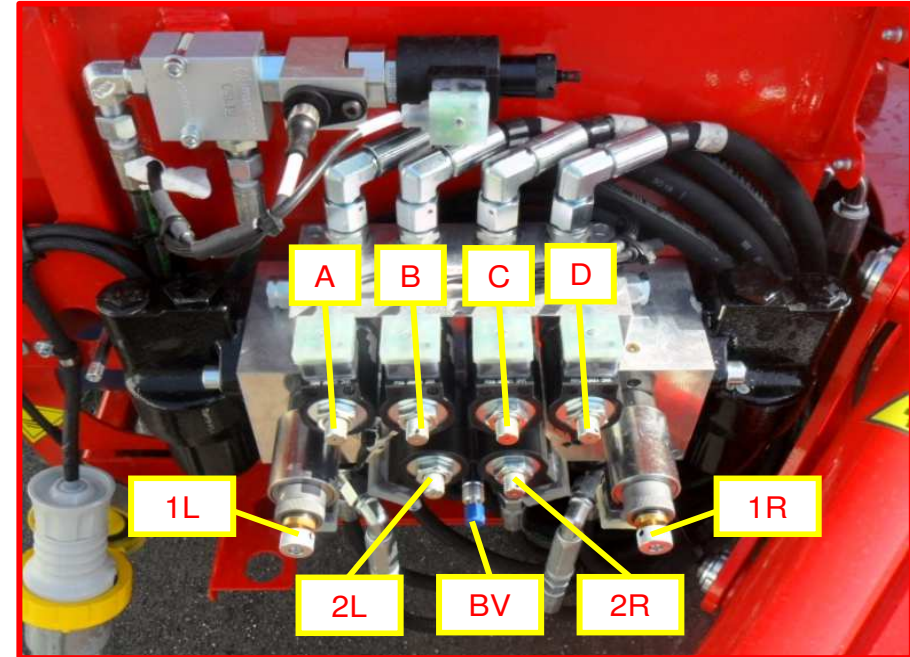

Picture 20: hydraulic distributor group.

- while the operator on the ground operates the pump (after inserting the supplied lever), the operator inside the basket can withdraw and lower the boom and then the pantograph, using the "platform operating control station" (Picture 9).
- after returning the platform to the rest position, the operator in the basket can carry out the operations of leveling and rotation, in order to safely exit the basket.
- at the end of this procedure, return the sliders and the valves to their original state.

Stabilizers recovery:

Subsequently, when the basket is empty, destabilize the MEWP:

- screw the tap knob **BV** (Picture 19), to enable the stabilizers operations;



- remove the seal from the golden lock ring, then the ring, so screw the cursor of the right exchange electro valve **1R** (Picture 20);
- unscrew the tap knob on the exchange electrovalve **2R** (Picture 20);
- while an operator moves the manual pump, the other one performs operations to return the stabilizers, moving the levers of the "outriggers control station" (Picture 8).



When returning the MEWP to the transport configuration, the deceleration ramps of the maneuvers will be inactive: therefore, pay particular attention to the operations wearing all the personal protection devices provided for by law.

Tracks recovery:

For the MEWP travel, move the tracks using the valves at the top in the hydraulic distributor shown in the Picture 20:

- with the left exchange electrovalve **1L** (Picture 20), the valves **A** (Picture 20) and **B** (Picture 20) all screwed up, press the cursor A to move forward the left track and the cursor B to move backward it;
- with the right exchange electrovalve **1R** (Picture 20), the valves **C** (Picture 20) and **D** (Picture 20) all screwed up, press the cursor C to move forward the right track and the cursor D to move backward it.

The electrovalves 1L and 1R are proportional, then you could set the travel speed by screwing them more or less.



After completely closing the MEWP, bring the electrovalves back to their original state and take the MEWP to the nearest Service Center authorized by C.M.C.

4.6.6 ▶ Electropump (*optional)

The emergency electropump (12 V), if requested, is an alternative energy source for the endothermic engine power (Picture 21).



It is to be used only in case of emergency. Every different use is not recommended because it can produce unexpected discharge of batteries, absorbing current directly from them.



Picture 21: emergency electropump (*optional).

If installed, the emergency electropump can be activated (powered) by pressing:

- the button on left side of basket control stations (Picture 10);
- the lever 4 (Picture 4) on switching on/off box.

4.7 ▶ Safety rules ◀



THE NON-COMPLIANCE WITH ANY OF THE FOLLOWING SAFETY RULES, MAY CAUSE SERIOUS DAMAGES TO PEOPLE, THINGS AND PARTS OF THE EQUIPMENT OR THE MACHINE.



4.7.1 ▶ Before and during the movements with MEWP in transport position

 It is forbidden to rent the MEWP without non-trained operators and staff.

→ The hirer is responsible for the training of his operators and of the staff renting the MEWP. C.M.C. s.r.l. declines any responsibility coming from damages to people and/or things due to the inexperience of these operators;

 Do not use the MEWP under drug or alcohol effect;

 Do not use the MEWP under stress conditions;

 Do not use the MEWP if you suffer from dizzy spells;

→ Before driving, check the tires wear state and the correct inflation pressure;

→ Drive with caution, respecting the highway code;

→ Take the MEWP height overall dimensions into consideration during circulation, in order to avoid clashing against bridges, galleries, underpasses and other obstacles;

 Do not use the MEWP to perform drawing or pushing operations;

 Do not use the MEWP as an off-road vehicle;

4.7.2 ▶ Before positioning the MEWP

→ Carefully and chronologically follow the instructions given in this manual;

 Use the MEWP only with the environmental operating conditions indicated in paragraph 4.1;

→ Check that the staff allowed to use the MEWP is skilled and trained, and that they know the MEWP use and maintenance rules;

→ Check that the safety devices are working and efficient; some components (outriggers integrated groups, max pressure valve on the turret), important for the MEWP safety, are calibrated in C.M.C. plants and the containers are sealed before delivering of the MEWP to the customer.

 It is strictly forbidden to tamper with such components. The absence of the sealing within the machine warranty terms causes the immediate retraction of the warranty as well as the accountability – by the user – of the liabilities coming from an incorrect functioning of the safety devices.

 Do not remove or modify safety devices;

 It is forbidden to modify, remove or replace any MEWP component (ballasts, tires, batteries, spare tire etc.): this operation could reduce the machine weight thus impairing its stability;

→ Wear all the protective cloths and the personal safety devices: helmets, safety shoes and - according to the type of work - gloves, hearing protections, respirators, etc.;

 Do not use clothes with hanging flaps, scarves, ties or any other accessory which could be dragged into the moving parts; inform about the closest fire-extinguishers and first-aid kit.

4.7.3 ▶ During the positioning of the MEWP

 It is forbidden to operate in situations which are dangerous for the safety of people;

 Do not operate in explosion hazard areas;

→ Check that the working area is suitable to the MEWP performances and operations, and that it is enough lit;



- Check that the operational stands and the working area are enough lit and well visible;
- If operating in closed or little aired environment, ensure, before starting the machine engine, that his has appropriate ventilation or convey exhaust gases outside:



Exhaust emissions produced by the MEWP engine are toxic;

- Appropriately define the working area through suitable signs; observe the laws in force about the traffic, in case you use the MEWP where road circulation is allowed;
- Check that nobody is within the MEWP action range.
- Stabilize the truck through the outriggers.



Pay the utmost attention during stabilization: check that no one is inside the stabilization area.

- Check that the outriggers rest on a non-soft, solid ground that bears the load indicated on each stabilizer.
- In case of soft ground, use supporting plates.



It is forbidden to place the outriggers on ground roughness: they could be damaged.

- Level the machine in order to let the MEWP operate on a horizontal plane: max frame slope 1° - max slope which can be assimilated by the ground 3°.

4.7.4 ▶ During the entrance in the basket



It is absolutely forbidden to use the equipment with loads different from those indicated on the diagram or for uses which are not allowed;



Do not overload the MEWP;

- **During the different working operations, the use of the safety belts is compulsory.** Do not fasten the safety belts to external structures but only to the supplied grips placed in the basket;
- Make sure that the bar lifted to enter the basket, has returned in its lock position.

4.7.5 ▶ During the use of the MEWP

- In any dangerous or irregular conditions, stop the machine by using the emergency button. Before restarting the machine, check that the dangerous conditions are over;



It is strictly forbidden to level the basket when the machine is in working position;



Do not operate when the MEWP is in failure;



It is forbidden to use the “platform control (emergency) position” when there are operators inside the basket, unless there is emergency or for testing operations before starting the work (which shall be carried out without anyone in the basket): from downstairs, it is difficult to estimate how far the basket and the MEWP structure components are from possible obstacles;

- Follow the MEWP working diagram.;



It is strictly forbidden to use the platform as a crane, to hang posters, banners, poles, etc. to the basket or to any other part of the MEWP.;



















Do not connect chain or ropes to the MEWP (since they could be trapped amongst the MEWP moving parts or they could hook fixed objects thus causing the machine overturn);



It is absolutely forbidden to lift or lower loads by using ropes and pulleys;



-  It is forbidden to lean out;
-  It is forbidden to use the MEWP for recreational purposes;
-  Do not perform the basket rotation operation together with other operations;
-  No material shall fall from above: fasten the working material properly;
-  Do not throw objects (tools) upside down or vice versa.
-  In case of works like pruning, plants maintenance, etc., it is forbidden to let trunks, pipes, poles etc. fall inside the basket or on the MEWP structure: they can severely impair the MEWP stability;
- ➔ During works like paintings, etc., protect yourselves and the machine;
-  It is strictly forbidden to put tools, body parts in the areas marked by the stickers indicating crushing, shearing hazard; keep hands away from any hole or slit;
-  It is forbidden to use tools not complying with the laws in force;
- ➔ When working at low temperatures, it is necessary to perform some in-vain operation so that the hydraulic circuit oil reaches the operating temperature;
-  It is forbidden to let people walk or stay within the MEWP working area;
-  It is forbidden to stay on the counter frame floor, during MEWP operations.
- ➔ Firmly cling to the work platform during lift and descent;

- ➔ Controls shall be started by slow and gradual movements:
-  Do not operate controls swiftly and suddenly
-  It is forbidden to make the platform swing;
- ➔ Check the MEWP stability during all the operations phases;
- ➔ Do not move the machine during working operations;
- ➔ Keep enough safety distance from the obstacles: avoid contacts with fixed (buildings, etc.) and moving (vehicles, cranes, etc.) objects, with the truck cabin, with the outriggers and with other structure parts;
-  It is forbidden to use ladders or tables on the basket in order to increase the MEWP outreach or working height;
- ➔ Be careful when working in close buildings: due to the “wind tunnel” effect, sudden blasts could cause swinging, thus impairing the machine stability;
-  It is forbidden to lift “full surface” panels (signs, advertising panels, boards, etc.): these could cause the “sail” effect;
-  It is forbidden to leave the MEWP unattended when it is in working position;
-  It is forbidden to exceed the max number of basket operators allowed;
-  During the normal use of the platform, it is absolutely forbidden to use electronic instruments which do not meet the requirements of the directive 72/245/CE and its following amendments: the additional electronic instruments could impair good functioning of the platform electronic components.



4.7.6 ▶ At the end of the works

- ➔ Before moving the machine, check that the MEWP aerial part is set in the transport position: check that the pantograph is on its own support, that the telescopic boom is withdrawn and rests on its own support;
- ➔ Before moving the machine, check that that all the outriggers are set in the transport position, with the plates completely lifted;

4.8 ▶ Safety devices ◀

A - Electrical devices

- Removable key for the MEWP start.
- Emergency self-blocking buttons placed in all control positions.
- Microswitch which stops the outriggers controls when the boom and the pantograph have been lifted and extended.
- Microswitch for the stabilizer end of stroke.
- Overloading protection fuses, both on power and control circuits.
- All the machine controls need the presence and action of the operator.
- Emergency bypass.
- Electropump*.

B - Hydraulic devices

- Maximum pressure valves.
- Block valve and parachute valve mounted on the lifting cylinders.
- Manual pump for the emergency operations.
- Oil flow adjuster for the control of the descent speed.

C - Mechanical devices

- Hydraulically controlled negative disc brakes.
- At least 1,10 m (3.61 ft) height of border guardrail on the basket.
- Basket access self-locking bar.
- Basket with safety belts eyelets.



All safety devices could wear out and lose their calibration, it is therefore necessary to control and keep them in perfect working order.

Do not rely totally on these devices to assess your working and safety conditions; in any case, the operator must have a proper and conscious use of the machine.

5 ▶▶ Markings ◀◀

On the machine there are the following marks.

- ➔ Before using the MEWP, it is compulsory to check the presence and the perfect readability of these marks. In case of absence or decay of the marks, contact the Service.

 C.M.C. s.r.l. Via Bitritto, 119 70124 BARI - ITALY Tel. 080 5326606/557 http://www.cmclift.com E-mail: info@cmclift.com			
TYPE	S15	MANUFACTURER	CMC
MODEL	S15	YEAR	
SERIAL NR.		TOT. WEIGHT	lbs
CAPACITY	508 lbs	INCLUDING	2 persons
MAX HYDRAULIC OPERATING PRESSURE	3336 PSI		
MAX MANUAL HORIZONTAL FORCE ALLOWED	90 lbs		
MAX WIND SPEED ALLOWED	28 mph		
MAX FRAME INCLINATION ALLOWED	1°		
EXTERNAL POWER SOURCE	120 V	60 Hz	

Picture 22: identification plate (fac-simile).

CMC S15

Picture 23: MEWP model mark.

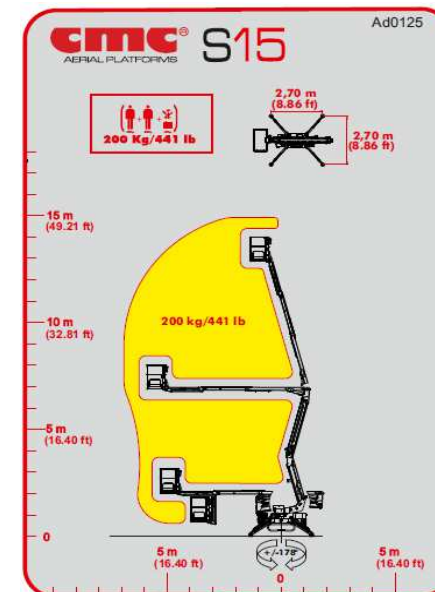

Picture 24: working diagram with maximum load 200 kg (441 lb).

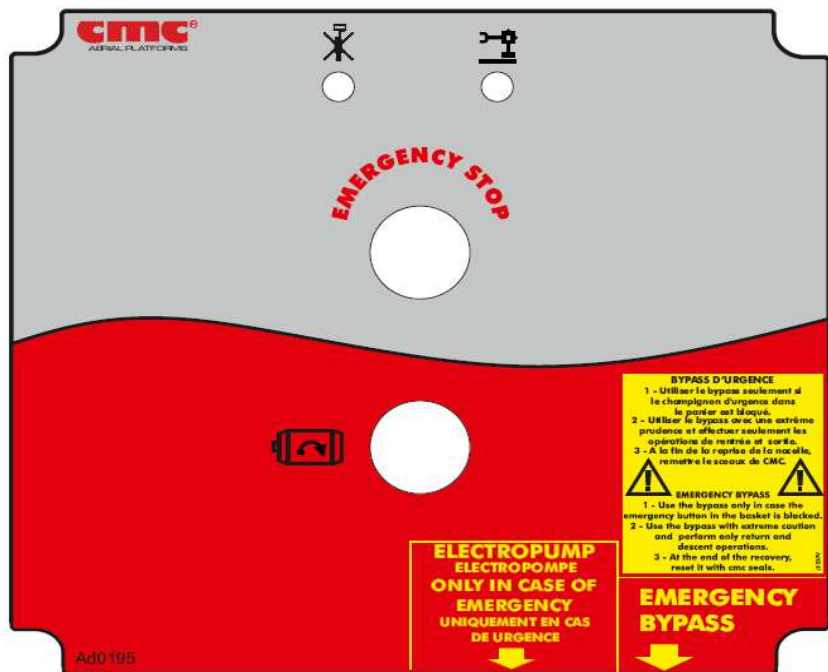

Picture 25: switching on/off box with Honda engine.



Picture 26: switching on/off box with Yanmar engine.

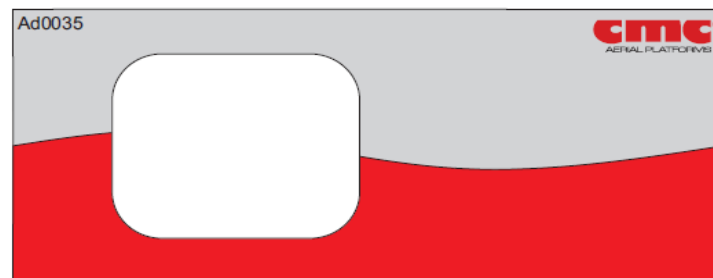

Picture 27: display.



DISPLAY CODE	DESCRIPTION	
95	Undefined machine status	Statut de la machine non défini
C0	Machine on tracks dlosed (travel)	Machine sur des pistes fermées (translation)
C2	Machine on tracks with at least one stabilizer on the ground	Machine sur les pistes avec au moins un stabilisateur au sol
C3	Machine on column stabilized and inclined	Machine sur la colonne incliné et stabilisé
P0	Machine on column stabilized	Machine sur la colonne stabilisé
P1	Machine developed and stabilized	Machine développée et stabilisée
P2	Machine developed with at least one stabilizer lifted	Machine développée avec au moins un stabilisateur soulevé

Picture 28: list of machine status.

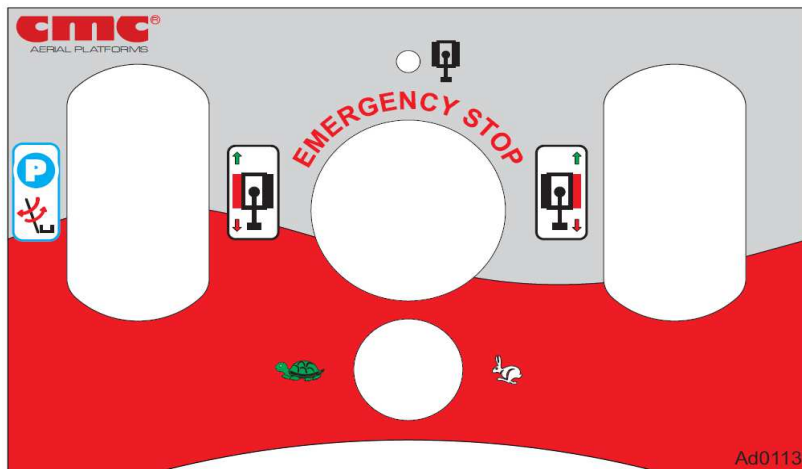

Picture 29: wired remote control.

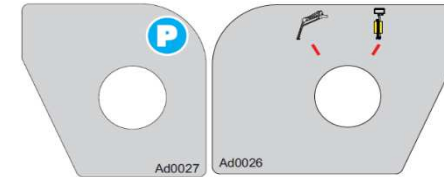

Picture 30: left and right side of wired remote control.

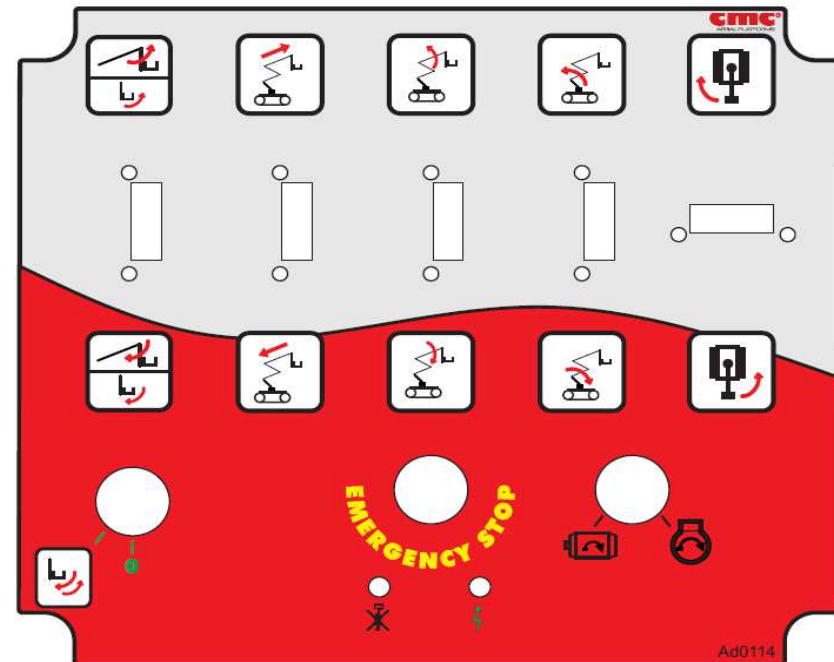

Picture 31a: basket control station with petrol/diesel engine or in hybrid version.



CAUTION/PRUDENCE

It is forbidden to load objects or persons during operations / C'est interdit de charger des objets ou des personnes pendant les opérations.

CAUTION/PRUDENCE

It is forbidden to stand within the working area of the platform during operations / Il est interdit de se tenir dans la zone de travail de la plate-forme pendant les opérations.

CAUTION/PRUDENCE

Use these controls only in case of emergency / Utilisez ces commandes uniquement en cas d'urgence.

WARNING/ATTENTION

Only trained staff shall operate the machine / Seul le personnel formé doit utiliser la machine.

WARNING/ATTENTION

It is forbidden to replace any component without CMC's authorization / Il est interdit de remplacer un composant sans l'autorisation de CMC.

DANGER!

High voltage! Haute tension!

The platform is not electrically insulated/ La plate-forme n'est pas électriquement isolée.

Keep the minimum distance from the power lines according to the table below / Respectez la distance minimale entre les lignes électriques selon le tableau ci-dessous.

Voltage/Tension	Distances	
	Feet	Meters/mètres
0 to 50 kV	15 ft	4.6 m
50 to 100 kV	15 ft	4.6 m
100 to 250 kV	20 ft	6.1 m
250 to 500 kV	25 ft	7.6 m
500 to 750 kV	35 ft	10.7 m
750 to 1000 kV	45 ft	13.7 m

Not applicable for every 100V class 0V

MOBILE ELEVATING WORK PLATFORM USE GUIDELINES
DIRECTIVES D'UTILISATION POUR UNE PLATE-FORME DE TRAVAIL

IT IS THE OPERATOR'S RESPONSIBILITY TO PERFORM A SITE INSPECTION PRIOR TO SETTING UP THE OUTRIGGERS. ONLY SETUP THE MEWP ON SAFE AND SOLID GROUND / C'EST LA RESPONSABILITE DE L'OPERATEUR D'EXECUTER UNE INSPECTION DE SITE AVANT DE METTRE EN PLACE LES OUTRIGGERS. INSTALLER UNIQUEMENT LA PLATE-FORME SUR UNE SURFACE SURE ET SOLIDE.

IT IS MANDATORY THE USE OF THE SAFETY-BELTS AND ALL APPROVED PERSONAL PROTECTION EQUIPMENT / L'UTILISATION DES CEINTURES DE SECURITE ET DE TOUT L'EQUIPEMENT DE PROTECTION INDIVIDUELLE EST OBLIGATOIRE.

DO NOT USE THE MEWP AS A CRANE TO LIFT LOADS / NE PAS UTILISER LA PLATE-FORME COMME UNE CRUE POUR LEVER LES CHARGES.

ALWAYS FOLLOW THE INSTRUCTIONS IN USE AND MAINTENANCE MANUAL / TOUJOURS SUIVEZ LES INSTRUCTIONS DU MANUEL D'UTILISATION ET DE MAINTENANCE.

Center the turret before lowering the pantograph and the booms / Centrez la tourelle avant d'abaisser le pantographe et les booms.

Picture 34: turret indications.

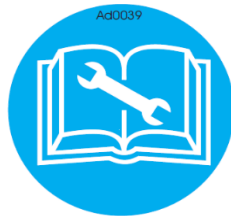

Picture 35: obligation to consult the manual.

Ad0660 **Safety fall arrest belt attachment point. Stop only 1 person**
Point d'attache de la ceinture de sécurité. Arrêt une seule personne
Picture 36: safety belt attachment points in basket.

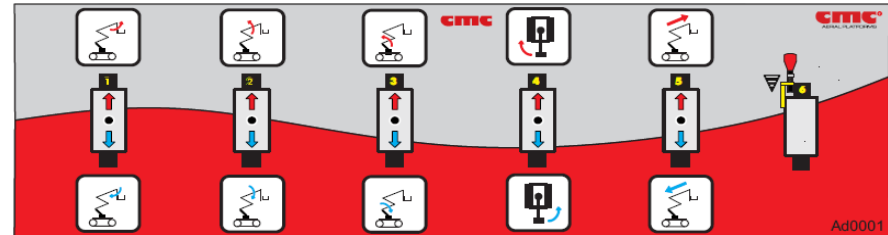

Picture 37: emergency control station.

WARNING! When you destabilize, carry out the operations in the following order:
1: Close the tracks;
2: Close the stabilizers.
During the operations, stand off the tracks and watch your feet.

ATTENTION! Quand tu déstabilises, effectuer les opérations dans l'ordre suivant:
1: Fermez les stabilisateurs;
2: Fermez les pistes.
Pendant les opérations, attention aux pieds et éloignez-les des pistes.

Picture 38: outriggers control station.



Picture 39: dead man box for stabilization/destabilization.

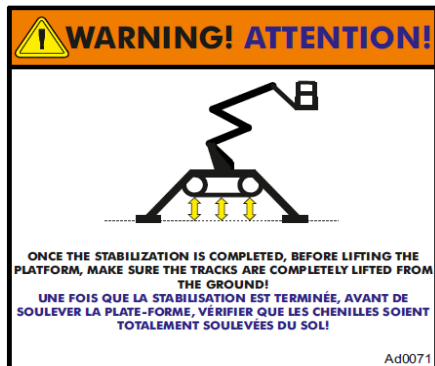

Picture 40: warning for stabilization.



Picture 41: general obligations and prohibitions.



Picture 42: indication of fuel (gasoline or diesel).



Picture 43: indication of air/water supplies.



Picture 44: indication for grease application.



Picture 45: indication for oil refill.



Picture 46: indication for engine oil checking.



Picture 47: indication for engine oil adding.



Picture 48: indication of minimum/maximum oil level.

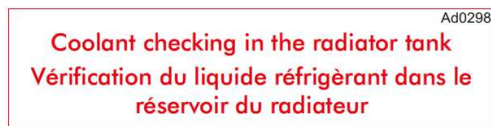

Picture 49: indication for coolant checking.



Picture 50: indication for coolant refill.



Picture 51: indication of basket levelling valves.



Picture 52: indication of insert for emergency manual pump lever.

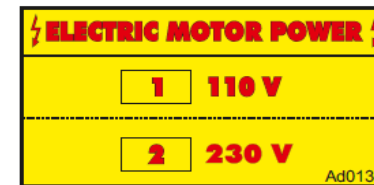

Picture 53: auxiliary electric motor power (*optional).



Picture 54: engine battery cut off switch.



Picture 55: battery pack (*optional).



Picture 56: battery pack charger (*optional).

<p>Max pressure <small>Ad0206</small> 230 bar/3336 psi FILTERS BENCH BANC DE FILTRES</p>
<p>Max pressure 220 bar/3191 psi TURRET BENCH BANC DE TOURELLE</p>
<p>Max pressure 190 bar/2755 psi TRAVEL BENCH BANC DE TRANSLATION</p>
<p>Max pressure 190 bar/2755 psi OUTRIGGERS BENCH BANC DES STABILISATEURS</p>
<p>Max pressure 120 bar/1740 psi LEVELING VALVE VANNE DE NIVELLEMENT</p>
<p>Max pressure 90 bar/1305 psi TURRET ROTATION ROTATION DE LA TOURELLE</p>

Picture 57: list of maximum pressures.



Picture 58: indication of frame coupling.

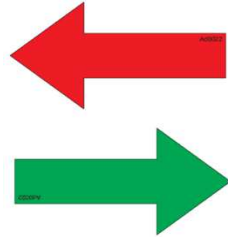

Picture 59: direction arrows on tracks for travel.

WARNING! ATTENTION! Ad0207 (R)

IF YOU DRIVE UPHILL, IT IS COMPULSORY TO KEEP THE MACHINE AS INDICATED IN THE FIGURE: BASKET AND JIB RAISED FORWARD.

SI TRASLATION VERS LE HAUT, IL EST OBLIGATOIRE DE GARDER LA MACHINE COME INDIQUÉ DANS LA FIGURE: PANIER ET JIB RELEVÉS À L'AVANT.

WARNING! ATTENTION! Ad0207 (L)

IF YOU DRIVE UPHILL, IT IS COMPULSORY TO KEEP THE MACHINE AS INDICATED IN THE FIGURE: BASKET AND JIB RAISED FORWARD.

SI TRASLATION VERS LE HAUT, IL EST OBLIGATOIRE DE GARDER LA MACHINE COME INDIQUÉ DANS LA FIGURE: PANIER ET JIB RELEVÉS À L'AVANT.

Picture 60: warning for travel in slope.

WARNING! ATTENTION! Ad0202 (L)

MAX. TRANSVERSAL TRAVEL SLOPE: 10°
PENTE MAXIMUM DE VOYAGE TRANSVERSAL

MAX. LONGITUDINAL TRAVEL SLOPE: 14°
PENTE MAXIMUM DE VOYAGE LONGITUDINAL

EXACT TRAVEL DIRECTION: DIRECTION DE VOYAGE EXACTE

WRONG TRAVEL DIRECTION: DIRECTION DE VOYAGE ERRONÉE

IT IS MANDATORY TO CLIMB/GO DOWN WITHIN MAXIMUM VALUES SET IN FIG.1 AND FIG.2. BEFORE TRAVELLING, MAKE SURE THE WAY IS CLEAR FROM GREASE, MUD, SNOW, OR ICE. DURING TRAVEL OPERATIONS, THE OPERATOR SHALL ALWAYS KEEP AT LEAST 1.5/1.2 M (4 ft) AWAY FROM THE MEWP.

IL EST OBLIGATOIRE DE MONTER / DE DESCENDRE DANS LES VALEURS MAXIMALES INDICUÉES À LA FIG.1 ET FIG.2. AVANT DE VOYAGER, ASSUREZ-VOUS QUE LA VOIE EST LIBRE DE LA GRAISSE, DE LA BOUE, DE LA NEIGE OU DE LA GLACE. PENDANT LES OPÉRATIONS DE VOYAGE, L'OPÉRATEUR DOIT TOUJOURS SE TROUVER AU MOINS 1.5 (1.2 M) DE LA PENTE.

TRAVEL AND CLIMB WITH THE MEWP SET AS SHOWN IN FIG.1.
SE DÉPLACER ET GRIMPER AVEC LA PENTE RÉGLÉE COMME INDIQUÉ À LA FIG.1.

THE BASKET SHALL ALWAYS BE PLACED AT THE REAR (FIG.1).
LE PANIER DOIT TOUJOURS ÊTRE PLACÉ À L'ARRIÈRE (FIG.1).

WARNING! ATTENTION! Ad0202 (R)

MAX. TRANSVERSAL TRAVEL SLOPE: 10°
PENTE MAXIMUM DE VOYAGE TRANSVERSAL

MAX. LONGITUDINAL TRAVEL SLOPE: 14°
PENTE MAXIMUM DE VOYAGE LONGITUDINAL

EXACT TRAVEL DIRECTION: DIRECTION DE VOYAGE EXACTE

WRONG TRAVEL DIRECTION: DIRECTION DE VOYAGE ERRONÉE

IT IS MANDATORY TO CLIMB/GO DOWN WITHIN MAXIMUM VALUES SET IN FIG.1 AND FIG.2. BEFORE TRAVELLING, MAKE SURE THE WAY IS CLEAR FROM GREASE, MUD, SNOW, OR ICE. DURING TRAVEL OPERATIONS, THE OPERATOR SHALL ALWAYS KEEP AT LEAST 1.5/1.2 M (4 ft) AWAY FROM THE MEWP.

IL EST OBLIGATOIRE DE MONTER / DE DESCENDRE DANS LES VALEURS MAXIMALES INDICUÉES À LA FIG.1 ET FIG.2. AVANT DE VOYAGER, ASSUREZ-VOUS QUE LA VOIE EST LIBRE DE LA GRAISSE, DE LA BOUE, DE LA NEIGE OU DE LA GLACE. PENDANT LES OPÉRATIONS DE VOYAGE, L'OPÉRATEUR DOIT TOUJOURS SE TROUVER AU MOINS 1.5 (1.2 M) DE LA PENTE.

TRAVEL AND CLIMB WITH THE MEWP SET AS SHOWN IN FIG.1.
SE DÉPLACER ET GRIMPER AVEC LA PENTE RÉGLÉE COMME INDIQUÉ À LA FIG.1.

THE BASKET SHALL ALWAYS BE PLACED AT THE REAR (FIG.1).
LE PANIER DOIT TOUJOURS ÊTRE PLACÉ À L'ARRIÈRE (FIG.1).

Picture 61: maximum slopes and exact directions for travel.

BYPASS D'URGENCE

- 1 - Utiliser le bypass seulement si le champignon d'urgence dans le panier est bloqué.
- 2 - Utiliser le bypass avec une extrême prudence et effectuer seulement les opérations de rentrée et sortie.
- 3 - A la fin de la reprise de la nacelle, remettre le sceaux de CMC.

EMERGENCY BYPASS

- 1 - Use the bypass only in case the emergency button in the basket is blocked.
- 2 - Use the bypass with extreme caution and perform only return and descent operations.
- 3 - At the end of the recovery, reset it with cmc seals.

Ad0317

Picture 62: rules for emergency bypass use.



Picture 63: exchange electrovalve.

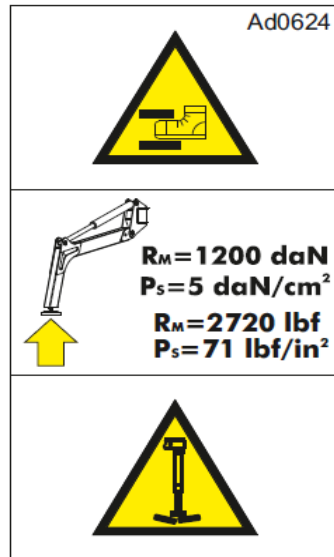

Picture 64: maximum load on stabilizers.



Picture 65: indication of platform fuse.

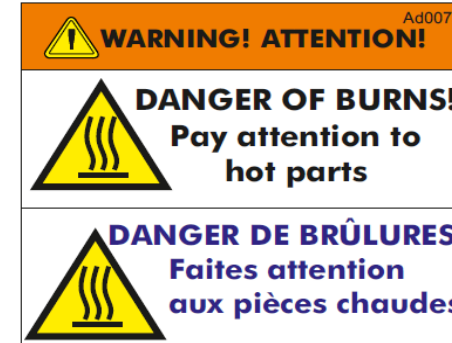

Picture 66: warning of burn risk.



Picture 67: generic advices on the frame.



Picture 68: electric earthing.



Picture 69: electric danger.



Picture 70: crushing and cutting hazard.



Picture 71: prohibition to wet the item.

MEWP USE GUIDELINES
DIRECTIVES D'UTILISATION DE LA PTE

CMC
AVANT PLACEMENT

- A daily check inspection of MEWP must be performed before its use. / Une inspection quotidienne de la PTE doit être effectuée avant son utilisation.
- The use of MEWP is allowed only to professional staff, properly trained and specialized. / L'utilisation de la PTE n'est autorisée que pour le personnel professionnel dûment formé et spécialisé.
- The operators have to check the working area before setting up the MEWP, to stabilize it on solid and safe ground surface. / Les opérateurs doivent vérifier la zone de travail avant de configurer la PTE, afin de la stabiliser sur une surface au sol solide et sûre.
- All the operators must wear the personal protection equipment. / Tous les opérateurs doivent porter l'équipement de protection individuelle.
- Do not use the MEWP as a crane to lift loads. / Ne pas utiliser la PTE comme grue pour lever des charges.
- Follow procedures described in «Use and maintenance manual». / Suivre les procédures décrites dans «Manuel d'utilisation et d'entretien».
- Travel the MEWP only when it is in transport position. / Conduisez la PTE uniquement lorsqu'elle est en position de transport.

Ad0208

Picture 72: MEWP use guidelines.



Ad0020
NOTICE/AVIS
<p>THIS AERIAL WORK PLATFORM IS BUILT ACCORDING TO US, ANSI 92.6 SECTION 4 and CAN/CSA B354.4-02 (R2013) about «Self-propelled boom-supported aerial elevating work platforms».</p> <p>LA PLATE-FORME DE TRAVAIL AÉRIENNE EST FAITE SELON LES NORMES US ANSI 92.6 SECTION 4 ET CAN/CSA B354.4-02 (R2013) «Plate-forme de travail aérienne avec élévation supportée par la flèche auto-propulsée».</p>

Picture 73: US and CAN standards respected.

Ad0031	NEXT INSPECTION DUE ON:	DATE:
	cmc AERIAL PLATFORMS	or WORKING HOURS

Picture 74: inspection registration.



6 ▶▶ Electrical system ◀◀

The electrical system is attached at this manual.

Periodically check the efficiency of the electric plant: batteries, alternator, charge regulator.



Any operation requiring interventions on the components of the machine, shall carried out by authorized and trained staff.



It is forbidden to replace the components for non-authorized staff. **Many components of the MEWP have been calibrated: a correct calibration of these parts (which is possible only in C.M.C. or in authorized Services) is important to assure the safety of the machine.**



7 ▶▶ Hydraulic system ◀◀

The MEWP hydraulic system is attached to the manual.

The pressure setting of the maximum valves must correspond to the following values:

Data	Value	Unit of measure
Turret workbench	220 (3191)	bar (psi)
Filters workbench	230 (3336)	bar (psi)
Outriggers workbench	190 (2755)	bar (psi)
Travel workbench	190 (2755)	bar (psi)
Levelling valve	120 (1740)	bar (psi)
Turret rotation	90 (1305)	bar (psi)



All the operations requiring the intervention on the components of the machine, shall be carried out by authorized and trained technical staff.



Non-authorized staff shall not replace any of the components. Many components have been calibrated: a correct calibration of these parts (possible only in C.M.C. or in authorized Services) is necessary to ensure the safety of the machine.



8 Maintenance

Working in safety also means working with equipment in accordance with law standards and under constant control.

Then, the employer must:

- select proper equipment, adapted to the environment and working conditions and to the characteristics of the worker who implements it;
- supervise that it is used appropriately, and that specific training is provided to workers;
- ensure that the work equipment is:
 - installed and used in accordance with the use instructions;
 - subject to proper maintenance in order to guarantee the permanence of the safety requirements
 - subject to the update of the minimum safety requirements set up with international specific regulations.

A correct use of the platform and a regular maintenance are crucial to keep it always in the best working, efficiency and safety conditions. The frequent washing of the equipment by high-pressure water jet machines is crucial to get rid of the harmful remains coming from the works performed and from atmospheric agents. Before washing, set the MEWP in driving position, stall the engine and take off the batteries.

To document what has been done, the employer therefore must draw up and update the proper control register.



Carefully read and scrupulously follow the maintenance instructions and safety laws during the maintenance.

The operations indicated with **USER** are to be performed by the user. The operations indicated with **C.M.C.** shall be performed only by C.M.C. srl or in authorized repair shops. Use only C.M.C. original spare parts (even if on the market there are equivalent or similar parts).

The frequency of the maintenances is indicated in every table. It is implied a normal use of the equipment; while, for particularly rough uses or in

harmful environments (presence of dust, sand, etc.), an optimal maintenance frequency is left to the good sense of the user.



If an intervention that is different from the following ones is necessary, ask the Technical Assistance Service for authorization and instructions.

8.1 Daily maintenance

Every day, before starting the MEWP, perform what follows:





All the following checks are to be performed operating the MEWP from the emergency position and without anyone inside the basket.





Operations by USER	In case of negative result of the checks:	Intervention by
Check the level of the hydraulic oil in the tank.	Top up	USER
Check the level of the fuel in the tank.	Top up	USER
Check the level of the refrigerating liquid.	Top up	USER
Check the batteries charge condition.	Charge or replace	USER
Check the cleanliness of the floor: oily or greasy residues could cause slipping.	Clean	USER
Check the wholeness of the instruction and warning labels.	Replace and/or integrate	USER



Operations by USER	In case of negative result of the checks:	Intervention by
<p>Perform the following testing operations by using the (emergency) controls placed on the turret when no one is aboard:</p> <ul style="list-style-type: none"> o lifting and lowering of the telescopic boom; o lifting and lowering of the jib; o clockwise and anticlockwise rotation of the turret; o extension and withdrawal of the telescopic boom. <p>During the test operations, check that the basket floors keeps a horizontal position.</p> <p>Check the functioning of the outriggers block valves, keeping the boom lifted:</p> <ul style="list-style-type: none"> o extend the outriggers and level the MEWP; o push the “EMERGENCY” button to turn off the engine; o operate the lever for the lifting and lowering of the outriggers. <p>OUTRIGGERS SHALL NOT MOVE.</p>	<p>If the problem can be solved following the instructions given in the paragraph “Trouble shooting”, perform the operations indicated in the said paragraph.</p>	USER
	<p> If the problem is not solvable following the instructions indicated in the paragraph “Troubleshooting”, it is strictly forbidden to use the MEWP. Contact the Servicing.</p>	C.M.C.

Operations by USER	In case of negative result of the checks:	Intervention by
<p>Check the functioning of the block valve of the boom extension cylinder:</p> <ul style="list-style-type: none"> o extend the boom and set it vertically; o push the “EMERGENCY” button to turn off the engine; o operate the lever for the telescopic boom extension and withdrawal; <p>THE BOOM SHALL NOT WITHDRAW.</p> <p>Check the functioning of the block valve of the boom lifting cylinder:</p> <ul style="list-style-type: none"> o load the basket with 200 kg (only weights); <p> During check, it is strictly forbidden to load the MEWP placing people in the basket.</p> <ul style="list-style-type: none"> o extend the telescopic boom; o push the “EMERGENCY” button to turn off the engine; o operate the levers for the lifting and lowering of the telescopic boom; <p>TELESCOPIC BOOM SHALL NOT MOVE.</p>	<p>If the problem can be solved following the instructions given in the paragraph “Trouble shooting”, perform the operations indicated in the said paragraph.</p>	USER
	<p> If the problem is not solvable following the instructions indicated in the paragraph “Troubleshooting”, it is strictly forbidden to use the MEWP. Contact the Servicing.</p>	C.M.C.



Operations by USER	In case of negative result of the checks	Intervention by
Check the absence of splits, cracks, rust on the structure of the MEWP	 It is strictly forbidden to use the MEWP. Contact the Servicing	C.M.C.
Check that the safety devices (emergency buttons, inter-block system for outriggers-boom) work perfectly	 It is strictly forbidden to use the MEWP. Contact the Servicing	C.M.C.
Check that the controls, the pilot lights, the emergency buttons work perfectly	 It is strictly forbidden to use the MEWP. Contact the Servicing	C.M.C.
Check the wholeness of the cable chains	 It is strictly forbidden to use the MEWP. Contact the Servicing	C.M.C.
Check that the blocking systems (pins, locknut, etc.) are in perfect condition and efficient	 It is strictly forbidden to use the MEWP. Contact the Servicing	C.M.C.

Operations by USER	In case of negative result of the checks:	Intervention by
Check the wholeness of the flexible pipes, of the pipe fitting and the components of the hydraulic circuit: check that there is no oil leakage in hydraulic circuit	Replacement	USER/ C.M.C.
Check that the electrical contacts are not slacken	Reset connections.	USER/ C.M.C.
Check that there is no trace of clashes on the equipment	 It is strictly forbidden to use the MEWP. Contact the Servicing.	C.M.C.

8.2 ▶ Weekly maintenance (or every 40 hours) ◀

Operations	by
Check the absence of splits, cracks, rust on the MEWP counter frame (use torches or lamps to inspect the internal part under the floor).	USER / C.M.C.
Check the cleanliness of the chassis engine and auxiliary motor air filter.	USER / C.M.C.
Check the cleanliness of the hydraulic filters.	USER / C.M.C.

8.3 ▶ Monthly maintenance (or every 120 hours) ◀

Operations	by
Greasing of pins and movable parts.	USER / C.M.C.
Washing of the equipment.	USER / C.M.C.
Check the tightening of the bolts of the bearing, the geared motor and the frame.	USER / C.M.C.



8.4 ▶ Quarterly maintenance (or every 300 hours) ◀

Operations	by
Check the tightening of the bolts of the bearing, the geared motor and the frame.	USER / C.M.C.

8.5 ▶ Maintenance after the first 400 hours ◀

Operations	by
Replacement of the hydraulic filters.	USER / C.M.C.
Registration of the movement of the booms.	C.M.C.

8.6 ▶ Six-monthly maintenance (or every 750 hours) ◀

Operations	by
Replacement of the hydraulic filters (25 micron).	USER / C.M.C.
Complete check of the whole machine and note the results in the appropriate manual section.	USER / C.M.C.

8.7 ▶ Annual maintenance (or every 1500 hours) ◀

Operations	by
Replacement of the hydraulic oil.	C.M.C.

For the replacement of the hydraulic oil, follow these instructions:

1. Place the machine in transport position with the oil at working temperature; to do that operate some manoeuvre before going on with the above-described operations.
2. Suck in the oil from the tank;
3. Dismantle the hydraulic filter;
4. Replace the filter;

5. Fill the tank letting the oil pass through a filter with 25 micron filtration.

N.B.: The dipstick is placed inside the oil tank cap. The tank is placed on the back of the turret base. The hydraulic filters are placed on the sides of the outriggers control station.

8.8 ▶ Biennial maintenance ◀

Operations	by
Complete check of the whole machine and note the results in the appropriate manual section.	C.M.C.

8.9 ▶ Five-yearly maintenance ◀

Operations	by
Complete check of the whole machine and note the results in the appropriate manual section.	C.M.C.



8.10 ▶ Safety rules during maintenance ◀



THE NON-OBSERVANCE OF ONE OF THE FOLLOWING SAFETY RULES CAN SERIOUSLY HARM PEOPLE OR CAUSE SEVERE DAMAGES TO THINGS OR PARTS OF THE EQUIPMENT OR OF THE MACHINE.

➔ To ensure the safety of the machine **the use of original spare parts installed by C.M.C. or by authorized repair shops is compulsory:** in fact, some components can be calibrated only c/or C.M.C. or in authorized workshops.



It is forbidden to perform maintenance operations when the MEWP moves: make sure that the parts to maintain are motionless and do these operations with the motor of the chassis stalled, taking the keys away from the panel;

➔ Perform the maintenance operations in a sufficiently large space and suited to the sizes of the truck: mark the area assigned for the maintenance operations by suited enclosure or by a red/white band ribbon and do not allow entrance to unauthorized staff.

➔ Do not modify or remove safety devices.

➔ Do not modify calibrated pieces.

➔ During the washing operation, do not lead the water jet directly on the electrical panels of the MEWP and do not use cleansing, aggressive chemicals dangerous for the components of the MEWP (rubber parts, painted parts, etc.).



It is forbidden to perform any intervention on parts of the MEWP, such as welding, piercing, and so on, without prior written authorization by C.M.C.

➔ Wear appropriate protective clothes (gloves, goggles, etc.).

➔ During maintenance operations, be careful not to damage the hydraulic circuit and avoid impurities in the circuit.

➔ Before any maintenance operation that involves the disassembly of hydraulic circuit parts, make sure that the system is not under pressure. In order to avoid violent emissions of oil, move all the levers of the control distributors, with the truck motor stalled and no component in movement.

8.11 ▶ Maintenance of endothermic engine ◀

The standard supplied petrol engine has the following technical characteristics:

- HONDA GX390 petrol engine, single cylinder OHV with horizontal shaft, 4 strokes, cylinder inclined at 25 °, forced air cooling, cast iron cylinders.

Data	Value	Unit of measure
Cylinder capacity	389	cm ³
Net power at 3600 rpm	8.7 (11.7)	kW (HP)
Maximum torque at 2500 rpm	26.5	N/m
Dry weight	69.89	lbs.
Dimensions (L x W x H)	1332 x 1509 x 1470	ft
Fuel consumption at 3600 rpm	3.5	l/h
Fuel tank capacity	6.1	l

Other supplied motor as optional* has the following technical characteristics:

- HONDA iGX390 petrol engine, single cylinder OHV with horizontal shaft, 4 strokes, cylinder inclined at 25 °, forced air cooling, cast iron cylinders.

Data	Value	Unit of measure
Bore x Stroke	Ø 88 x 64	mm



Cylinder capacity	389	cm ³
Net power at 3600 rpm	8.7 (11.7)	kW (HP)
Maximum torque at 2500 rpm	26,5	N/m
Dry weight	37,0	kg
Dimensions (L x W x H)	409 x 484 x 448	mm
Fuel consumption at 3600 rpm	3,5	l/h
Fuel tank capacity	6,1	l

- YANMAR L100, air-cooled diesel engine, vertical cylinder, 4 strokes.

Data	Value	Unit of measure
Bore x Stroke	Ø 86 x 75	mm
Displacement	0.435	liter
Continuous Rated Output (3000 - 3600 rpm)	5.7 - 6.2	kW
Maximum Rated Output (3000 - 3600 rpm)	6.3 - 6.8	kW
Engine weight (dry)	53.5	kg
Dimensions (L x W x H)	412 x 472 x 494	mm
Fuel tank capacity	5.4	liter

8.12 ► Maintenance of 48 V electric engine (*optional) ◀

The 48 V electric engine with battery pack, provided as optional* in full lithium version, has the following technical characteristics:

Battery specifics		
Battery Composition	LiFePo4	
Typical Capacity	160	[Ah]
Cells Configuration	15S1P	
Rated Voltage	48	[V]
Maximum Voltage Fully Charge	54.8	[V]
Minimum Operative Voltage	42	[V]

Rated Discharge Current	30	[A]
Maximum Discharge Current	100 (electronically limited)	[A]
Rated Charge Current	30 A (0.3 C)	
DoD	80	[%]
Cycle Battery Life	>2000 Ccle@80%DoD or >3000 Cycle@70%DoD	
Operative Temperature (during charge)	-20/+60*	[°C]
Operative temperature (during discharge)	-20/+60	[°C]
Battery Weight	70 approximately	[kg]
Maximum Output Power	4.8	[kW]
Rated Energy	4.32	[kWh]

*When charge is operated at less than 0°C the charge current is electronically limited at 10 A.

Battery charger specifics		
Voltage Input	100 - 240	Vac
Frequency Input	50 - 60	Hz
Maximum Output Voltage	>=60	V
Maximum Current	22	A
PWM Frequency	1	kHz
International Protection	IP20	
Weight	2,2	Kg
Dimension (L*W*H)	180x310x100	mm

8.13 ► Consumables ◀

Hydraulic oil:



Gazpromneft Hydraulic	HDZ ISO	32	46
Density, 15 °C, kg/l	ASTM D1298	0,867	0,872
Kinematic Viscosity, 40 °C, mm ² /s	ASTM D445	32	46
Kinematic Viscosity, 100 °C, mm ² /s	ASTM D445	6,32	8,03
Viscosity Index	ASTM D2270	151	154
Pour Point, °C	ASTM D97	-42	-42
Flash Point COC, °C	ASTM D92	204	216
Air release, 50 °C, min	ISO DIS 9120	5	6
Copper corrosion, 3 hrs, 100°C	ASTM D130	1a	1a
FZG, Damaged Load, A/8,3/90	DIN 51354	12	12

(hydraulic tank capacity: 40 lt)

Grease:

- for boom extension and outriggers:
Interflon Grease LS1/2
Composition: mixture of mineral oils, calcium-lithium complex thickener, additives and Teflon®.
(working field: from -20°C to +120°C)
- for lubricators and bearing:
WHITE STAR NLGI 0 E 2
Composition: mixture of mineral oils and additives.
(working field: from -30°C to +110°C)
- for chains:
Interflon LUBE EP+
Composition: mixture of mineral and vegetable oils, additives and Teflon®.
Density, 20°C: 0,89 g/cm³
Kinematic viscosity, 20°C (ASTM D2983): 380 mPa.



Before oil replacement, place an oil drip tray in order to avoid the leakage of oil in the environment. Do not disperse the exhausted oil or other consumables in the environment; put them in the appropriate containers and give them to the authorized collection centers.

8.14 ► Indications for the demolition of the MEWP ◀

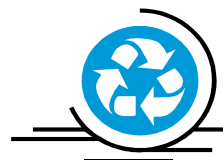

In case of demolition, the machine must be dismantled completely according to the laws in force.



The different types of materials must be destined to the respective authorized centers of collection.

The following material must undergo differentiated disposal therefore placed in suitable places and containers:

- Ferrous materials: carpentries and mechanical components.
- Plastic materials: gaskets, straps, and protections.
- Electrical materials: windings, controls, electro valves and similar.
- Oils and lubricants: hydraulic oil, reducer lubricants, and lubricants greases.

8.15 ► Service ◀

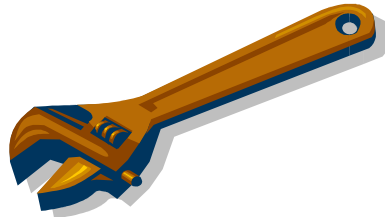

For repairs and maintenance of your platform, refer exclusively to:

**Service
C.M.C. s.r.l.**

Via Bitritto, 119
70124 BARI – ITALY
Tel. **+39 080 5326606**
+39 080 5326557
Fax: **+39 080 5368541**
E-mail: info@cmclift.com



PLEASE NOTICE:

FOR ANY COMMUNICATION, PLEASE SPECIFY MEWP MODEL AND SERIAL NUMBER.

8.15.1 Remote Connection System (*optional)

The remote connection system is composed of an electronic box (Picture 75) mounted on the chassis box.



Picture 75: remote connection system.

Following the remote connection procedure:

1. Ensure that the M12 socket on the remote connection box is correctly connected to the M12 plug of the electric box mounted on the chassis;
2. Share your internet wireless network with the remote connection device in free mode (without password);
3. Lift the connection remote switch on the chassis box:
 - the led on the remote connection box makes two red flashes,
 - after 30 seconds, the led becomes fixed and green, to show that the operating system is working,
 - it automatically hooks up to your free network;
4. Install on your PC the TeamViewer software (11th version) to connect to the machine system, through ID and Password supplied by the manufacturer;
5. Call C.M.C. Service for technical assistance.



9 Troubleshooting



Any operation requiring interventions on the components of the machine, shall be carried out by authorized and trained staff.



Non-authorized staff is not allowed to replace components. **Many components of the MEWP have been calibrated: a correct calibration of these parts (which is possible only in C.M.C. or in authorized repair shops) is necessary to assure the safety of the machine.**

Problem: OUTRIGGERS RED LIGHT DOES NOT TURN ON.

Cause: 1. The MEWP aerial part is not in transport position.
2. The red light does not work.
3. One of the outriggers micro-switches is not working.

Remedies: 1. Place the MEWP aerial part in the transport position.
2. Replace the light.
3. Replace the MEWP supply DPDT relay (double pole double throw).
4. Replacement of micro-switches.

If the problem persists, contact the Service.

Problem: OUTRIGGERS DO NOT WORK.

Cause: 1. The hydraulic pump group is in failure.
2. Outriggers electro valve does not work.

Remedies: 1. Replace hydraulic pump.

If the problem persists, contact the Service.

Problem: WITH THE STABILIZED MEWP, THE GREEN LIGHT DOES NOT TURN ON.

Cause: 1. The green light does not work.
2. Micro-switch system does not work.
3. Stabilization is insufficient.

Remedies: 1. Replace micro-switch.
2. Further extract outriggers.

If the problem persists, contact the Service.

Problem: MEWP AERIAL STRUCTURE DOES NOT WORK WHEN THE OUTRIGGERS CONTROL GREEN LIGHT IS ON.

Cause: 1. The hydraulic pump group is in failure.
2. Emergency button on.

Remedies: 1. Replace the hydraulic pump.
2. Turn the emergency button and reset the MEWP

If the problem persists, contact the Service.

Problem: PLATFORM LEVELLING DOES NOT WORK.

Cause: 1. Oil leakage.
2. Cylinders gaskets wear.

Remedies: 1. Tighten hydraulic connections.
2. Replace gaskets.

If the problem persists, contact the Service.

Problem: OPERATIONS ARE SLOW.

Cause: 1. Pump in failure.
2. Insufficient hydraulic oil.
3. Blocked oil filter.



Remedies: 1. Replace hydraulic pump.
1. Hydraulic oil top up.
2. Filter replacement.

If the problem persists, contact the Service.

Problem: ENGINE START NOT WORKING.

Cause: 1. Emergency button inserted;
2. Discharged battery.

Remedies: 1. Disconnect emergency;
2. Replace battery.

If the problem persists, contact the Service.



Contact our Service Centre for any technical problem which is not identified nor solved by the aforesaid procedures.



10 ►► Sealings list ◀◀

For your information, hereby there is a list of the anti-tampering sealings present on the MEWP:

- emergency bypass;
- electropump activation lever;
- monitored electrovalve;
- proportional valves for aerial part and outriggers.





The tampering or replacement of components by non-authorized staff is strictly forbidden.

→ It is mandatory to restore the sealings after use of these items.



11 ▶▶ Overload tests ◀◀

 During the commissioning of the machine, in the final test, we carried out the following overload tests. During the same, we tested S15 stability and structural resistance.

 Overload tests shall be carried out only on the first test of the machine: these tests are unique. In no other occasion shall you carry out tests with the same loads used in the overload tests.

Overload						
Test n°	Load (Kg)	Boom position			Move-ment	Out-come
		Ray (m)	Boom	//		
1	200 (PN) + 160 (CP)	5,90	Horizontal	//	Lateral	OK
2	200 (PN) + 160 (CP)	5,90	Horizontal	//	lateral	OK

NOTES

PN: nominal capacity.
CP: test load.



12 ▶▶ Operating tests ◀◀



During the commissioning of the machine, we carried out the following final operation tests. We have tested the correct operation of the S15 and of its safety systems.

Test description	Outcome
▪ Block of the operation in case of release of the selected operation lever.	OK
▪ Basket levelling allowed only when the MEWP aerial part is set in the rest position (pantograph on its support and boom on its support).	OK
▪ Manual pump for operations in case of emergency.	OK
▪ Outriggers-boom operation interlock.	OK
▪ MEWP aerial part operations block when the MEWP is not stabilized.	OK
▪ Block of the outriggers return/extension when the aerial part of the MEWP is not set in the rest position.	OK
▪ Machine stabilized - signal light.	OK
▪ MEWP electrical power supply - signal light.	OK
▪ Aerial part consent - signal light	OK
▪ Travel consent - signal light.	OK
▪ Emergency button in the control stations.	OK
▪ Lock valves on cylinders.	OK
▪ Max pressure valves for the protection of the whole hydraulic circuit.	OK
▪ Max pressure valves for the protection of the single parts of the system.	OK
▪ Electrical system protection fuse	OK
▪ Stabilizers extraction - Synchronous control.	OK



13 ▶▶ Control register ◀◀

In this register note down the following events in the machine life:

- Delivery of the MEWP to the first owner (par. 13.1)
- Following ownership transfers (par. 13.2)
- Mechanisms replacements (par. 13.3)
- Replacement of structural elements (par. 13.4)
- Replacement of hydraulic components (par. 13.5)
- Replacement of electrical components (par. 13.6)
- Replacement of safety devices (par. 13.7)
- Considerable failures and relevant repairs (par. 13.8)
- Periodical checks and maintenance journal (par. 13.9)
- Notes (par. 13.10)

13.1 ▶ Delivery of the MEWP to the first owner ◀

cmc[®]
AERIAL PLATFORM S

The mobile elevating work platform
brand **CMC**
model **S15**
serial number **S19A2138**
manufacture year **2020**

has been delivered by **CMC s.r.l.**

to the firm
Duma Rent BVBA
Torkonjestraat 23 8510 Marke Belgium

according to the contractual conditions
established with the technical, dimensional and
functional features, as indicated in the
use and maintenance manual.

date 30/01/20

CMC s.r.l.



13.3 ▶ Mechanisms replacement ◀

Description of the component.....

Manufacturer.....

Provided by.....

Cause of the replacement.....

.....

Place..... Date.....

Stamp and signature of the responsible
for the firm in charge

The user

Description of the component.....

Manufacturer.....

Provided by.....

Cause of the replacement.....

.....

Place..... Date.....

Stamp and signature of the responsible
for the firm in charge

The user

Description of the component.....

Manufacturer.....

Provided by.....

Cause of the replacement.....

.....

Place..... Date.....

Stamp and signature of the responsible
for the firm in charge

The user

Description of the component.....

Manufacturer.....

Provided by.....

Cause of the replacement.....

.....

Place..... Date.....

Stamp and signature of the responsible
for the firm in charge

The user



13.4 ▶ Replacement of structural elements ◀

Description of the component.....

Manufacturer.....

Provided by.....

Cause of the replacement.....

.....

Place..... Date.....

Stamp and signature of the responsible
for the firm in charge

The user

Description of the component.....

Manufacturer.....

Provided by.....

Cause of the replacement.....

.....

Place..... Date.....

Stamp and signature of the responsible
for the firm in charge

The user

Description of the component.....

Manufacturer.....

Provided by.....

Cause of the replacement.....

.....

Place..... Date.....

Stamp and signature of the responsible
for the firm in charge

The user

Description of the component.....

Manufacturer.....

Provided by.....

Cause of the replacement.....

.....

Place..... Date.....

Stamp and signature of the responsible
for the firm in charge

The user



13.5 ▶ Replacement of hydraulic components ◀

Description of the component.....
 Manufacturer.....
 Provided by.....
 Cause of the replacement.....

 Place..... Date.....
 Stamp and signature of the responsible
 for the firm in charge The user

Description of the component.....
 Manufacturer.....
 Provided by.....
 Cause of the replacement.....

 Place..... Date.....
 Stamp and signature of the responsible
 for the firm in charge The user

Description of the component.....
 Manufacturer.....
 Provided by.....
 Cause of the replacement.....

 Place..... Date.....
 Stamp and signature of the responsible
 for the firm in charge The user

Description of the component.....
 Manufacturer.....
 Provided by.....
 Cause of the replacement.....

 Place..... Date.....
 Stamp and signature of the responsible
 for the firm in charge The user



13.6 ▶ Replacement of electrical components ◀

Description of the component.....
 Manufacturer.....
 Provided by.....
 Cause of the replacement.....

 Place..... Date.....
 Stamp and signature of the responsible
 for the firm in charge The user

Description of the component.....
 Manufacturer.....
 Provided by.....
 Cause of the replacement.....

 Place..... Date.....
 Stamp and signature of the responsible
 for the firm in charge The user

Description of the component.....
 Manufacturer.....
 Provided by.....
 Cause of the replacement.....

 Place..... Date.....
 Stamp and signature of the responsible
 for the firm in charge The user

Description of the component.....
 Manufacturer.....
 Provided by.....
 Cause of the replacement.....

 Place..... Date.....
 Stamp and signature of the responsible
 for the firm in charge The user



13.7 ▶ Replacement of safety devices ◀

Description of the component.....
 Manufacturer.....
 Provided by.....
 Cause of the replacement.....

 Place..... Date.....
 Stamp and signature of the responsible
 for the firm in charge The user

Description of the component.....
 Manufacturer.....
 Provided by.....
 Cause of the replacement.....

 Place..... Date.....
 Stamp and signature of the responsible
 for the firm in charge The user

Description of the component.....
 Manufacturer.....
 Provided by.....
 Cause of the replacement.....

 Place..... Date.....
 Stamp and signature of the responsible
 for the firm in charge The user

Description of the component.....
 Manufacturer.....
 Provided by.....
 Cause of the replacement.....

 Place..... Date.....
 Stamp and signature of the responsible
 for the firm in charge The user



13.8 ▶ Considerable failures and relevant repairs ◀

Description of the failure.....

.....
.....

Cause.....

.....
.....

Repairs performed

.....
.....

Place..... Date.....

Stamp and signature of the responsible
for the firm in charge

The user

Description of the failure.....

.....
.....

Cause.....

.....
.....

Repairs performed

.....
.....

Place..... Date.....

Stamp and signature of the responsible
for the firm in charge

The user



13.9 ▶ Periodical checks and maintenance journal ◀

➔ The user shall observe the maintenance and control program described in this manual.

DATE	DESCRIPTION OF THE INTERVENTION	SIGNATURE

DATE	DESCRIPTION OF THE INTERVENTION	SIGNATURE



DATE	DESCRIPTION OF THE INTERVENTION	SIGNATURE	DATE	DESCRIPTION OF THE INTERVENTION	SIGNATURE



13.10 ▶ Notes



.....

.....

.....

.....

.....

.....

.....

.....

.....

.....

.....

.....

.....

.....

.....

.....

.....

.....

.....

.....

.....

.....

.....

.....

.....

.....

.....

.....

.....

.....

.....

.....

.....

.....

.....

.....

.....

.....

.....

.....

.....

.....

.....

.....



▶▶ Index ◀◀

0 ▶▶ Introduction ◀◀ 1

- 0.1 ▶ Content of the manual ◀ 1
- 0.2 ▶ Disclaimer ◀ 2
- 0.3 ▶ Where and how to store the manual ◀ 2
- 0.4 ▶ Regulatory references ◀ 2
- 0.5 ▶ Amendments and integrations ◀ 3

1 ▶▶ Specifications ◀◀ 4

- 1.1 ▶ Technical sheet ◀ 4
- 1.2 ▶ Identification plate ◀ 6
- 1.3 ▶ CE certification ◀ 7
- 1.4 ▶ TÜV certification ◀ 7
- 1.5 ▶ Classification ◀ 7
- 1.6 ▶ Loading cycles ◀ 7
- 1.7 ▶ Working diagram ◀ 8

2 ▶▶ Description and purpose ◀◀ 9

- 2.1 ▶ Definition ◀ 9
- 2.2 ▶ Machine purpose ◀ 9
- 2.3 ▶ Description of the main components ◀ 10

3 ▶▶ Control positions ◀◀ 12

- 3.1 ▶ Machine switching on/off station ◀ 12
- 3.2 ▶ Platform control stations ◀ 13

4 ▶▶ Use procedures ◀◀ 20

- 4.1 ▶ Environmental exercise conditions ◀ 20
- 4.2 ▶ Safety distances ◀ 21
- 4.3 ▶ Transport, storage and package ◀ 21
- 4.4 ▶ MEWP use procedures ◀ 22
- 4.5 ▶ Battery pack recharge ◀ 25
- 4.6 ▶ Emergency operations ◀ 26
- 4.7 ▶ Safety rules ◀ 28
- 4.8 ▶ Safety devices ◀ 32

5 ▶▶ Markings ◀◀ 33

6 ▶▶ Electrical system ◀◀ 45

7 ▶▶ Hydraulic system ◀◀ 46

8 ▶▶ Maintenance ◀◀ 47

- 8.1 ▶ Daily maintenance ◀ 47
- 8.2 ▶ Weekly maintenance (or every 40 hours) ◀ 49
- 8.3 ▶ Monthly maintenance (or every 120 hours) ◀ 49
- 8.4 ▶ Quarterly maintenance (or every 300 hours) ◀ 50
- 8.5 ▶ Maintenance after the first 400 hours ◀ 50
- 8.6 ▶ Six-monthly maintenance (or every 750 hours) ◀ 50
- 8.7 ▶ Annual maintenance (or every 1500 hours) ◀ 50
- 8.8 ▶ Biennial maintenance ◀ 50
- 8.9 ▶ Five-yearly maintenance ◀ 50
- 8.10 ▶ Safety rules during maintenance ◀ 51
- 8.11 ▶ Maintenance of endothermic engine ◀ 51
- 8.12 ▶ Maintenance of 48 V electric engine (*optional) ◀ 52
- 8.13 ▶ Consumables ◀ 52
- 8.14 ▶ Indications for the demolition of the MEWP ◀ 53
- 8.15 ▶ Service ◀ 53

9 ▶▶ Troubleshooting ◀◀ 55

10 ▶▶ Sealings list ◀◀ 57

11 ▶▶ Overload tests ◀◀ 58

12 ▶▶ Operating tests ◀◀ 59

13 ▶▶ Control register ◀◀ 60

- 13.1 ▶ Delivery of the MEWP to the first owner ◀ 60
- 13.2 ▶ Following ownership transfers ◀ 61
- 13.3 ▶ Mechanisms replacement ◀ 62
- 13.4 ▶ Replacement of structural elements ◀ 63
- 13.5 ▶ Replacement of hydraulic components ◀ 64
- 13.6 ▶ Replacement of electrical components ◀ 65
- 13.7 ▶ Replacement of safety devices ◀ 66
- 13.8 ▶ Considerable failures and relevant repairs ◀ 67
- 13.9 ▶ Periodical checks and maintenance journal ◀ 68
- 13.10 ▶ Notes ◀ 70