



Bobcat®

EN

Operation & Maintenance Manual T110 Compact Track Loader

S/N AE0J11001 & Above

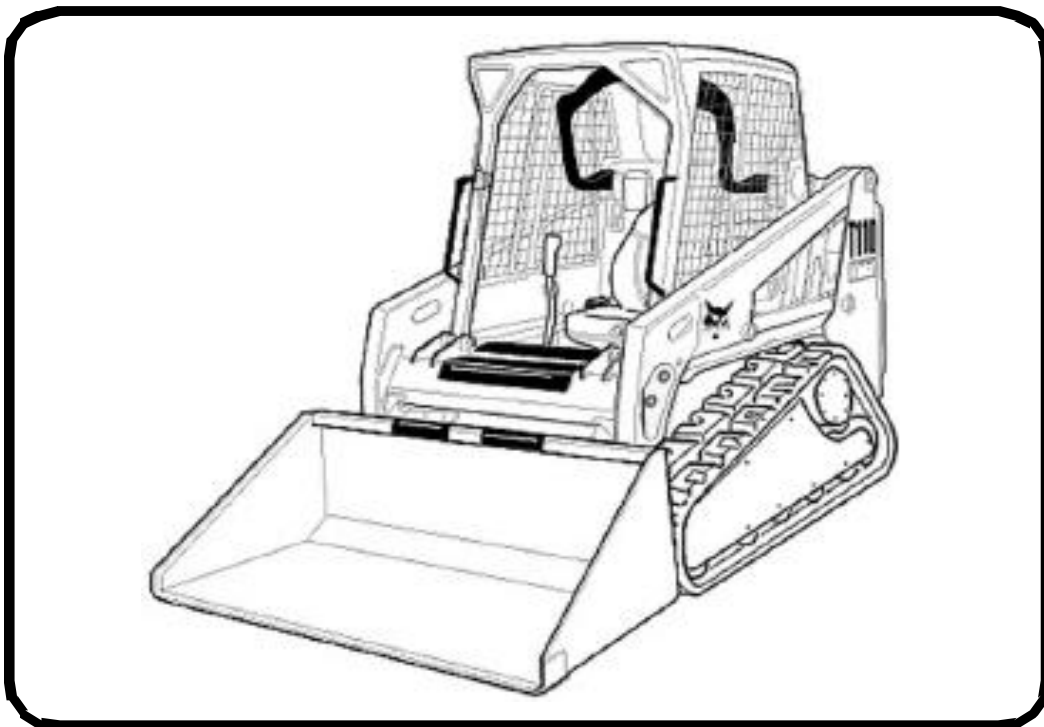

**EQUIPPED WITH
BOBCAT INTERLOCK
CONTROL SYSTEM (BICS™)**





OPERATOR SAFETY WARNINGS

WARNING

Operator must have instructions before operating the machine. Untrained operators can cause injury or death.

W-2001-0502

CORRECT

P-90216

⚠ Never use the loader without instructions. See machine signs (decals), Operation & Maintenance Manual, and Operator's Handbook.

⚠ **Safety Alert Symbol:** This symbol with a warning statement, means: "Warning, be alert! Your safety is involved!" Carefully read the message that follows.

CORRECT

B-15570

⚠ Always use the seat bar and fasten seat belt snugly.
⚠ Always keep feet on the foot pedals or footrests when operating loader.

CORRECT

B-15652

⚠ Never use loader without operator cab with ROPS and FOPS approval. Fasten your seat belt.

WRONG

B-15653

⚠ Never use loader as man lift or elevating device for personnel.

WRONG

B-15260

⚠ Do not use loader in atmosphere with explosive dust, explosive gas, or where exhaust can contact flammable material.

WRONG

B-15654

⚠ Never carry riders.
⚠ Keep bystanders away from work area.

WRONG

B-15655

⚠ Always carry bucket or attachments as low as possible.
⚠ Do not travel or turn with lift arms up.
⚠ Load, unload, and turn on flat level ground.

WRONG

B-15656

⚠ Never exceed Rated Operating Capacity.

WRONG

B-15657

⚠ Never leave loader with engine running or with lift arms up.
⚠ To park, engage parking brake and put attachment flat on the ground.

WRONG

B-15658

⚠ Never modify equipment.
⚠ Use only attachments approved by Bobcat Company for this model loader.

SAFETY EQUIPMENT

The Bobcat Loader must be equipped with safety items necessary for each job. Ask your dealer for information on the safe use of attachments and accessories.

1. SEAT BELT: Check belt fasteners and check for damaged webbing or buckle.
2. SEAT BAR: When up, it must lock the loader controls.
3. OPERATOR CAB (ROPS and FOPS): It must be on the loader with all fasteners tight.
4. OPERATOR'S HANDBOOK: Must be in the cab.
5. SAFETY SIGNS (DECALS): Replace if damaged.
6. SAFETY TREADS: Replace if damaged.
7. GRAB HANDLES: Replace if damaged.
8. LIFT ARM SUPPORT DEVICE: Replace if damaged.
9. PARKING BRAKE
10. BOBCAT INTERLOCK CONTROL SYSTEM (BICS)

OSW10-0409



Bobcat®



CONTENTS

FOREWORD	5
SAFETY & TRAINING RESOURCES	17
OPERATING INSTRUCTIONS	29
PREVENTIVE MAINTENANCE	99
SYSTEM SETUP & ANALYSIS	149
SPECIFICATIONS	163
WARRANTY	171
ALPHABETICAL INDEX	175

REFERENCE INFORMATION

Write the correct information for YOUR Bobcat loader in the spaces below. Always use these numbers when referring to your Bobcat loader.

Loader Serial Number _____
Engine Serial Number _____

NOTES:

YOUR BOBCAT DEALER:

ADDRESS:

PHONE:



Bobcat Company
P.O. Box 128
Gwinner, ND 58040-0128
UNITED STATES OF AMERICA

Doosan Benelux SA
Drève Richelle 167
B-1410 Waterloo
BELGIUM



Bobcat®



FOREWORD

This Operation & Maintenance Manual was written to give the owner / operator instructions on the safe operation and maintenance of the Bobcat loader. READ AND UNDERSTAND THIS OPERATION & MAINTENANCE MANUAL BEFORE OPERATING YOUR BOBCAT LOADER. If you have any questions, see your Bobcat dealer. This manual may illustrate options and accessories not installed on your loader.

DECLARATION OF CONFORMITY	7
BOBCAT COMPANY IS ISO 9001 CERTIFIED	9
REGULAR MAINTENANCE ITEMS	9
LUBRICANTS AND FLUIDS	10
SERIAL NUMBER LOCATIONS	11
Loader Serial Number	11
Engine Serial Number	11
DELIVERY REPORT	11
LOADER IDENTIFICATION	12
FEATURES, ACCESSORIES AND ATTACHMENTS	13
Standard Items	13
Options And Accessories	13
Buckets Available	14
Attachments	14
Special Applications Kit	15
Special Applications Kit Inspection And Maintenance	15



Bobcat®



DECLARATION OF CONFORMITY

Contents of EC Declaration of Conformity

This information is provided in the operators manual to comply with clause 1.7.4.2(c) of Annex I of Machinery Directive 2006/42/EC.

The official EC Declaration of Conformity is supplied in a separate document.

<p>Manufacturer</p>  <p>Bobcat[®]</p> <p>Bobcat Company World Headquarters 250 East Beaton Drive West Fargo, ND 58078-6000 UNITED STATES OF AMERICA</p>	<p>Directive 2000/14/EC: Noise Emission in the Environment by Equipment For Use Outdoors</p> <p>Notified Body Technical and Test Institute for Construction Prague, Czech Republic Notified Body Number: 1020</p>				
<p>Technical Documentation Doosan Benelux SA Drève Richelle 167 B-1410 Waterloo BELGIUM</p>	<p>EC Certificate No. 1020-090-022395</p> <p>Conformity Assessment Procedure(s) 2000/14/EC, Annex VIII, Full Quality Assurance</p> <p>Sound Power Levels [Lw(A)]</p> <table data-bbox="836 1126 1436 1187"> <tr> <td>Measured Sound Power</td> <td>99dBA</td> </tr> <tr> <td>Guaranteed Sound Power</td> <td>101dBA</td> </tr> </table>	Measured Sound Power	99dBA	Guaranteed Sound Power	101dBA
Measured Sound Power	99dBA				
Guaranteed Sound Power	101dBA				
<p>Description of Equipment Type of Equipment: Crawler Loader Model Name: T110 Model Code: AE0J</p> <p>Engine Manufacturer: Kubota Engine Model: V2403-M-DI-EU37 Engine Power: 30,7 kW @ 2200 rpm</p>	<p>Equipment conforms to CE Directive(s) Listed Below 2006/42/EC: Machinery Directive 2004/108/EC: Electromagnetic Compatibility Directive</p>				
<p>Declaration of Conformance This equipment conforms to the requirements specified in all the EC Directives listed in this declaration.</p>					
<p>Effective From: 29 December 2009</p>					



Bobcat®



BOBCAT COMPANY IS ISO 9001 CERTIFIED











ISO 9001 is an international standard that specifies requirements for a quality management system that controls the processes and procedures which we use to design, develop, manufacture and distribute Bobcat products.

British Standards Institute (BSI) is the Certified Registrar Bobcat Company chose to assess the Company's compliance with the ISO 9001 at Bobcat's manufacturing facilities in Gwinner and Bismarck, North Dakota (U.S.A.), Pontchateau (France), Dobris (Czech Republic) and the Bobcat corporate offices (Gwinner, Bismarck & West Fargo) in North Dakota. Only certified assessors, like BSI, can grant registrations.

ISO 9001 means that as a company we say what we do and do what we say. In other words, we have established procedures and policies, and we provide evidence that the procedures and policies are followed.

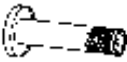
REGULAR MAINTENANCE ITEMS

	ENGINE OIL FILTER (6 Pack) 6657635		HYDRAULIC CHARGE FILTER 6681012
	FUEL FILTER 6667352		HYDROSTATIC FILTER 6661248
	AIR FILTER, Outer 6690907		BATTERY 6674687
	AIR FILTER, Inner 6690908		
	CASE DRAIN FILTER, In-Line 6661022		HYDRAULIC FILL / BREATHER CAP 6727475

NOTE: Always verify Part Numbers with your Bobcat dealer.

SERIAL NUMBER LOCATIONS

Always use the serial number of the loader when requesting service information or when ordering parts. Early or later models (identification made by serial number) may use different parts, or it may be necessary to use a different procedure in doing a specific service operation.

Figure 1



Loader Serial Number

The loader serial number plate [Figure 1] is located inside the cab on the right-hand side.

Explanation of loader Serial Number:

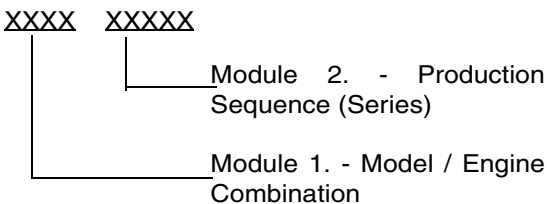

1. The four digit Model / Engine Combination Module number identifies the model number and engine combination.

2. The five digit Production Sequence Number identifies the order which the loader is produced.

Engine Serial Number

Figure 2

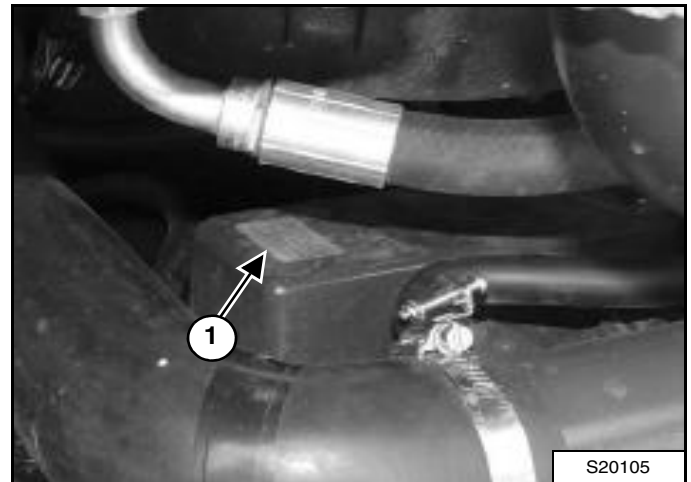

The engine serial number is located on top of the engine (Item 1) [Figure 2].

DELIVERY REPORT

Figure 3

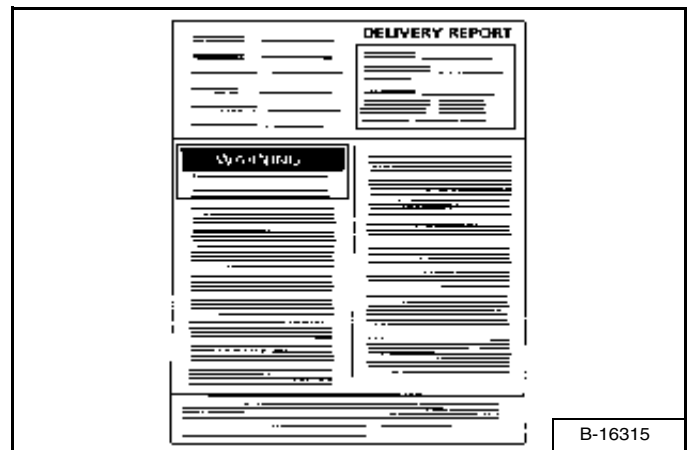

The delivery report [Figure 3] must be completed by the dealer and signed by the owner or operator when the Bobcat loader is delivered. An explanation of the form must be given to the owner.

LOADER IDENTIFICATION

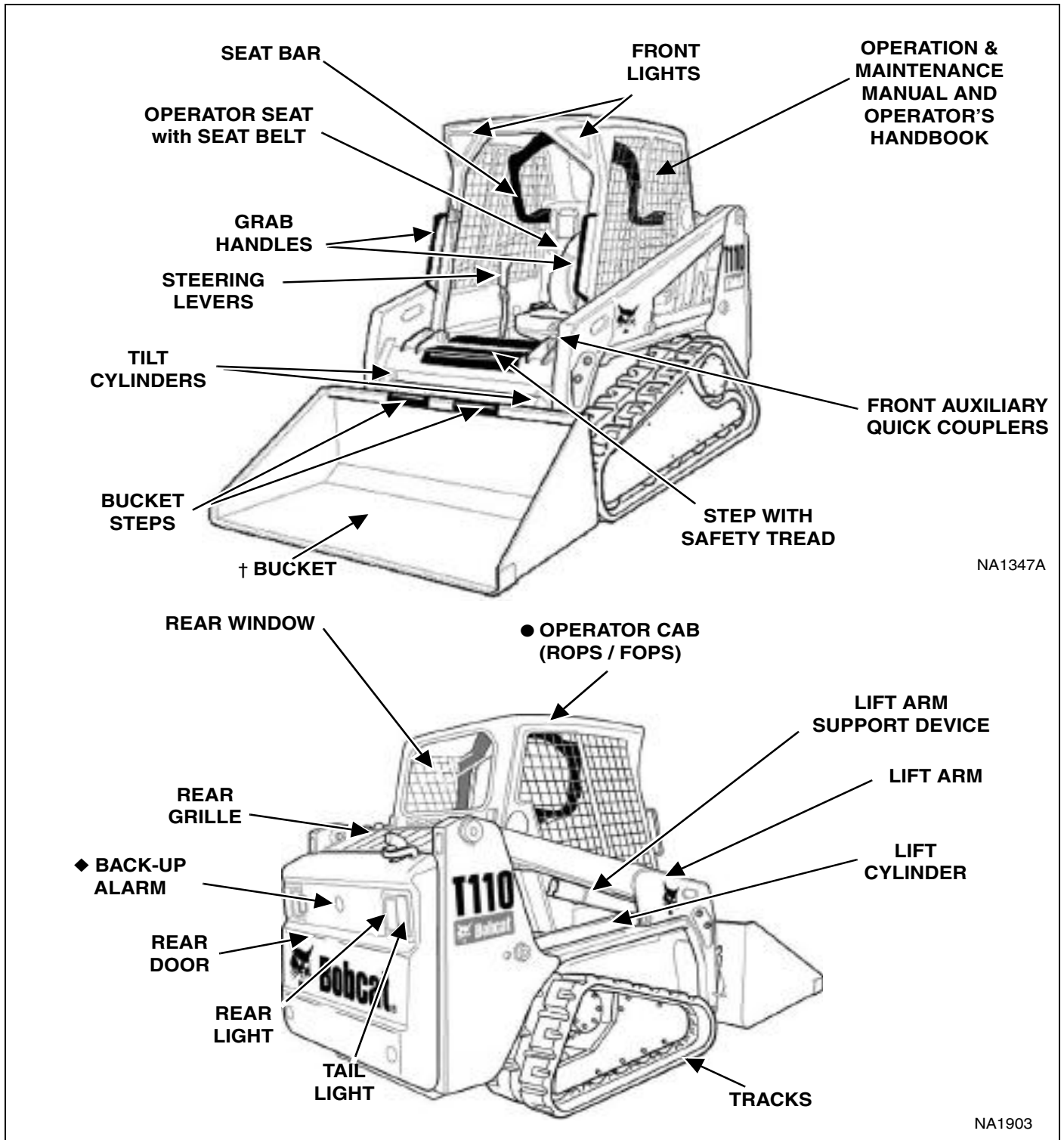

NA1347A

NA1903

◆ Optional or Field Accessory (Not Standard Equipment)

† Bucket - Several different buckets and other attachments are available for this machine.

● ROPS, FOPS - Roll Over Protective Structure, per ISO 3471, and Falling Object Protective Structure per ISO 3449, Level I. Level II is available.



FEATURES, ACCESSORIES AND ATTACHMENTS

Standard Items

Model T110 Bobcat loaders are equipped with the following standard items:

- Adjustable Vinyl Suspension Seat
- Automatically Activated Glow Plugs
- Auxiliary Hydraulics (Variable Flow / Continuous Flow)
- Bobcat Interlock Control System (BICS™)
- Bob-Tach™
- CE Certification
- Deluxe Cab (includes: interior insulation, top, rear and side windows, accessory harness, dome light and 12 volt power port) ROPS and FOPS Approved
- Engine / Hydraulic Systems Shutdown
- Front Cab Door with Windshield Wiper
- Front Horn
- Hydraulic Bucket Positioning (Includes On / Off Selection)
- Instrumentation: Hourmeter, Engine Temperature and Fuel Gauges and Warning Lights
- Lift Arm Support Device
- Lights, Front and Rear
- Parking Brake
- Seat Bar
- Seat Belt
- Sound Cab (Reduces noise at operator ear)
- Sound Insulation (Reduces noise to bystanders)
- Spark arrester Muffler
- Tailgate Lock
- Tool Container
- Tracks, Rubber - 250 mm (9.8 in)

Options And Accessories

Below is a list of some equipment available from your Bobcat loader dealer as Dealer and / or Factory Installed Accessories and Factory Installed Options. See your Bobcat dealer for other available options and accessories.

- Access Cover Kit (Foot Pedal Area)
- Adjustable Air Ride Suspension Seat
- Attachment Control Device (ACD)
- Back-up Alarm
- Bucket Shields
- Cab Heater
- Catalytic Exhaust Purifier
- Deluxe Hand Controls
- Deluxe Instrumentation Panel
- Dual Attachment Control Kit
- Dual Steering Damper
- Fire Extinguisher
- FOPS Kit (Level II)
- Fuel Sediment Bowl Kit
- Hose Guide
- Keyless Start
- Lift Kit (Single-Point)
- Locking Fuel Cap
- Power Bob-Tach
- Rear Window Wiper
- Road Kit
- Road Option
- Rotating Beacon
- Seat Belt with 3-Point Restraint
- Seat Belt - 3 in. Wide
- Seat Belt - Retractable
- Selectable Joystick Controls (SJC) (Selectable 'ISO' or 'H' Pattern Control)
- Special Applications Kit
- Strobe Light
- Two-Speed Travel (Only available with SJC controls)
- Vinyl Cab Enclosure
- Warning Lights: Four-Way Flasher (Includes Direction Signals)
- Windows:
 - Externally Removable Rear Window
 - Polycarbonate Rear Window
 - Polycarbonate Top Window

Specifications subject to change without notice and standard items may vary.



**FEATURES, ACCESSORIES AND ATTACHMENTS
(CONT'D)**

These and other attachments are approved for use on this model loader. Do not use unapproved attachments. Attachments not manufactured by Bobcat may not be approved.

The versatile Bobcat loader quickly turns into a multi-job machine with a tight-fit attachment hook-up . . . from bucket to grapple to pallet fork to backhoe and a variety of other attachments.

See your Bobcat dealer for information about approved attachments and attachment Operation & Maintenance Manuals.

Increase the versatility of your Bobcat loader with a variety of bucket styles and sizes.

Buckets Available

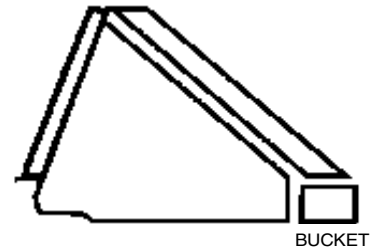

Many bucket styles, widths and different capacities are available for a variety of different applications. They include Construction & Industrial, Low Profile, Fertilizer and Snow, to name a few. See your Bobcat dealer for the correct bucket for your Bobcat loader and application.

Attachments

- Angle Broom
- Auger
- Backhoe
- Blades
 - Snow Blade
 - V-Blade
- Breaker, Hydraulic
- Brush Saw
- Buckets
- Digger
- Dumping Hopper
- Forks, Utility
- Grapple, Farm / Utility
- Landplane
- Mower
- Pallet Forks
- Scarifier
- Scraper
- Snowblower
- Soil Conditioner
- Sweeper
- Three-Point Hitch Adapter
- Tiller
- Trencher
- Utility Frame
- X-Change™ Frame

**FEATURES, ACCESSORIES AND ATTACHMENTS
(CONT'D)**

Special Applications Kit



AVOID INJURY OR DEATH

Some attachment applications can cause flying debris or objects to enter front, top or rear cab openings. Install the Special Applications Kit to provide added operator protection in these applications.

W-2737-0508

Figure 4

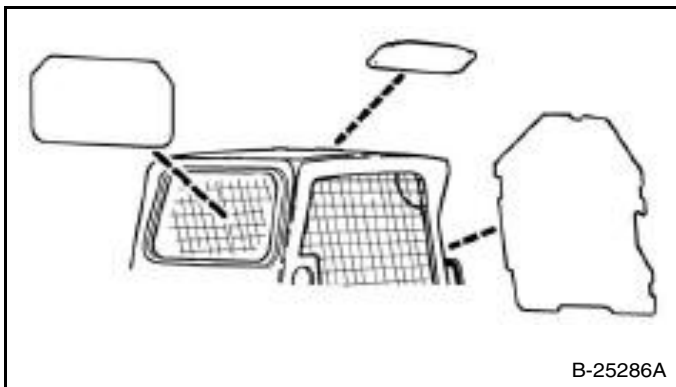

Available for special applications to restrict material from entering cab openings. Kit includes 12,7 mm (0.5 in) thick polycarbonate front door, top and rear windows [Figure 4].

See your Bobcat dealer for availability.

Special Applications Kit Inspection And Maintenance

- Inspect for cracks or damage. Replace if required.
- Pre-rinse with water to remove gritty materials.
- Wash with a mild household detergent and warm water.
- Use a sponge or soft cloth. Rinse well with water and dry with a clean soft cloth or rubber squeegee.
- Do not use abrasive or highly alkaline cleaners.
- Do not clean with metal blades or scrapers.



Bobcat®



SAFETY & TRAINING RESOURCES

SAFETY INSTRUCTIONS	19
Before Operation	19
Safe Operation Is The Operator's Responsibility	20
Safe Operation Needs A Qualified Operator	20
Avoid Silica Dust	21
FIRE PREVENTION	21
Maintenance	21
Operation	21
Electrical	21
Hydraulic System	22
Fueling	22
Starting	22
Spark Arrester Exhaust System	22
Welding And Grinding	22
Fire Extinguishers	22
MACHINE SIGNS (DECALS)	24
No-Text Safety Signs	26
PUBLICATIONS AND TRAINING RESOURCES	28



Bobcat®



SAFETY INSTRUCTIONS

Before Operation

Carefully follow the operating and maintenance instructions in this manual.

The Bobcat loader is highly maneuverable and compact. It is rugged and useful under a wide variety of conditions. This presents an operator with hazards associated with off motorway, rough terrain applications, common with Bobcat loader usage.

The Bobcat loader has an internal combustion engine with resultant heat and exhaust. All exhaust gases can kill or cause illness so use the Loader with adequate ventilation.

The dealer explains the capabilities and restrictions of the Bobcat loader and attachment for each application. The dealer demonstrates the safe operation according to Bobcat instructional materials, which are also available to operators. The dealer can also identify unsafe modifications or use of unapproved attachments. The attachments and buckets are designed for a Rated Operating Capacity (some have restricted lift heights). They are designed for secure fastening to the Bobcat loader. The user must check with the dealer, or Bobcat literature, to determine safe loads of materials of specified densities for the machine - attachment combination.

The following publications and training materials provide information on the safe use and maintenance of the Bobcat machine and attachments:

- The Delivery Report is used to assure that complete instructions have been given to the new owner and that the machine and attachment is in safe operating condition.
- The Operation & Maintenance Manual delivered with the machine or attachment gives operating information as well as routine maintenance and service procedures. It is a part of the machine and can be stored in a container provided on the machine. Replacement Operation & Maintenance Manuals can be ordered from your Bobcat dealer.
- Machine signs (decals) instruct on the safe operation and care of your Bobcat machine or attachment. The signs and their locations are shown in the Operation & Maintenance Manual. Replacement signs are available from your Bobcat dealer.
- An Operator's Handbook is fastened to the operator cab of the loader. Its brief instructions are convenient to the operator. See your Bobcat dealer for more information on translated versions.

The dealer and owner / operator review the recommended uses of the product when delivered. If the owner / operator will be using the machine for a different application(s) he or she must ask the dealer for recommendations on the new use.

SAFETY INSTRUCTIONS (CONT'D)

Safe Operation Is The Operator's Responsibility

Safety Alert Symbol

This symbol with a warning statement means:
"Warning, be alert! Your safety is involved!"
Carefully read the message that follows.

WARNING

Operator must have instructions before operating the machine. Untrained operators can cause injury or death.

W-2001-0502

IMPORTANT

This notice identifies procedures which must be followed to avoid damage to the machine.

I-2019-0284

DANGER

The signal word DANGER on the machine and in the manuals indicates a hazardous situation which, if not avoided, will result in death or serious injury.

D-1002-1107

WARNING

The signal word WARNING on the machine and in the manuals indicates a potentially hazardous situation which, if not avoided, could result in death or serious injury.

W-2044-1107

The Bobcat loader and attachment must be in good operating condition before use.

Check all of the items on the Bobcat Service Schedule Decal under the 8-10 hour column or as shown in the Operation & Maintenance Manual.

Safe Operation Needs A Qualified Operator

For an operator to be qualified, he or she must not use drugs or alcoholic drinks which impair alertness or coordination while working. An operator who is taking prescription drugs must get medical advice to determine if he or she can safely operate a machine.

A Qualified Operator Must Do The Following:

Understand the Written Instructions, Rules and Regulations

- The written instructions from Bobcat Company include the Delivery Report, Operation & Maintenance Manual, Operator's Handbook and machine signs (decals).
- Check the rules and regulations at your location. The rules may include an employer's work safety requirements. For driving on public roads, the machine must be equipped as stipulated by the local regulations authorising operation on public roads in your specific country. Regulations may identify a hazard such as a utility line.

Have Training with Actual Operation

- Operator training must consist of a demonstration and verbal instruction. This training is given by your Bobcat dealer before the product is delivered.
- The new operator must start in an area without bystanders and use all the controls until he or she can operate the machine and attachment safely under all conditions of the work area. Always fasten seat belt before operating.

Know the Work Conditions

- Know the weight of the materials being handled. Avoid exceeding the Rated Operating Capacity (ROC) of the machine. Material which is very dense will be heavier than the same volume of less dense material. Reduce the size of the load if handling dense material.
- The operator must know any prohibited uses or work areas, for example, he or she needs to know about excessive slopes.
- Know the location of any underground lines.
- Wear tight fitting clothing. Always wear safety glasses when doing maintenance or service. Safety glasses, respiratory equipment, hearing protection or Special Applications Kits are required for some work. See your Bobcat dealer about Bobcat Safety Equipment for your model.

SAFETY INSTRUCTIONS (CONT'D)

Avoid Silica Dust



Cutting or drilling concrete containing sand or rock containing quartz may result in exposure to silica dust. Use a respirator, water spray or other means to control dust.

FIRE PREVENTION



Maintenance

The machine and some attachments have components that are at high temperatures under normal operating conditions. The primary source of high temperatures is the engine and exhaust system. The electrical system, if damaged or incorrectly maintained, can be a source of arcs or sparks.

Flammable debris (leaves, straw, etc.) must be removed regularly. If flammable debris is allowed to accumulate, it can cause a fire hazard. Clean often to avoid this accumulation. Flammable debris in the engine compartment is a potential fire hazard.

The operator's area, engine compartment and engine cooling system must be inspected every day and cleaned if necessary to prevent fire hazards and overheating.

All fuels, most lubricants and some coolants mixtures are flammable. Flammable fluids that are leaking or spilled onto hot surfaces or onto electrical components can cause a fire.

Operation

Do not use the machine where exhaust, arcs, sparks or hot components can contact flammable material, explosive dust or gases.

Electrical



Check all electrical wiring and connections for damage. Keep the battery terminals clean and tight. Repair or replace any damaged part or wires that are loose or frayed.

Battery gas can explode and cause serious injury. Use the procedure in the Operation & Maintenance Manual for connecting the battery and for jump starting. Do not jump start or charge a frozen or damaged battery. Keep any open flames or sparks away from batteries. Do not smoke in battery charging area.



FIRE PREVENTION (CONT'D)

Hydraulic System

Check hydraulic tubes, hoses and fittings for damage and leakage. Never use open flame or bare skin to check for leaks. Hydraulic tubes and hoses must be properly routed and have adequate support and secure clamps. Tighten or replace any parts that show leakage.

Always clean fluid spills. Do not use petrol or diesel fuel for cleaning parts. Use commercial non-flammable solvents.

Fueling



Stop the engine and let it cool before adding fuel. No smoking! Do not refuel a machine near open flames or sparks. Fill the fuel tank outdoors.

Starting

Do not use ether or starting fluids on any engine that has glow plugs or air intake heater. These starting aids can cause explosion and injure you or bystanders.

Use the procedure in the Operation & Maintenance Manual for connecting the battery and for jump starting.

Spark Arrester Exhaust System

The spark arrester exhaust system is designed to control the emission of hot particles from the engine and exhaust system, but the muffler and the exhaust gases are still hot.

Check the spark arrester exhaust system regularly to make sure it is maintained and working properly. Use the procedure in the Operation & Maintenance Manual for cleaning the spark arrester muffler (if equipped).

Welding And Grinding

Always clean the machine and attachment, disconnect the battery, and disconnect the wiring from the Bobcat controllers before welding. Cover rubber hoses, battery and all other flammable parts. Keep a fire extinguisher near the machine when welding.

Have good ventilation when grinding or welding painted parts. Wear dust mask when grinding painted parts. Toxic dust or gas can be produced.

Dust generated from repairing non-metallic parts such as hoods, fenders or covers can be flammable or explosive. Repair such components in a well ventilated area away from open flames or sparks.

Fire Extinguishers

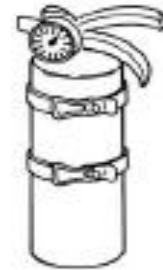

Know where fire extinguishers and first aid kits are located and how to use them. Inspect the fire extinguisher and service the fire extinguisher regularly. Obey the recommendations on the instructions plate.



Bobcat®



MACHINE SIGNS (DECALS)

Follow the instructions on all the Machine Signs (Decals) that are on the loader. Replace any damaged machine signs and be sure they are in the correct locations. Machine signs are available from your Bobcat loader dealer.

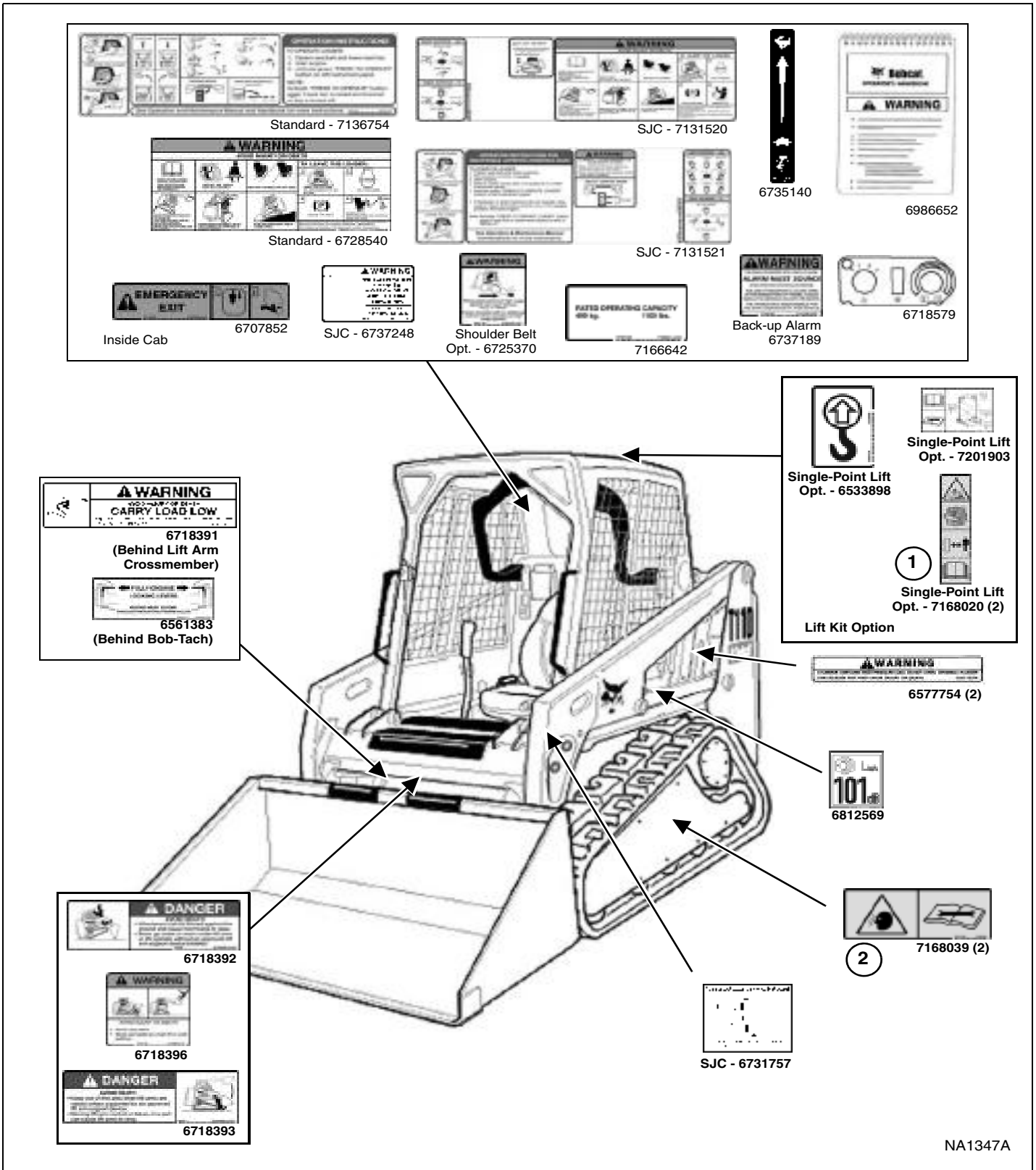



MACHINE SIGNS (DECALS) (CONT'D)

Follow the instructions on all the Machine Signs (Decals) that are on the loader. Replace any damaged machine signs and be sure they are in the correct locations. Machine signs are available from your Bobcat Loader dealer.

6565990
BOBCAT HYDRAULIC FLUID

6560573
IMPORTANT

7169699
3

Under Rear Grille

6726303
(Externally Removable Rear Window only)

6577754 (2)
WARNING

6578368
PUSH TO RELEASE STOP

6713507 (2)
4

6706558

6809511 (4)
(On Hose & Tubeline)

6717343 (2)
DANGER

6727595 (3)

6734534
Inside Rear Door

7159779
(Inside Fuse Cover)

NA1903

MACHINE SIGNS (DECALS) (CONT'D)

No-Text Safety Signs

Safety signs are used to alert the equipment operator or maintenance person to hazards that may be encountered in the use and maintenance of the equipment. The location and description of the safety signs are detailed in this section. Please become familiarized with all safety signs installed on the machine / attachment.

Vertical Configuration

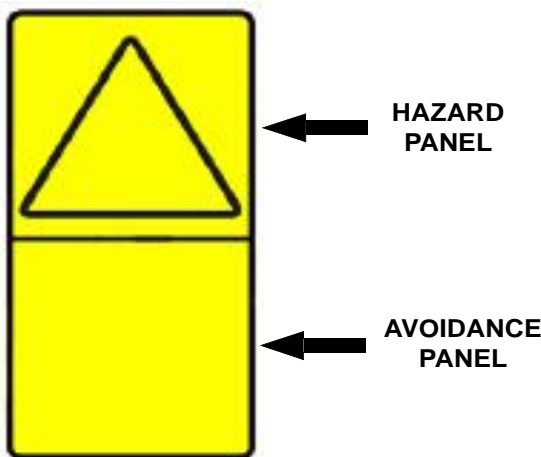

Horizontal Configuration

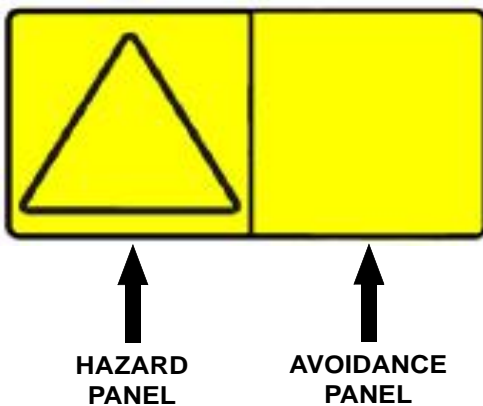

The format consists of the hazard panel(s) and the avoidance panel(s):

Hazard panels depict a potential hazard enclosed in a safety alert triangle.

Avoidance panels depict actions required to avoid the hazards.

A safety sign may contain more than one hazard panel and more than one avoidance panel.

NOTE: See the numbered MACHINE SIGNS (DECALS) on Page 24 and MACHINE SIGNS (DECALS) (CONT'D) on Page 25 for the machine location of each correspondingly numbered no-text decal.

1. Single-Point Lift (7168020)

This safety sign is located on the side arm of the single-point lift.



**FAILURE OF THE LIFT ASSEMBLY CAN CAUSE
SERIOUS INJURY OR DEATH**

BEFORE LIFTING LOADER:

1. Check the hardware and fasteners at all lift points for proper torque.
 2. Inspect lift points for damage or cracked welds. Repair or replace components as necessary.
- No riders on loader and keep 5 m (15 ft) away while lifting.
 - See Operation & Maintenance Manual for more information.

W-2840-0910

MACHINE SIGNS (DECALS) (CONT'D)

No-Text Safety Signs (Cont'd)

2. Flying Debris or Objects (7168039)

This safety sign is located on track loader undercarriages near the grease cylinder tensioning fittings.



**HIGH PRESSURE GREASE CAN
CAUSE SERIOUS INJURY**

- Do not loosen grease fitting.
- Do not loosen bleed fitting more than 1 - 1/2 turns.

W-2781-0109

3. Hot Pressurised Fluid (7169699)

This safety sign is located on the engine coolant tank cap.



**HOT PRESSURISED FLUID CAN CAUSE
SERIOUS BURNS**

- Never open hot.
- OPEN SLOWLY.

W-2755-EN-0909

4. Crush Hazard (6713507)

This safety sign is located on the side of each lift arm.



**Keep away from the operating machine to avoid
serious injury or death.**

W-2520-0106

PUBLICATIONS AND TRAINING RESOURCES

The following publications are also available for your Bobcat loader. You can order them from your Bobcat dealer.

For the latest information on Bobcat products and the Bobcat Company, visit our web site at training.bobcat.com or www.bobcat.com.



OPERATION & MAINTENANCE MANUAL

6904978

Complete instructions on the correct operation and the routine maintenance of the Bobcat loader.



T110 SERVICE MANUAL

6904979

Complete maintenance instructions for your Bobcat loader.



OPERATOR'S HANDBOOK

6986652

Gives basic operation instructions and safety warnings.



OPERATING INSTRUCTIONS

INSTRUMENT PANEL IDENTIFICATION	33
Cab Light	33
Left Panel	34
Display Screen	37
Standard Key Panel	38
Keyless Start Panel	38
Deluxe Instrumentation Panel	39
Side Panel	40
Front Panel	40
 CONTROL IDENTIFICATION	 41
Standard Controls	41
Selectable Joystick Controls (SJC)	42
 SEAT BAR RESTRAINT SYSTEM	 43
Operation	43
 BOBCAT INTERLOCK CONTROL SYSTEM (BICS™)	 44
Operation	44
 LIFT ARM BYPASS CONTROL	 45
Operation	45
 PARKING BRAKE	 45
Operation	45
 TRACTION LOCK OVERRIDE	 45
Operation	45
 EMERGENCY EXIT	 46
Rear Window	46
Front Door	46
 BACK-UP ALARM SYSTEM	 47
Description	47
Operation	47
 ENGINE SPEED CONTROL	 48
Operation	48
 DRIVING AND STEERING THE LOADER	 49
Available Control Configurations	49
Operation (Standard)	49
Operation (SJC) In 'ISO' Control Pattern	50
Operation (SJC) In 'H' Control Pattern	51
 STOPPING THE LOADER	 51
Using The Control Levers Or Joysticks	51



TWO-SPEED CONTROL	52
Description	52
Operation (SJC)	52
SPEED MANAGEMENT	53
Operation	53
Changing The Factory Default Setting	54
DRIVE RESPONSE	55
Description	55
Operation	55
STEERING DRIFT COMPENSATION	57
Description	57
Operation	57
HYDRAULIC CONTROLS	59
Description	59
Standard Controls	59
Selectable Joystick Controls (SJC) In 'ISO' Control Pattern	59
Selectable Joystick Controls (SJC) In 'H' Control Pattern	60
Hydraulic Bucket Positioning	60
Front Auxiliary Hydraulic Control Lockout	60
FRONT Auxiliary Hydraulics Operation (Variable Flow)	61
FRONT Auxiliary Hydraulics Operation (Continuous Flow)	62
Quick Couplers	63
Relieve Auxiliary Hydraulic Pressure (Loader And Attachment)	64
ATTACHMENT CONTROL DEVICE (ACD)	65
Description	65
DAILY INSPECTION	66
Daily Inspection And Maintenance	67
PRE-STARTING PROCEDURE	68
Entering The Loader	68
Operation & Maintenance Manual And Operator's Handbook Locations	68
Seat Adjustment	69
Seat Belt Adjustment	70
Seat Bar	70
STARTING THE ENGINE	71
Standard Key Panel	71
Keyless Start Panel	73
Deluxe Instrumentation Panel	75
Cold Temperature Starting	77
Warming The Hydraulic / Hydrostatic System	77
MONITORING THE DISPLAY PANELS	78
Left Panel	78
Warning And Shutdown	78



STOPPING THE ENGINE AND LEAVING THE LOADER	79
Procedure	79
ATTACHMENTS	80
Choosing The Correct Bucket	80
Pallet Forks	80
Installing And Removing The Attachment (Hand Lever Bob-Tach)	81
Installing And Removing The Attachment (Power Bob-Tach)	83
TRACK UNDERCARRIAGE SYSTEM	86
Introduction	86
Compact Track Loader Operating And Maintenance Tips	86
OPERATING PROCEDURE	88
Inspect The Work Area	88
Basic Operating Instructions	88
Driving On Public Roads	88
Operating With A Full Bucket	89
Operating With An Empty Bucket	89
Filling And Emptying The Bucket (Foot Pedals)	90
Leveling The Ground Using Float (Foot Pedals)	91
Digging And Filling A Hole (Foot Pedals)	91
Filling And Emptying The Bucket (SJC - 'H' Pattern)	92
Leveling The Ground Using Float (SJC - 'H' Pattern)	93
Digging And Filling A Hole (SJC - 'H' Pattern)	94
Filling And Emptying The Bucket (SJC - 'ISO' Pattern)	95
Leveling The Ground Using Float (SJC - 'ISO' Pattern)	96
Digging And Filling A Hole (SJC - 'ISO' Pattern)	96
TOWING THE LOADER	97
Procedure	97
LIFTING THE LOADER	97
Single-Point Lift	97
TRANSPORTING THE LOADER ON A TRAILER	98
Loading And Unloading	98
Fastening	98



Bobcat®

INSTRUMENT PANEL IDENTIFICATION

Figure 5



The left panel [Figure 5] is described in more detail. (See Left Panel on Page 34.)

Figure 6

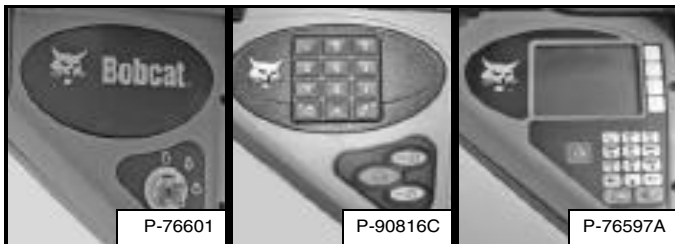

The right panel [Figure 6] is described in more detail. (See Standard Key Panel on Page 38.), (See Keyless Start Panel on Page 38.) or (See Deluxe Instrumentation Panel on Page 39.)

Figure 7

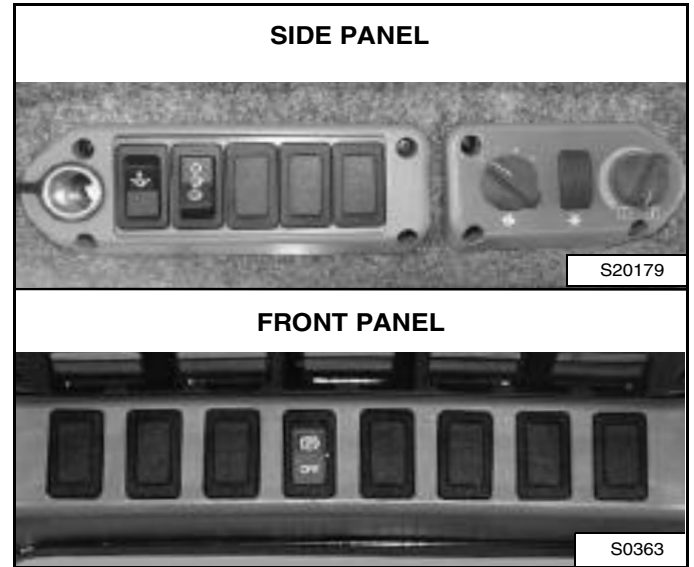

The side and front panels [Figure 7] are described in more detail. (See Side Panel on Page 40.) and (See Front Panel on Page 40.)

Cab Light

Figure 8

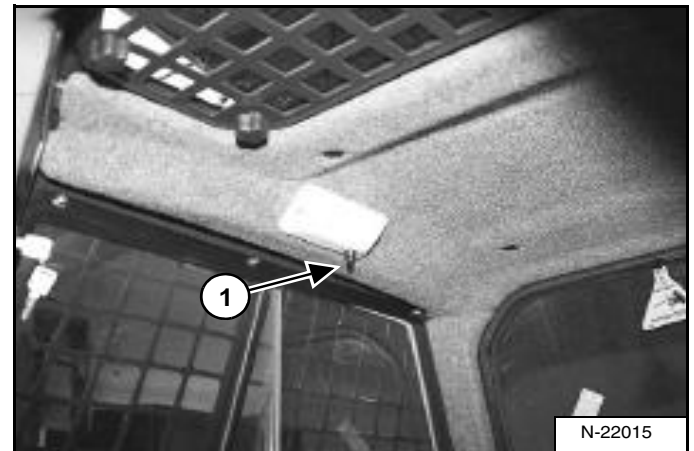

Push the button (Item 1) [Figure 8] to turn the light ON. Push the button again to turn OFF.

INSTRUMENT PANEL IDENTIFICATION (CONT'D)

Left Panel

Figure 9



P-76459C

The left instrument panel [Figure 9] is the same for Standard Key Panel, Keyless Start Panel and Deluxe Instrumentation Panel equipped machines.

The table on the facing page shows the DESCRIPTION and FUNCTION / OPERATION for each of the components of the left panel.



INSTRUMENT PANEL IDENTIFICATION (CONT'D)

Left Panel (Cont'd)

REF. NO.	DESCRIPTION	FUNCTION / OPERATION
1	ENGINE TEMPERATURE GAUGE	Shows the engine coolant temperature.
2	LEFT TURN SIGNAL (Option)	Indicates left turn signals are ON.
3	GENERAL WARNING	Malfunction with one or more machine functions. (See Service Codes*)
4	TWO-SPEED (Option)	High range selected. (Available with SJC controls only.)
5	ENGINE MALFUNCTION	Engine malfunction or failure. (See Service Codes*)
6	ENGINE COOLANT TEMPERATURE	Engine coolant temperature high or sensor error.
7	DISPLAY SCREEN	Displays information. (See Display Screen in this manual.)
8	SEAT BELT	Instructs operator to fasten seat belt. Remains lit for 45 seconds.
9	SEAT BAR	The light comes on when the seat bar is UP.
10	LIFT & TILT VALVE	The light comes on when the lift and tilt functions cannot be operated.
11	PARKING BRAKE	The light comes on when the loader cannot be driven.
12	RIGHT TURN SIGNAL (Option)	Indicates right turn signals are ON.
13	SHOULDER BELT	Not used.
14	HYDRAULIC SYSTEM MALFUNCTION	Hydraulic system malfunction or failure. (See Service Codes*)
15	FUEL	Fuel level low or sensor error.
16	FUEL GAUGE	Shows the amount of fuel in the tank.
17	<p>LIGHTS - Without Road Option</p> <p>- With Road Option</p> <p>- All Loaders</p>	<p>Press once for REAR taillights. (Right green LED will light.) Press a second time to turn FRONT and REAR work lights ON. REAR taillights will turn OFF. (Left green LED will light.) Press a third time to turn all lights off. (Left and right green LEDs will be off.)</p> <p>Press once for FRONT boom light, license plate light and REAR taillights. (Right green LED will light.) Press a second time to turn FRONT and REAR work lights ON. FRONT boom light, license plate light and REAR taillights will turn OFF. (Left green LED will light.) Press a third time to turn all lights off. (Left and right green LEDs will be off.)</p> <p>Press and hold five seconds to show software version in display screen.</p>
18	HIGH-FLOW	Not used.
19	AUXILIARY HYDRAULICS	Press once to engage the auxiliary hydraulics. (Left green LED will light.) Press a second time to disengage.

* See SYSTEM SETUP & ANALYSIS for Service Code description. (See DIAGNOSTIC SERVICE CODES on Page 151.)



INSTRUMENT PANEL IDENTIFICATION (CONT'D)

Left Panel (Cont'd)

REF. NO.	DESCRIPTION	FUNCTION / OPERATION
20	INFORMATION	Cycles through (after each button press): <ul style="list-style-type: none"> • Hourmeter (On start up) • Engine rpm • Battery voltage • Maintenance clock • Service codes*
21	TRACTION LOCK OVERRIDE	Functions only when the seat bar is raised and the engine is running. Press once to unlock the brakes. Allows you to use the steering levers or joystick(s) to move the loader forward or backward when using the backhoe attachment. (See TRACTION LOCK OVERRIDE in this manual.) Press a second time to lock the brakes.
22	PRESS TO OPERATE LOADER	Press to activate the BICS™ when the seat bar is down and operator is seated in operating position. Button will light. Press and hold three seconds to engage Drive Response and Steering Drift Compensation. (See DRIVE RESPONSE and STEERING DRIFT COMPENSATION in this manual.)
23	ALARM	The alarm beeps when Error, Warning or Shutdown conditions exist.

* See SYSTEM SETUP & ANALYSIS for Service Code description. (See DIAGNOSTIC SERVICE CODES on Page 151.)



INSTRUMENT PANEL IDENTIFICATION (CONT'D)

Display Screen

The display screen can display the following information:

- Operating hours.
- Engine revolutions per minute (rpm).
- Speed management setting.
- Maintenance clock countdown.
- Battery voltage.
- Service codes.
- Engine preheat countdown.
- Steering drift compensation setting.
- Drive response setting.

Figure 10

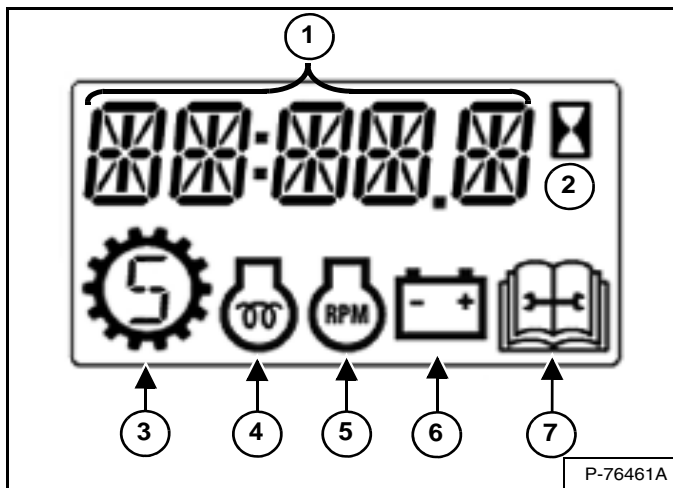

The display screen is shown in **[Figure 10]**. The data display will show operating hours upon startup.

1. **Data Display.**
2. **Hourmeter.**
3. **Speed Management.**
4. **Engine Preheat.**
5. **Engine Revolutions Per Minute.**
6. **Battery / Charging Voltage.**
7. **Service.**

INSTRUMENT PANEL IDENTIFICATION (CONT'D)

Standard Key Panel

Figure 11



This machine may be equipped with a Standard Key Panel [Figure 11].

The Standard Key Panel is used to turn the loader electrical system on and off, and to start and stop the engine.

Keyless Start Panel

Figure 12

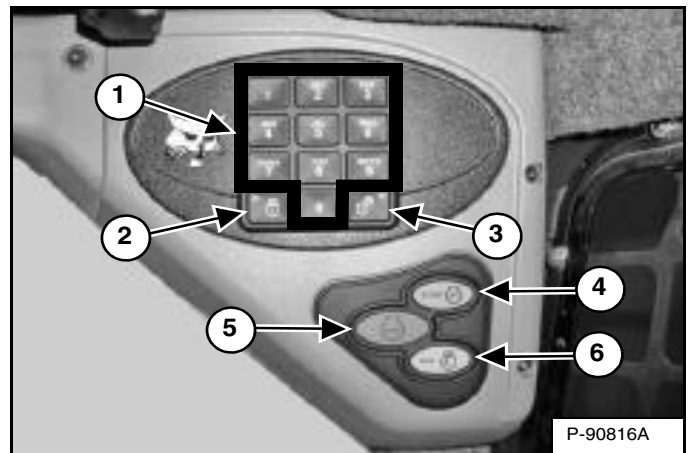

This machine may be equipped with a Keyless Start Panel [Figure 12].

1. **Keypad (keys 1 through 0):** Used to enter a number code (password) to allow starting the engine. An asterisk will show in the left panel display screen for each key press.
2. **LOCK Key:** Used to lock keypad. The lock key will display a red light to indicate a password is required to start the loader. (See Password Lockout Feature on Page 159.)
3. **UNLOCK Key:** Used to unlock keypad. The unlock key will display a green light to indicate the loader can be started without a password. (See Password Lockout Feature on Page 159.)
4. **START Button:** Used to start the engine.
5. **STOP Button:** Used to stop the engine and shut down the loader's electrical system.
6. **RUN Button:** Used to turn on the loader's electrical system.



INSTRUMENT PANEL IDENTIFICATION (CONT'D)

Deluxe Instrumentation Panel

Figure 13

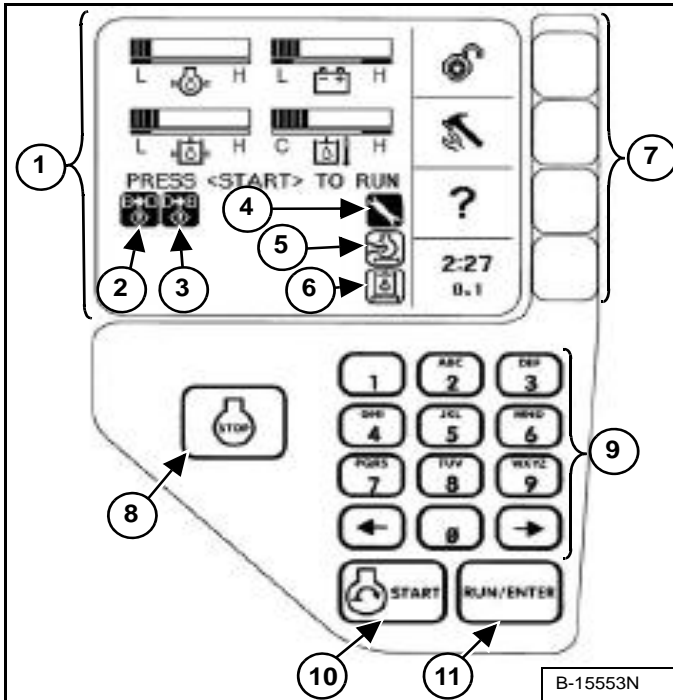

This machine may be equipped with a Deluxe Instrumentation Panel [Figure 13].

1. **Display Screen:** The Display Screen is where all system setup, monitoring, troubleshooting and error conditions are displayed.
2. **Bobcat Main Controller Error:** Indicates communication error between Bobcat Main Controller and Deluxe Instrumentation Panel. (See DIAGNOSTIC SERVICE CODES on Page 151.)
3. **Display Error:** Indicates communication error between instrument panel and Bobcat controller. (See DIAGNOSTIC SERVICE CODES on Page 151.)
4. **BobCARE PMSM Icon:** Indicates planned maintenance is due. (See MAINTENANCE CLOCK on Page 162.)
5. **Engine Air Filter Icon:** Indicates engine air filter requires service.
6. **Hydraulic Filter Icon:** Indicates hydraulic filter requires service.
7. **Selection Buttons:** The four Selection Buttons allow you to select items from the Display Screen and scroll through screens.
8. **Stop Button:** Used to stop the engine and shut down the loader electrical system.

9. **Keypad:** The numeric keypad has two functions:
 - To enter a number code (password) to allow starting the engine.
 - To enter a number as directed for further use of the Display Screen.
10. **Start Button:** Used to start the engine.
11. **Run / Enter Button:** Used to turn on the loader electrical system.

Figure 14

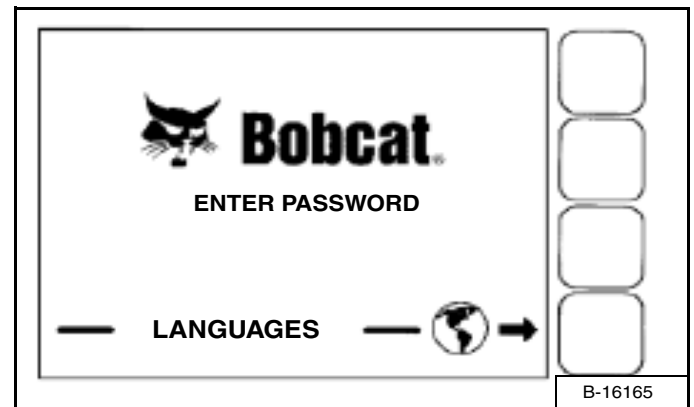

The first screen you will see on your new loader will be as shown in [Figure 14].

When this screen is on the display you can enter the password and start the engine or change the Display Screen setup features.

NOTE: Your new loader (with Deluxe Instrumentation Panel) will have an Owner Password. Your dealer will provide you with this password. Change the password to one that you will easily remember to prevent unauthorised use of your loader. (See Changing The Owner Password on Page 159.) Keep your password in a safe place for future needs.

Change Language: Press the Selection Button at the end of the arrow [Figure 14] to go to the next screen. Use the Keypad to select the number of the language.

Press EXIT. The screen will return to [Figure 14]. You can then enter the password and start the engine.

See CONTROL PANEL SETUP for further description of screens to setup the system for your use. (See CONTROL PANEL SETUP on Page 157.)

NOTE: Pressing the EXIT key will go to the previous screen and you can continue pressing until you get to the initial (home) screen. SHORTCUT: Press the "0" (zero) key to get to the home screen immediately.



INSTRUMENT PANEL IDENTIFICATION (CONT'D)

Side Panel

Figure 15

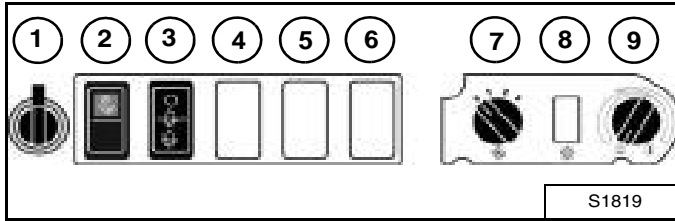

REF. NO.	DESCRIPTION	FUNCTION / OPERATION
1	POWER PORT	Provides a 12 volt receptacle for accessories.
2	TRAVEL LOCK	Press the top of the switch to lock the lift and tilt hydraulic functions for travel. Press the bottom of the switch to turn travel lock OFF.
3	FRONT WIPER	Press the bottom of the switch to start the front wiper (press and hold for washer fluid). Press the top of the switch to stop the wiper.
4	REAR WIPER (Option)	Press the bottom of the switch to start the rear wiper (press and hold for washer fluid). Press the top of the switch to stop the wiper.
5	NOT USED	- - -
6	NOT USED	- - -
7	FAN MOTOR (Option)	Turn clockwise to increase fan speed; anticlockwise to decrease. There are four positions; OFF-1-2-3.
8	NOT USED	- - -
9	TEMPERATURE CONTROL (Option)	Turn clockwise to increase the temperature; anticlockwise to decrease.

Front Panel

Figure 16

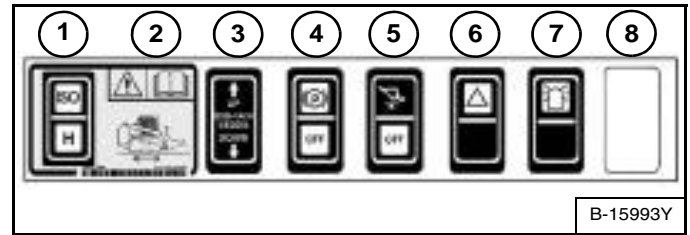

NOTE: Parking Brake (Item 4) [Figure 16] is standard on all loaders.

REF. NO.	DESCRIPTION	FUNCTION / OPERATION
1	SELECTABLE JOYSTICK CONTROLS (SJC) (Option)	Press the top to select 'ISO' Control Pattern; bottom to select 'H' Control Pattern.
2	POWER BOB-TACH (Option)	Press and hold the up arrow to disengage the Bob-Tach wedges. Press and hold the down arrow to engage the wedges into the mounting frame holes.
3	NOT USED	- - -
4	PARKING BRAKE (Standard on all loaders)	Press the top to engage the PARKING BRAKE; bottom to disengage.
5	HYDRAULIC BUCKET POSITIONING	Press the top to engage Hydraulic Bucket Positioning; bottom to disengage.
6	HAZARD LIGHTS (Option)	Press the top to turn the HAZARD LIGHTS ON; bottom to turn OFF.
7	ROTATING BEACON (Option) <i>or</i> STROBE LIGHT (Option)	Press the top to turn the LIGHT ON; bottom to turn OFF.
8	NOT USED	- - -

CONTROL IDENTIFICATION

This loader has two control configurations available to operate lift / tilt functions and driving / steering the loader:

- Standard Controls - Uses foot pedals for lift and tilt functions.
Uses steering levers for driving and steering the loader.
- Selectable Joystick Controls (SJC) (Option) - Uses joysticks for lift / tilt functions and driving / steering the loader.

Standard Controls

Figure 17

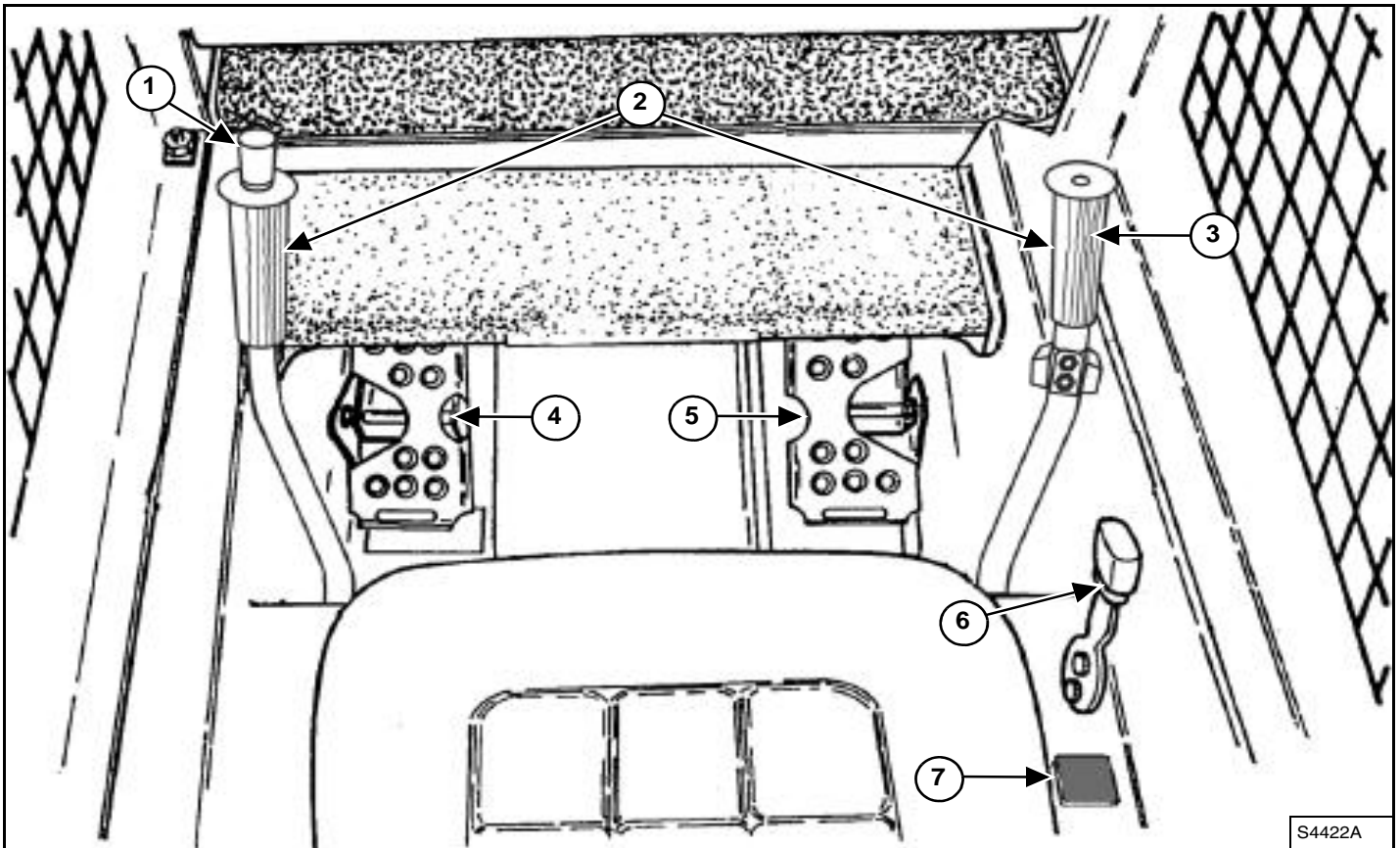

S4422A

REF. NO.	DESCRIPTION	FUNCTION / OPERATION
1	FRONT HORN	Press the button to sound the front horn.
2	STEERING LEVERS	See DRIVING AND STEERING THE LOADER in this manual.
3	AUXILIARY HYDRAULICS CONTROL	See HYDRAULIC CONTROLS in this manual.
4	LIFT ARM PEDAL	See HYDRAULIC CONTROLS in this manual.
5	TILT PEDAL	See HYDRAULIC CONTROLS in this manual.
6	ENGINE SPEED CONTROL	See ENGINE SPEED CONTROL in this manual.
7	LIFT ARM BYPASS CONTROL	See LIFT ARM BYPASS CONTROL in this manual.



CONTROL IDENTIFICATION (CONT'D)

Selectable Joystick Controls (SJC)

Figure 18

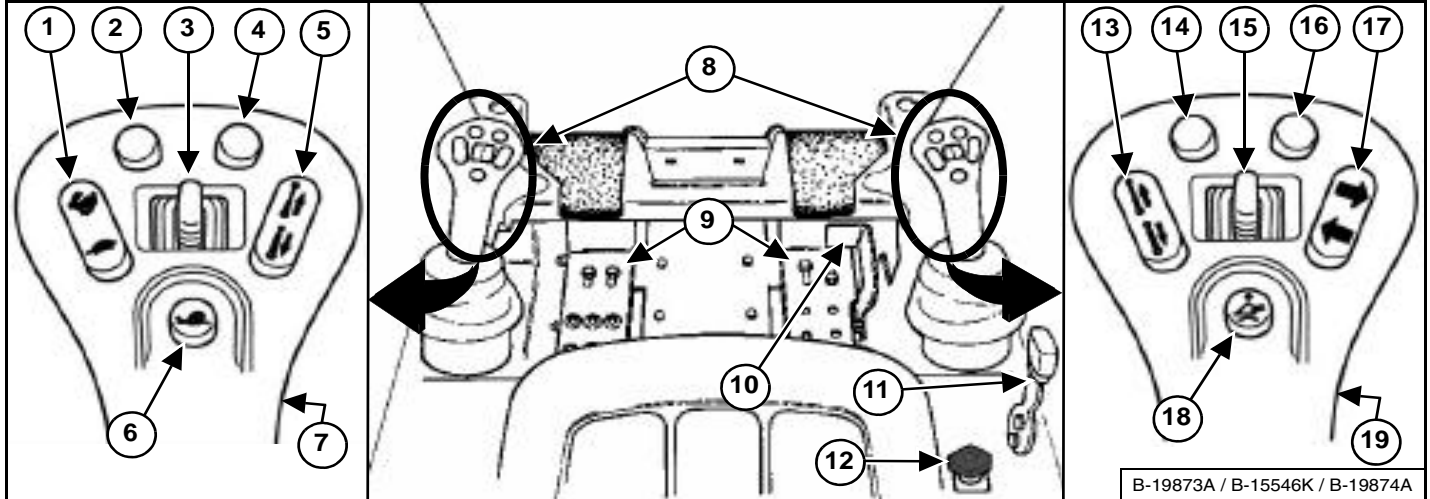

REF. NO.	DESCRIPTION	FUNCTION / OPERATION
1	TWO-SPEED CONTROL SPEED MANAGEMENT	See TWO-SPEED CONTROL in this manual. See SPEED MANAGEMENT in this manual.
* 2	STEERING DRIFT COMPENSATION Also: DRIVE RESPONSE	See STEERING DRIFT COMPENSATION in this manual. See DRIVE RESPONSE in this manual.
3	ATTACHMENT FUNCTION CONTROL	See ATTACHMENT CONTROL DEVICE in this manual.
* 4	STEERING DRIFT COMPENSATION Also: DRIVE RESPONSE	See STEERING DRIFT COMPENSATION in this manual. See DRIVE RESPONSE in this manual.
5	ATTACHMENT FUNCTION CONTROL	See ATTACHMENT CONTROL DEVICE in this manual.
6	SPEED MANAGEMENT	See SPEED MANAGEMENT in this manual.
7	FRONT HORN	Press the front switch to sound the front horn.
8	JOYSTICKS	See DRIVING AND STEERING THE LOADER and HYDRAULIC CONTROLS in this manual.
9	FOOTRESTS	Keep your feet on the footrests at all times.
10	ENGINE SPEED CONTROL (FOOT)	See ENGINE SPEED CONTROL in this manual.
11	ENGINE SPEED CONTROL (HAND)	See ENGINE SPEED CONTROL in this manual.
12	LIFT ARM BYPASS CONTROL	See LIFT ARM BYPASS CONTROL in this manual.
13	ATTACHMENT FUNCTION CONTROL	See ATTACHMENT CONTROL DEVICE in this manual.
* 14	NOT USED	---
15	FRONT AUXILIARY HYDRAULICS	See FRONT Auxiliary Hydraulics Operation in this manual.
* 16	NOT USED	---
17	TURN SIGNALS (Option)	Press the top to activate right signal; press again to turn off. Press the bottom to activate left signal; press again to turn off.
18	FLOAT CONTROL	See HYDRAULIC CONTROLS in this manual.
19	CONTINUOUS FLOW CONTROL FOR AUXILIARY HYDRAULICS	See FRONT Auxiliary Hydraulics Operation (CONTINUOUS FLOW) in this manual.

* Also used as Attachment Function Control: See your attachment Operation & Maintenance Manual.

SEAT BAR RESTRAINT SYSTEM

Operation

Figure 19



The seat bar restraint system has a pivoting seat bar with armrests (Item 1) [Figure 19].

The operator controls the use of the seat bar. The seat bar in the down position helps to keep the operator in the seat.

WARNING

AVOID INJURY OR DEATH

When operating the machine:

- Keep the seat belt fastened snugly.
- The seat bar must be lowered.
- Keep your feet on the pedal controls or footrests and hands on the controls.

W-2261-0909

When the seat bar is down, the engine is running, the PRESS TO OPERATE LOADER button is activated, and the brake is released, the lift, tilt, and traction drive functions can be operated.

When the seat bar is up, the lift, tilt and traction drive functions are deactivated and both foot pedals will be locked when returned to neutral position.

WARNING

AVOID INJURY OR DEATH

Before you leave the operator's seat:

- Lower the lift arms and put the attachment flat on the ground.
- Stop the engine.
- Engage the parking brake.
- Raise the seat bar.
- Move all controls to the NEUTRAL / LOCKED position to make sure the lift, tilt and traction drive functions are deactivated.

The seat bar system must deactivate these functions when the seat bar is up. See your Bobcat dealer for service if controls do not deactivate.

W-2463-1110

BOBCAT INTERLOCK CONTROL SYSTEM (BICS™)

Operation



AVOID INJURY OR DEATH

The Bobcat Interlock Control System (BICS™) must deactivate the lift, tilt and traction drive functions. If it does not, contact your dealer for service. **DO NOT** modify the system.

W-2151-1111

Figure 20

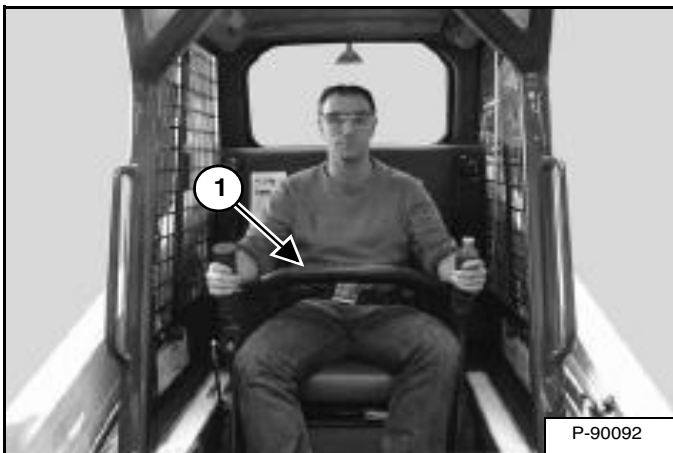

The Bobcat Interlock Control System (BICS™) has a pivoting seat bar with armrests (Item 1) [Figure 20]. The operator controls the use of the seat bar.

The BICS™ requires the operator to be seated in the operating position with the seat bar fully lowered before the lift, tilt, auxiliary hydraulics, and traction functions can be operated. The seat belt must be fastened anytime you operate the machine.



AVOID INJURY OR DEATH

When operating the machine:

- Keep the seat belt fastened snugly.
- The seat bar must be lowered.
- Keep your feet on the pedal controls or footrests and hands on the controls.

W-2261-0909

Figure 21



There are three display lights (Items 1, 2 and 3) [Figure 21] located on the left instrument panel that must be OFF to fully operate the machine.

When the seat bar is lowered, the engine is running, the PRESS TO OPERATE LOADER button is activated, and the parking brake is released, the lift, tilt, auxiliary hydraulics, and traction drive functions can be operated.

When, the seat bar is raised, the lift, tilt, auxiliary hydraulics, and traction drive functions are deactivated.



AVOID INJURY OR DEATH

Before you leave the operator's seat:

- Lower the lift arms and put the attachment flat on the ground.
- Stop the engine.
- Engage the parking brake.
- Raise the seat bar.
- Move all controls to the NEUTRAL / LOCKED position to make sure the lift, tilt and traction drive functions are deactivated.

The seat bar system must deactivate these functions when the seat bar is up. See your Bobcat dealer for service if controls do not deactivate.

W-2463-1110

LIFT ARM BYPASS CONTROL

Operation

Figure 22

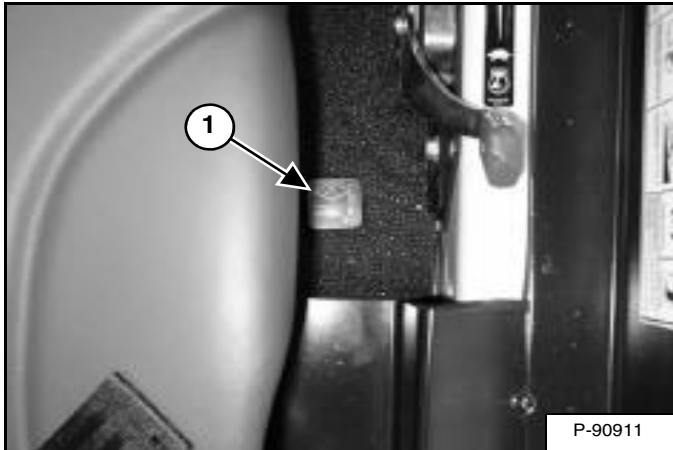

The lift arm bypass control (Item 1) [Figure 22] is used to lower the lift arms if the lift arms cannot be lowered during normal operations.

1. Sit in the operator's seat.
2. Fasten the seat belt and lower the seat bar.
3. Turn the knob (Item 1) [Figure 22] clockwise 1/4 turn.
4. Pull up and hold the knob until the lift arms lower.

PARKING BRAKE

Operation

Figure 23

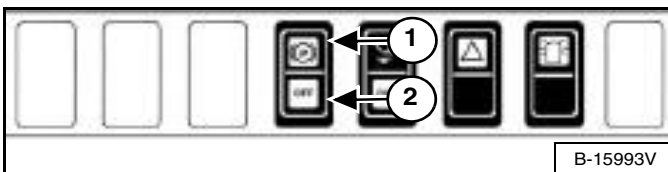

Press the top of the switch (Item 1) [Figure 23] to engage the parking brake. The red light in the switch will turn on. The traction drive system will be locked.

Press the bottom of the switch (Item 2) [Figure 23] to disengage the parking brake. The red light in the switch will turn off. The traction drive system will be unlocked.

NOTE: The PARKING BRAKE light on the left instrument panel will remain ON until the engine is started, the PRESS TO OPERATE LOADER button is pressed and the parking brake is disengaged.

TRACTION LOCK OVERRIDE

Operation

Figure 24

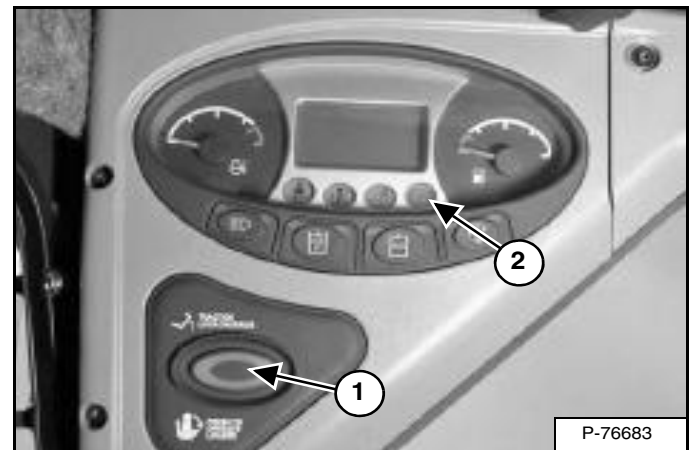

(Functions Only When The Seat Bar Is Raised And The Engine Is Running) There is a TRACTION LOCK OVERRIDE button (Item 1) [Figure 24] on the left instrument panel which will allow you to use the steering levers to move the loader forward and backward when using the backhoe attachment.

- Press the TRACTION LOCK OVERRIDE button once to unlock traction drive. The PARKING BRAKE light (Item 2) [Figure 24] will be OFF.
- Press the button a second time to lock the traction drive. The PARKING BRAKE light (Item 2) [Figure 24] will be ON.

NOTE: The TRACTION LOCK OVERRIDE button will unlock the traction drive when the seat bar is raised and the engine is running.

NOTE: The TRACTION LOCK OVERRIDE button will function if the parking brake is in the engaged or disengaged position and the engine is running. If the parking brake switch is turned ON, the red light in the parking brake switch will turn OFF when TRACTION LOCK OVERRIDE is engaged.

EMERGENCY EXIT

The front opening on the operator cab and rear window provide exits.

Rear Window

Figure 25



Pull on the tag on the top of the rear window to remove the rubber cord [Figure 25].

Push the rear window out of the rear of the operator cab.

Figure 26



Exit through the rear of the operator cab [Figure 26].

Front Door

NOTE: If the loader has a Special Application Door Kit installed, the window of the front door is NOT an emergency exit.

Figure 27



Pull the plastic loop at the top of the window in the front door to remove the rubber cord [Figure 27].

Figure 28

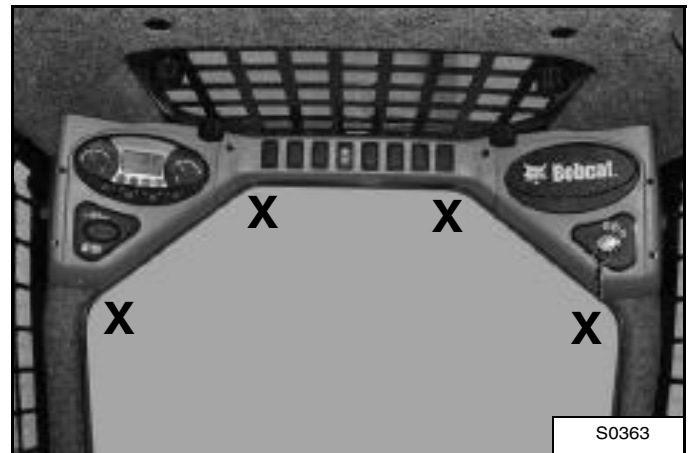

Push the window out with your foot at any corner of the window [Figure 28].

Exit through the front door.

BACK-UP ALARM SYSTEM

This machine may be equipped with a Back-up Alarm.

Description

Figure 29

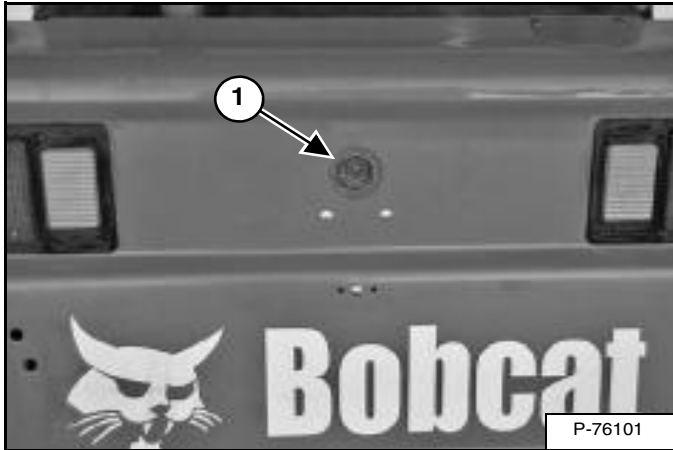

The back-up alarm (Item 1) [Figure 29] is located on the inside of the rear door.

A back-up alarm is not a substitute for looking to the rear when operating the loader in reverse, or for keeping bystanders away from the work area. Operators **must always** look in the direction of travel, including **reverse**, and must also keep bystanders away from the work area, even though the loader is equipped with a back-up alarm.

Operators must be trained to **always** look in the direction of travel, **including when operating the loader in reverse** and to keep bystanders away from the work area. Other workers should be trained to **always** keep away from the operator's work area and travel path.

Operation

! WARNING

AVOID INJURY OR DEATH

- Always keep bystanders away from the work area and travel path.
- The operator must always look in the direction of travel.
- The back-up alarm must sound when operating the machine in the reverse direction.

W-2783-0409

The back-up alarm will sound when the operator moves both steering levers or joystick(s) into the reverse position. Slight movement of the steering levers into the reverse position is required with hydrostatic transmissions, before the back-up alarm will sound.

If alarm does not sound or for adjustment instructions, see inspection and maintenance instructions for the back-up alarm system in the preventive maintenance section of this manual. (See BACK-UP ALARM SYSTEM on Page 113.)

ENGINE SPEED CONTROL

Operation

Figure 30

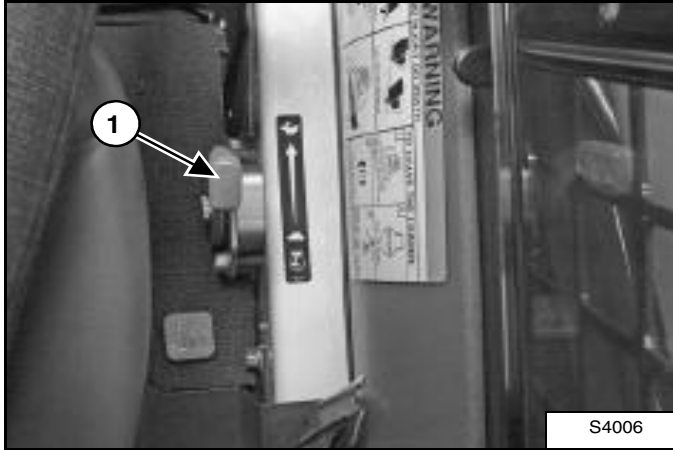

The engine speed control lever is at the right side of the operator's seat (Item 1) [Figure 30].

Move the lever forward to increase engine speed. Move backward to decrease engine speed.

Figure 31

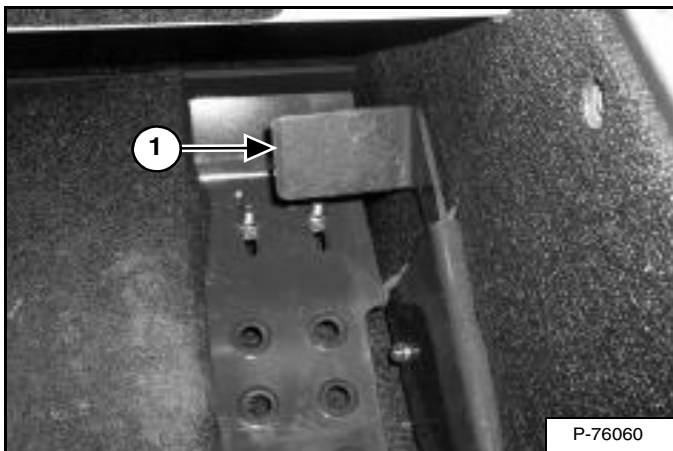

There is a foot operated engine speed control pedal (Item 1) [Figure 31] in addition to the engine speed control lever on SJC equipped machines. It is located on the right side floor above the footrest.

DRIVING AND STEERING THE LOADER

Available Control Configurations

The loader has two configurations available:

- *Standard Controls* - Two Steering Levers control drive and steering functions.
- *Selectable Joystick Controls (SJC) (Option)* -
(*'ISO' Pattern*) Left joystick controls the drive and steering functions.
(*'H' Pattern*) Left and right joysticks control left and right side drive and steering functions.

Operation (Standard)

Figure 32

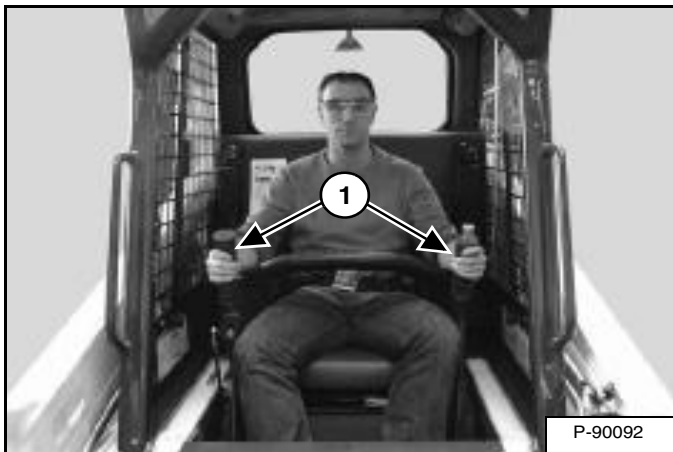

The steering levers (Item 1) [Figure 32] are on the left and right side in front of the seat.

Move the levers smoothly. Avoid sudden starting and stopping.

WARNING

AVOID INJURY OR DEATH

When operating the machine:

- **Keep the seat belt fastened snugly.**
- **The seat bar must be lowered.**
- **Keep your feet on the pedal controls and hands on steering levers.**

W-2046-0108

Figure 33

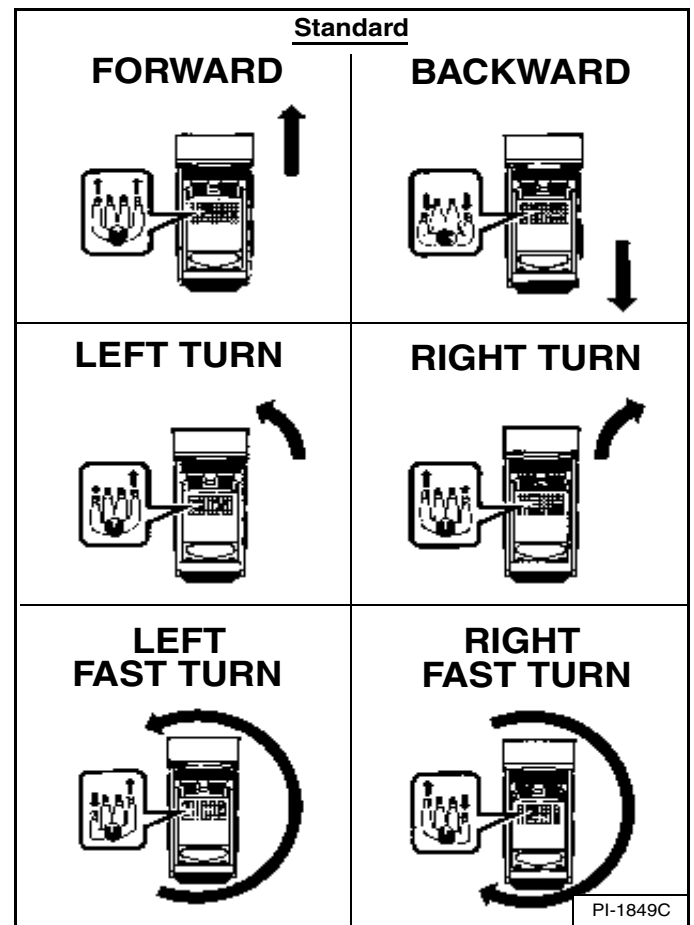

The steering levers control forward and backward travel and turning the loader [Figure 33].

Forward Travel - Push both levers forward.

Backward Travel - Pull both levers backward.

Normal Turning - Move one lever farther forward than the other.

Fast Turning - Push one lever forward and pull the other lever backward.

DRIVING AND STEERING THE LOADER (CONT'D)

Operation (SJC) In 'ISO' Control Pattern

Figure 34

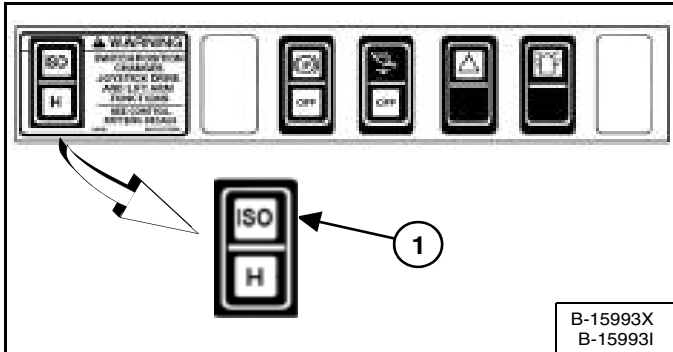

Select the 'ISO' control pattern by pressing the top of the switch (Item 1) [Figure 34].



AVOID INJURY OR DEATH

When operating the machine:

- Keep the seat belt fastened snugly.
- The seat bar must be lowered.
- Keep your feet on the foot rests and hands on control levers.

W-2399-0501

Figure 35



The joystick that controls drive and steering is on the left side in front of the seat (Item 1) [Figure 35].

Move the joystick smoothly. Avoid sudden starting and stopping.

Figure 36

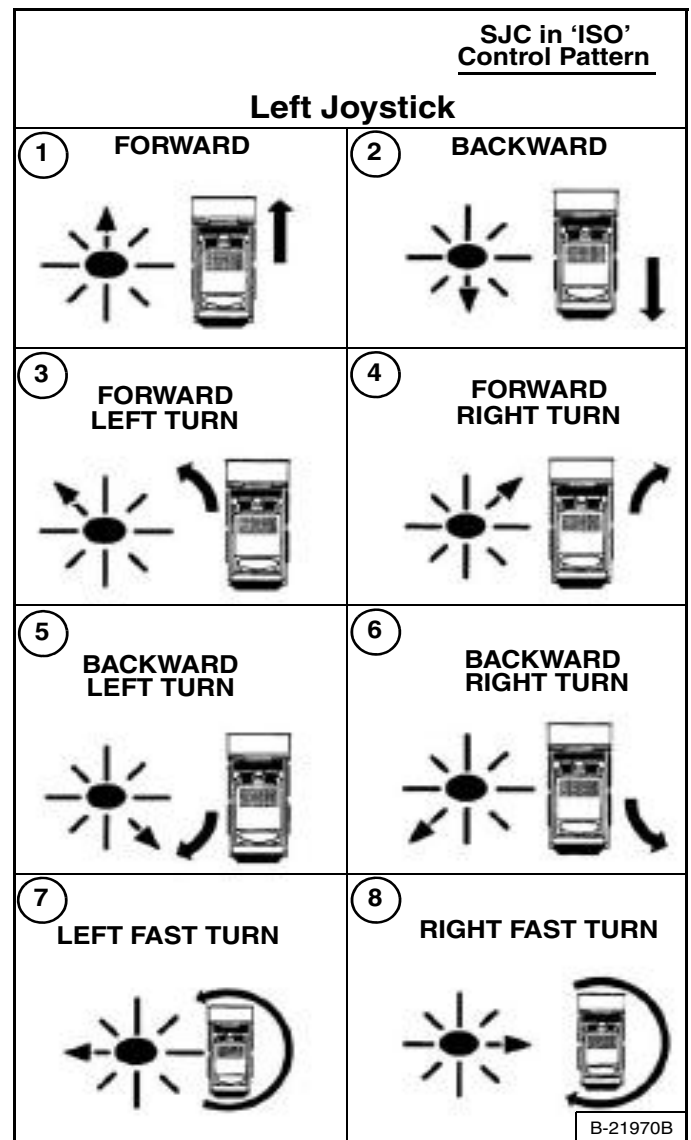

Left Joystick Functions (Drive And Steering) [Figure 36].

1. **Forward Travel** - Move joystick forward.
2. **Backward Travel** - Move joystick backward.
3. **Forward Left Turn** - Move joystick forward and to the left.
4. **Forward Right Turn** - Move joystick forward and to the right.
5. **Backward Left Turn** - Move joystick backward and to the right.
6. **Backward Right Turn** - Move joystick backward and to the left.
7. **Left Fast Turn** - Move joystick to the left.
8. **Right Fast Turn** - Move joystick to the right.

DRIVING AND STEERING THE LOADER (CONT'D)

Operation (SJC) In 'H' Control Pattern

Figure 37

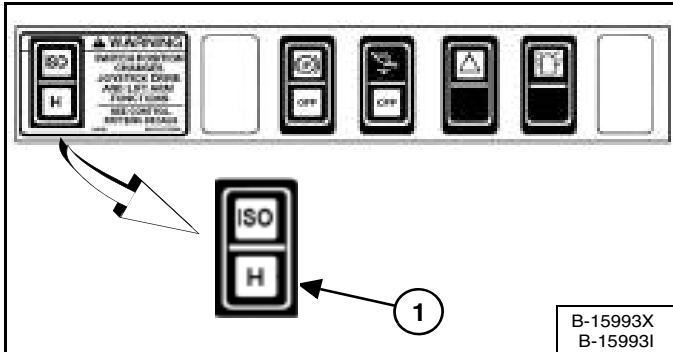

Select the 'H' control pattern by pressing the bottom of the switch (Item 1) [Figure 37].



WARNING

AVOID INJURY OR DEATH

When operating the machine:

- Keep the seat belt fastened snugly.
- The seat bar must be lowered.
- Keep your feet on the foot rests and hands on control levers.

W-2399-0501

Figure 38



Both joysticks control drive and steering and are located on the left and right side in front of the seat (Item 1) [Figure 38].

Move the joysticks smoothly. Avoid sudden starting and stopping.

Figure 39

Left Joystick	Right Joystick	SJC in 'H' Control Pattern	
1 N ↑	N ↑	↑	FORWARD
2 N ↓	N ↓	↓	BACKWARD
3 N ↑	N ↑ ↙	↙	LEFT TURN
4 N ↑	N ↑ ↘	↘	RIGHT TURN
5 N ↓	N ↑	↻	LEFT FAST TURN
6 N ↑	N ↓	↻	RIGHT FAST TURN

Joystick Functions (Drive And Steering) [Figure 39]

1. **Forward Travel** - Move both joysticks forward.
2. **Backward Travel** - Move both joysticks backward.
3. **Forward Left Turn** - Move the right joystick farther forward than the left joystick.
4. **Forward Right Turn** - Move the left joystick farther forward than the right joystick.
5. **Left Fast Turn** - Move the left joystick backward and the right joystick forward.
6. **Right Fast Turn** - Move the left joystick forward and the right joystick backward.

STOPPING THE LOADER

Using The Control Levers Or Joysticks

When the steering levers or joysticks are moved to the neutral position, the hydrostatic transmission will act as a *service brake* to stop the loader.

TWO-SPEED CONTROL

Description

Two-speed is only available with SJC controls. Two-speed allows you to reduce cycle times when there is a long travel distance between the dig site and the dump site. You can also use the two-speed when traveling from one job site to another at faster speeds.



HITTING OBSTRUCTIONS AT HIGH RANGE SPEEDS CAN CAUSE SERIOUS INJURY OR DEATH
Fasten shoulder belt for additional restraint when operating at high range speeds.

W-2754-0908

Figure 40

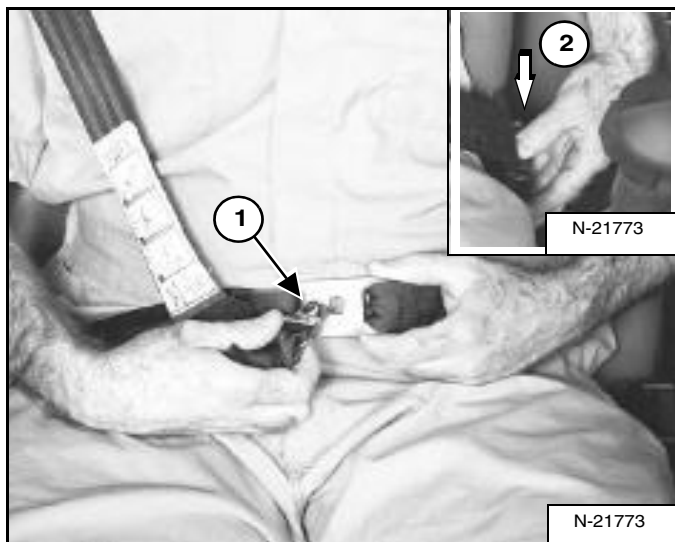

NOTE: The 3-point restraint must be used when selecting two-speed operation [Figure 40].

Connect the shoulder belt to the lap belt (Item 1). Pull the lap belt across to the left side of the seat (Item 2) [Figure 40] and fasten.

The shoulder belt must be positioned over your right shoulder and lap belt over your lower hips [Figure 40].

Operation (SJC)

Figure 41

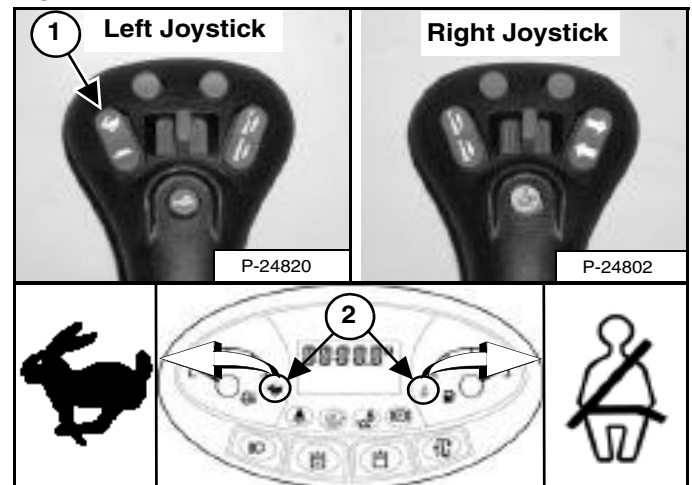

NOTE: You must disengage Speed Management before you can select high range.

Press the top of the switch (Item 1) on the left joystick for high range. The two-speed and shoulder belt icons located on the left instrument panel (Item 2) [Figure 41] will come on.

Press the bottom of the switch for low range.

SPEED MANAGEMENT

Speed Management is available on SJC equipped machines.

Operation

Speed Management allows the loader to be maneuvered at a slower travel speed, even during maximum movement of the joystick(s).

This feature can be useful when installing attachments, loading or unloading, and certain applications. (EXAMPLES: Landscaping, tilling, trenching)

Figure 42



Press the button (Item 1) [Figure 42] on the left joystick once to engage Speed Management.

Figure 43

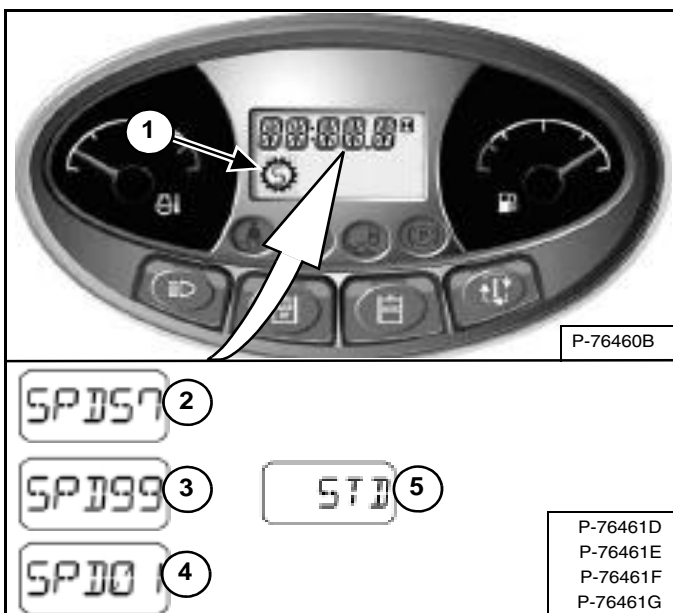

The Speed Management icon (Item 1) [Figure 43] will appear in the display and remain on until the Speed Management button is pressed again or the machine is turned off.

When Speed Management is engaged, the machine will travel at the factory default setting of 57% of Standard Travel Speed and the percentage [SPD 57] will appear in the display (Item 2) [Figure 43].

NOTE: The factory default setting can be changed by the operator. (See Changing The Factory Default Setting on Page 54.)

While Speed Management is engaged, press the top of the Speed Control switch (Item 2) [Figure 42] to increase the speed up to 99% [SPD 99] or the bottom of the switch (Item 3) [Figure 42] to decrease the speed down to 1% [SPD 01]. The percentages will appear in the display (Items 2, 3 and 4) [Figure 43].

Press button (Item 1) [Figure 42] again to disengage Speed Management and return to Standard Travel Speed. [STD] (Item 5) [Figure 43] will appear in the display.

The system will retain the speed percentage as long as the key remains ON or the STOP button has not been pressed.

EXAMPLE: You can be using the machine at 40% and then disengage Speed Management to reposition the loader, then re-engage Speed Management. The speed percentage will still be at 40%.

EXAMPLE: Turning the key OFF or pressing the STOP button will return the Speed Management setting to default. The next time you start the engine and engage Speed Management, the speed will be at 57% (factory default setting) or the last default setting saved by the operator. (See Changing The Factory Default Setting on Page 54.)

SPEED MANAGEMENT (CONT'D)

Changing The Factory Default Setting

The Speed Management factory default setting can be changed by the operator to save adjustment time.

EXAMPLE: Your machine is often used for trenching and you prefer a Speed Management setting of 28% of Standard Travel Speed for that application. The Speed Management default setting can be changed to 28% of Standard Travel Speed instead of the factory default setting of 57%. Each time you start the machine and first select Speed Management, the machine will default to 28% of Standard Travel Speed.

Engage Speed management. (See Operation on Page 53.)

Figure 44

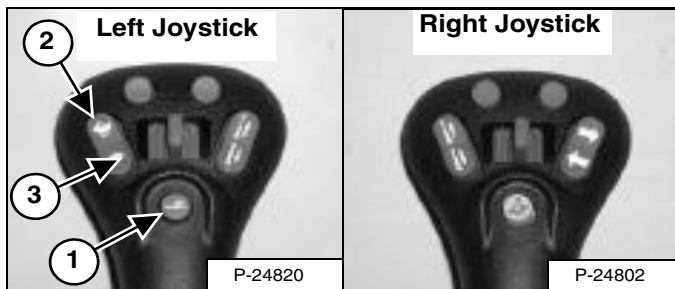

Adjust the speed percentage higher (Item 2) or lower (Item 3) [Figure 44] by pressing the Speed Control switch until the desired default setting is displayed.

Press and hold the button (Item 1) [Figure 44] on the left joystick to save the default setting.

Figure 45

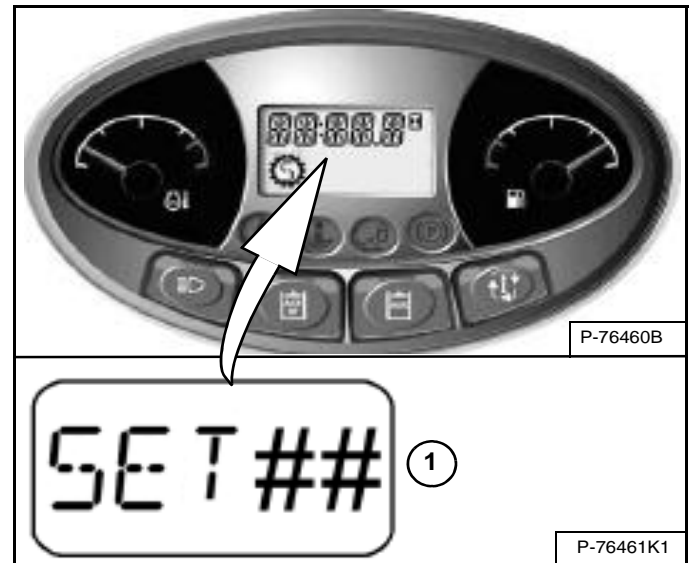

The alarm will beep once, display [SET ##] (## will be the percentage you selected) (Item 1) [Figure 45] and remain in Speed Management mode.

Pressing the button (Item 1) [Figure 44] on the left joystick or turning the machine off will disengage Speed Management and return the loader to Standard Travel Speed.

When Speed Management is first selected each time the machine is started, the percentage you selected will be the default setting. Speed Management can still be adjusted from 1% to 99% of Standard Travel Speed.

The default setting can be changed any time the operator chooses.



DRIVE RESPONSE

Drive Response is available on SJC equipped machines.

NOTE: An upgrade to the loader software may be required if this feature does not function as described in this manual. See your Bobcat dealer to update your machine software version if necessary.

Description

Drive Response changes how responsive (more or less) the loader drive and steering systems are when the operator moves the joystick(s).

Drive Response can be changed by the operator for different drive response preferences and various job conditions and attachment use.

NOTE: Changes to drive response do not affect braking or stopping the loader.

There are three drive response settings:

- **[DR-1]** provides a smooth responsive reaction to joystick movement. (Drive only)
- **[DR-2]** is the default setting and provides a normal responsive reaction to joystick movement. (Drive only)
- **[DR-3]** provides a quick responsive reaction to joystick movement. (Drive only)

Operation

NOTE: Changes CANNOT be performed until the seat bar is lowered, the engine is started and the PRESS TO OPERATE LOADER button is pressed to activate the BICS™.

Perform pre-starting and starting procedures:

1. Fasten seat belt.
2. Lower seat bar.
3. Place joysticks in neutral position.
4. Start the engine.
5. Press the PRESS TO OPERATE LOADER button.
6. Current drive response setting will be displayed briefly in the data display.

NOTE: Raising the seat bar or changing control mode (ISO / H) will cause the machine to disengage from drive response. The last displayed setting will remain in effect until the STOP button is pressed or the key is turned OFF.

DRIVE RESPONSE (CONT'D)

Operation (Cont'd)

Figure 46

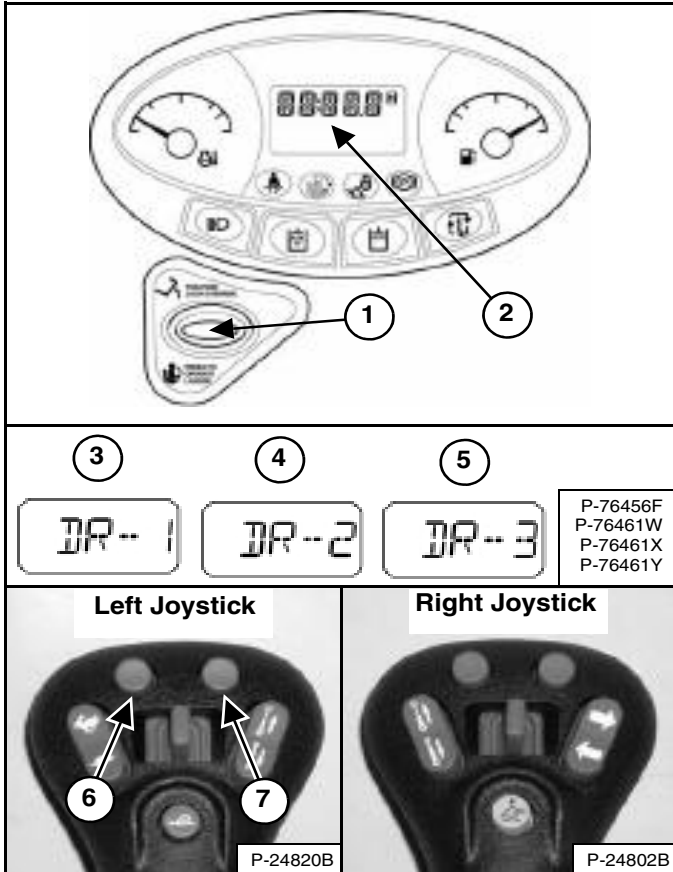

Press and hold the PRESS TO OPERATE LOADER button (Item 1) for **three seconds** to adjust the loader drive response setting. The current drive response setting will appear in the data display (Item 2) [Figure 46].

Press the upper left button (Item 6) on the left joystick to scroll down through the three settings. Press the upper right button (Item 7) on the left joystick to scroll up through the three drive response settings. The new drive response setting (Item 3, 4 or 5) will appear in the data display (Item 2) [Figure 46]. Adjustments to drive response will be effective immediately.

Figure 47

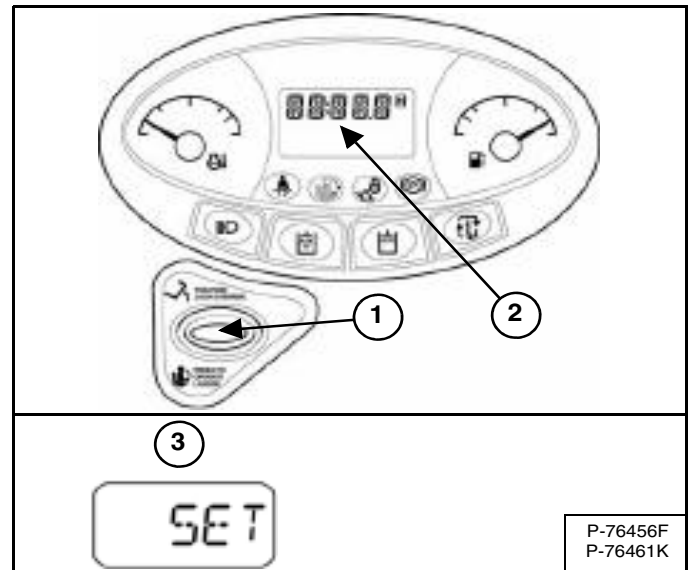

Saving The Drive Response Setting:

The current drive response setting can be saved by pressing and holding the PRESS TO OPERATE LOADER button (Item 1) for **three seconds**. [SET] (Item 3) will appear in the data display (Item 2) [Figure 47] and the machine will exit from the drive response adjustment menu.

OR

Press the PRESS TO OPERATE LOADER button to exit from the drive response adjustment menu without saving the current setting.

The current steering drift compensation setting (See STEERING DRIFT COMPENSATION on Page 57.) will appear in the data display (Item 2) [Figure 47] and the upper left and upper right buttons on the left joystick will no longer make changes to drive response.

NOTE: The last displayed drive response setting will remain in effect until the STOP button is pressed or the key is turned OFF. The machine will revert back to the last saved drive response setting the next time it is started.

Adjustments to steering drift compensation can now be made (See STEERING DRIFT COMPENSATION on Page 57.)

OR

Press the PRESS TO OPERATE LOADER button again to exit from the steering drift compensation menu.

STEERING DRIFT COMPENSATION

Steering Drift Compensation is available on SJC equipped machines.

Description

Steering Drift Compensation can be used to reduce steering drift to maintain a desired travel path in both forward and reverse directions.

Examples of applications where this feature can be used:

- To compensate for normal variations such as tyre inflation pressure, track tension, tyre wear and track wear.
- Using side shift attachments such as trenchers, planers and silt fence installers.
- Driving on uneven terrain such as crowned road surfaces.

Figure 48

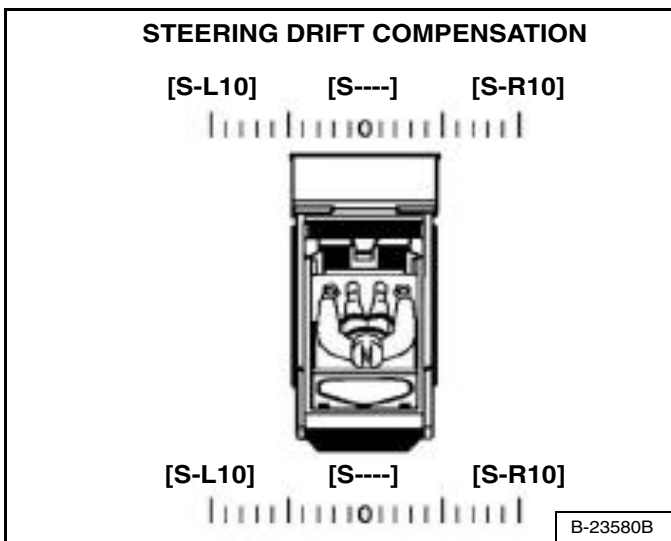

Steering drift compensation contains a total of 21 settings. Steering drift compensation can be set to any point from neutral to **[S-L10]** left and from neutral to **[S-R10]** right. **[S----]** is displayed when set for neutral **[Figure 48]**.

Operation

NOTE: Changes CANNOT be performed until the seat bar is lowered, the engine is started and the **PRESS TO OPERATE LOADER button is pressed to activate the BICS™.**

Perform pre-starting and starting procedures:

1. Fasten seat belt.
2. Lower seat bar.
3. Place joysticks in neutral position.
4. Start the engine.
5. Press the **PRESS TO OPERATE LOADER** button.
6. Current drive response setting will be displayed briefly in the data display.

NOTE: Raising the seat bar or changing control mode (ISO / H) will cause the machine to disengage from steering drift compensation. The last displayed setting will remain in effect until the **STOP button is pressed or the key is turned OFF.**

STEERING DRIFT COMPENSATION (CONT'D)

Operation (Cont'd)

Figure 49

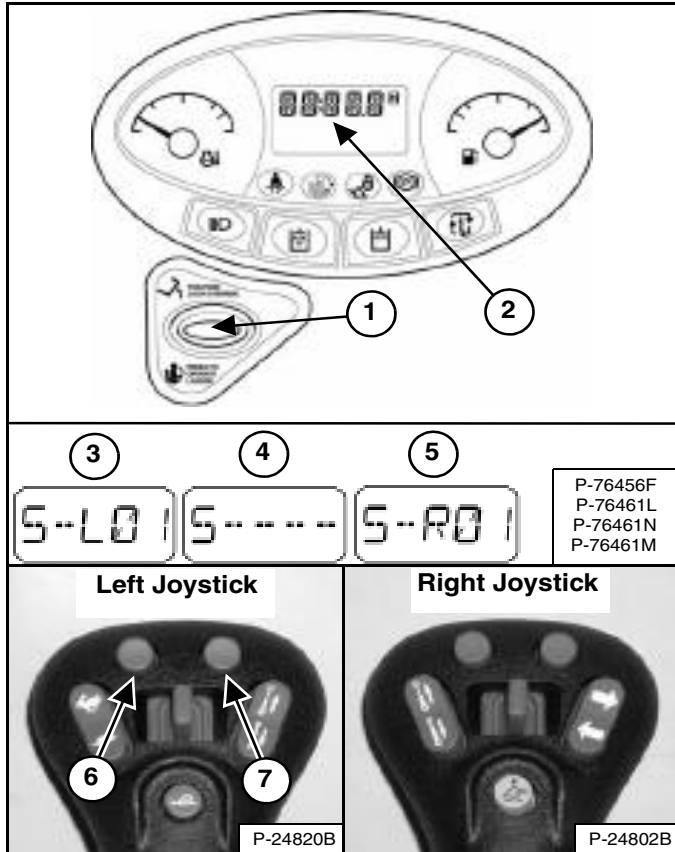

Press and hold the PRESS TO OPERATE LOADER button (Item 1) for **three seconds** to enter the drive response adjustment menu. Press the PRESS TO OPERATE LOADER button (Item 1) again to adjust the loader steering drift compensation setting. The current steering drift compensation setting will appear in the data display (Item 2) [Figure 49].

Press the upper left button (Item 6) on the left joystick to adjust the machine left. [S-L01] (Item 3) through a maximum of [S-L10] will appear in the data display (Item 2) [Figure 49]. The number will increase by one each time you press the button. The higher the number, the greater the amount of steering drift compensation to the left. Adjustments to steering drift compensation will be effective immediately.

Press the upper right button (Item 7) on the left joystick to adjust back toward centre. The display will decrease down to neutral displayed as [S----] (Item 4). Another press of the upper right button will cause [S-R01] (Item 5) to appear in the data display (Item 2) [Figure 49]. The number will increase by one each time you press the button up to a maximum of [S-R10]. The higher the number, the greater the amount of steering drift compensation to the right. Adjustments to steering drift compensation will be effective immediately.

Figure 50

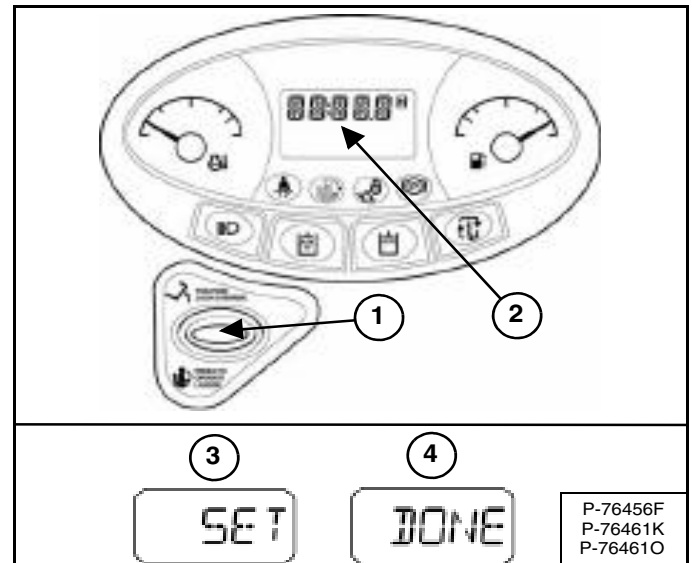

Saving The Steering Drift Compensation Setting:

The current steering drift compensation setting can be saved by pressing and holding the PRESS TO OPERATE LOADER button (Item 1) for **three seconds**. [SET] (Item 3) will appear in the data display (Item 2) [Figure 50] and the machine will exit from the steering drift compensation adjustment menu.

OR

Press the PRESS TO OPERATE LOADER button to exit from the steering drift compensation adjustment menu without saving the current setting. [DONE] (Item 4) will appear in the data display (Item 2) [Figure 50] and the upper left and upper right buttons on the left joystick will no longer make changes to steering drift compensation.

NOTE: The last displayed steering drift compensation setting will remain in effect until the STOP button is pressed or the key is turned OFF. The machine will revert back to the last saved setting the next time it is started.

HYDRAULIC CONTROLS

Description

Two foot pedals (or optional joysticks) control the hydraulic cylinders for the lift and tilt functions.

Put your feet on the pedals (or footrests) and KEEP THEM THERE any time you operate the loader.

Standard Controls

Figure 51

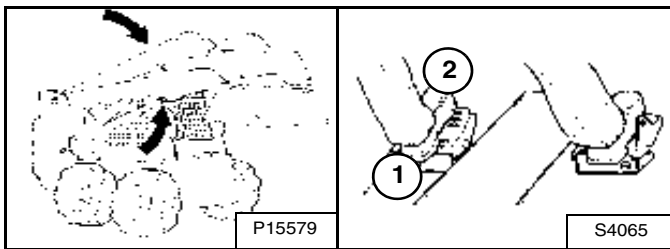

Lift Arm Operation (Left Pedal)

Push the heel (Item 1) [Figure 51] of the pedal to raise the lift arms.

Push the toe (Item 2) [Figure 51] of the pedal to lower the lift arms.

Lift Arm Float Position (Left Pedal)

Push the toe (Item 2) [Figure 51] of the pedal all the way forward until it locks into the float position.

Use the float position of the lift arms to level loose material while driving backward.

Raise the lift arms to disengage the float position.

Figure 52

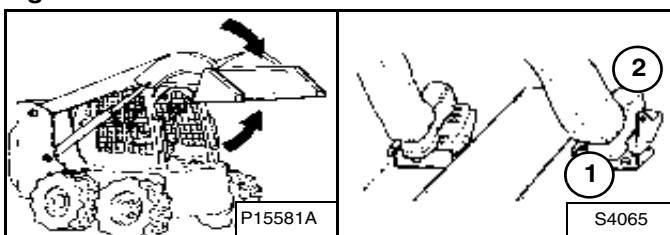

Tilt Operation - (Right Pedal)

Push the heel (Item 1) [Figure 52] of the pedal to tilt the bucket backward.

Push the toe (Item 2) [Figure 52] of the pedal to tilt the bucket forward.

Selectable Joystick Controls (SJC) In 'ISO' Control Pattern

Figure 53

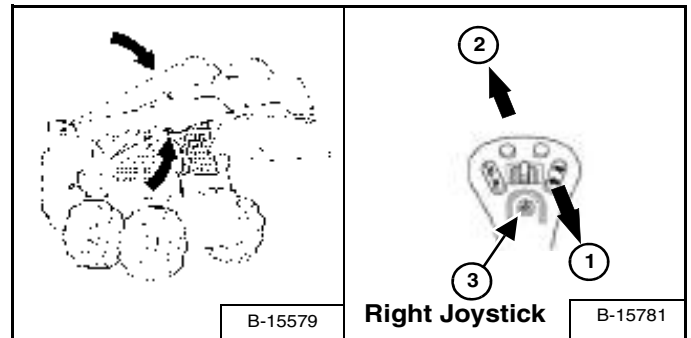

Lift Arm Operation - (Right Hand Joystick)

Move the joystick backward (Item 1) [Figure 53] to raise the lift arms.

Move the joystick forward (Item 2) [Figure 53] to lower the lift arms.

Lift Arm Float Position - (Right Hand Joystick)

Press and hold the Float button (Item 3) [Figure 53] while the joystick is in neutral. Move the joystick to lift arm down position (Item 2) [Figure 53], then release the button.

Press Float button (Item 3) again or move the joystick to lift arm up position (Item 1) [Figure 53] to disengage.

Use the float position of the lift arms to level loose material while driving backward.

Figure 54

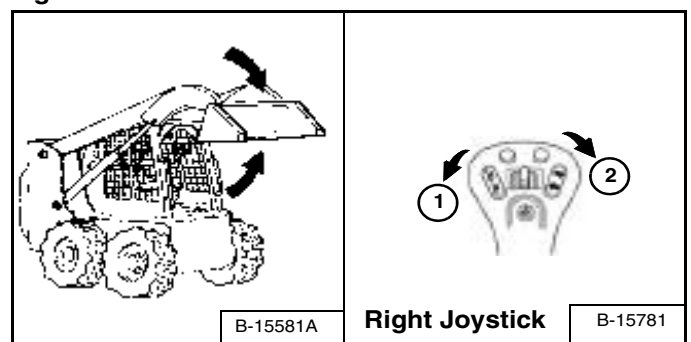

Tilt Operation - (Right Hand Joystick)

Move the joystick inward (Item 1) [Figure 54] to tilt the bucket backward.

Move the joystick outward (Item 2) [Figure 54] to tilt the bucket forward.

HYDRAULIC CONTROLS (CONT'D)

Selectable Joystick Controls (SJC) In 'H' Control Pattern

Figure 55

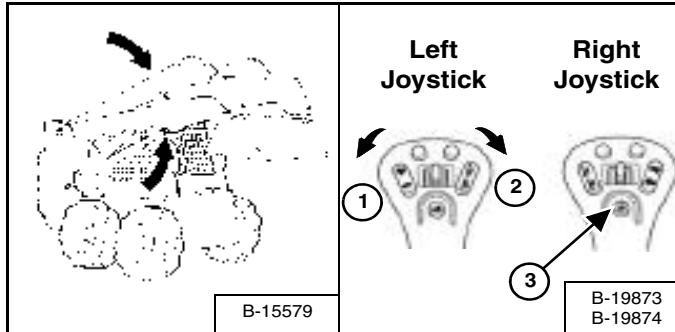

Lift Arm Operation - (Left Hand Joystick)

Move the joystick outward (Item 1) [Figure 55] to raise the lift arms.

Move the joystick inward (Item 2) [Figure 55] to lower the lift arms.

Lift Arm Float Position - (Left And Right Hand Joysticks)

Press and hold the Float button (Item 3) [Figure 55] while the joysticks are in neutral. Move the left joystick to lift arm down position (Item 2) [Figure 55], then release the button.

Press Float button (Item 3) [Figure 55] again or move the left joystick to lift arm up position to disengage.

Use the float position of the lift arms to level loose material while driving backward.

Figure 56

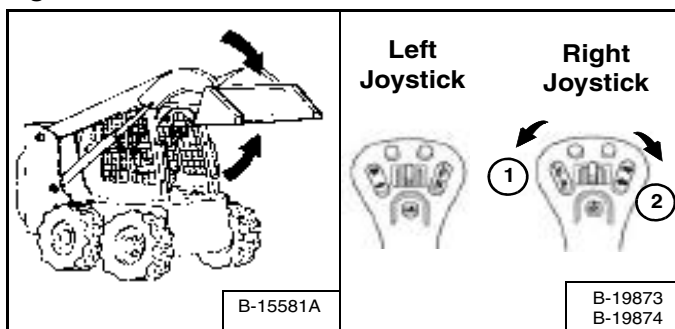

Tilt Operation - (Right Hand Joystick)

Move the joystick inward (Item 1) [Figure 56] to tilt the bucket backward.

Move the joystick outward (Item 2) [Figure 56] to tilt the bucket forward.

Hydraulic Bucket Positioning

The function of hydraulic bucket positioning is to keep the bucket in the same approximate position it is in before you begin raising the lift arms.

Figure 57

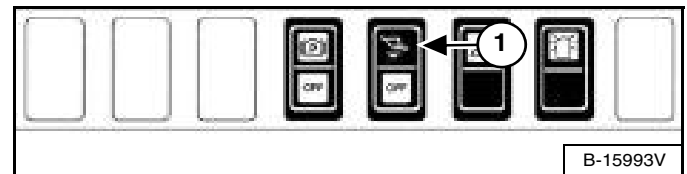

Press the top of the BUCKET POSITIONING switch (Item 1) [Figure 57] to engage the bucket positioning function. The amber light in the switch will turn on. Press the bottom of the switch to disengage. The amber light will turn off.

Bucket positioning functions only during upward lift cycle.

Front Auxiliary Hydraulic Control Lockout

Figure 58

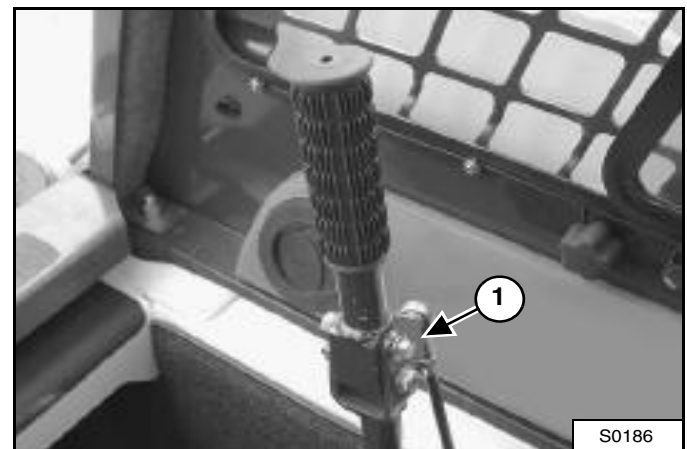

Remove the auxiliary hydraulic control lockout bolt and nut (Item 1) [Figure 58] before using the auxiliary control for the first time.

HYDRAULIC CONTROLS (CONT'D)

FRONT Auxiliary Hydraulics Operation (Variable Flow)

Variable Flow allows for slow-to-fast movement of auxiliary hydraulic functions.

Figure 59



Press the auxiliary hydraulics button (Item 1) [Figure 59] once to engage auxiliary hydraulics.

The light (Item 2) [Figure 59] will be ON.

Standard (If Equipped)

Figure 60

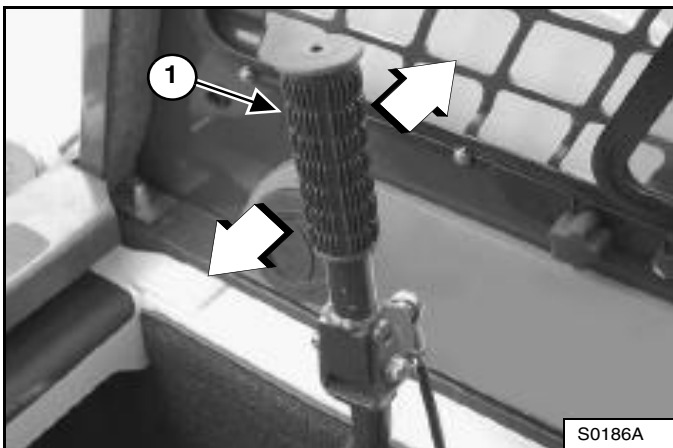

The handle of the right steering lever (Item 1) [Figure 60] is also the control lever for the front auxiliary hydraulics.

Move the handle (Item 1) [Figure 60] to the left for auxiliary hydraulic oil flow to the front male coupler. Hydraulic oil flow increases to the coupler as the handle is moved to the left.

Move the handle (Item 1) [Figure 60] to the right for auxiliary hydraulic oil flow to the front female coupler. Hydraulic oil flow increases to the coupler as the handle is moved to the right.

Move the handle to the neutral position to stop auxiliary hydraulic oil flow.

To disengage, press the auxiliary hydraulics button (Item 1) [Figure 59] again.

The light (Item 2) [Figure 59] will be OFF.

NOTE: When the operator is seated and raises the seat bar, the Auxiliary Hydraulic System will deactivate.

SJC (If Equipped)

Figure 61

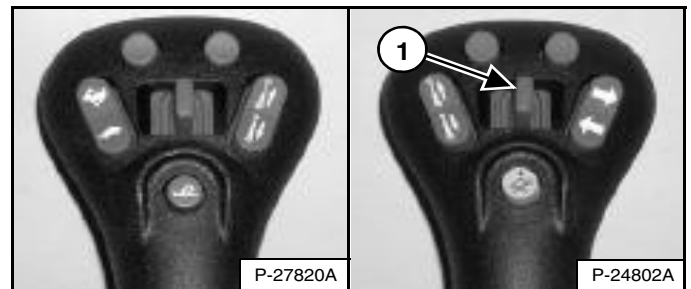

Move the front auxiliary hydraulic switch (Item 1) [Figure 61] to the right or left to change the fluid flow direction of the front quick couplers. If you move the switch half-way, the auxiliary functions move at approximately one-half speed; release the switch to stop auxiliary functions. (EXAMPLE: Open and close grapple teeth.)

To disengage, press the auxiliary hydraulics button (Item 1) [Figure 59] again.

The light (Item 2) [Figure 59] will be OFF.

NOTE: When the operator is seated and raises the seat bar, the Auxiliary Hydraulic System (Front and Rear) will deactivate.

HYDRAULIC CONTROLS (CONT'D)

FRONT Auxiliary Hydraulics Operation (Continuous Flow)

Continuous Flow allows for a constant flow of auxiliary hydraulic oil to an attachment.

Figure 62



Press the auxiliary hydraulics button (Item 1) [Figure 62] once to engage auxiliary hydraulics.

The light (Item 2) [Figure 62] will be ON.

Standard (If Equipped)

Figure 63

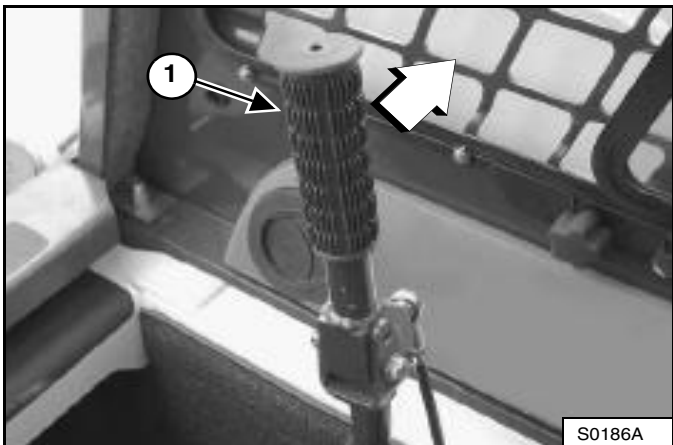

Move the handle of the right steering lever (Item 1) [Figure 63] fully to the right to put it into continuous flow (detent) position. This will allow constant auxiliary hydraulic oil flow to the female coupler.

Move the handle to the neutral position to stop auxiliary hydraulic oil flow.

Move the handle out of the continuous flow (detent) position before leaving the operator's seat.

To disengage, press the auxiliary hydraulics button (Item 1) [Figure 62] again.

The light (Item 2) [Figure 62] will be OFF.

NOTE: When the operator is seated and raises the seat bar, the Auxiliary Hydraulic System will deactivate.

SJC (If Equipped)

Figure 64

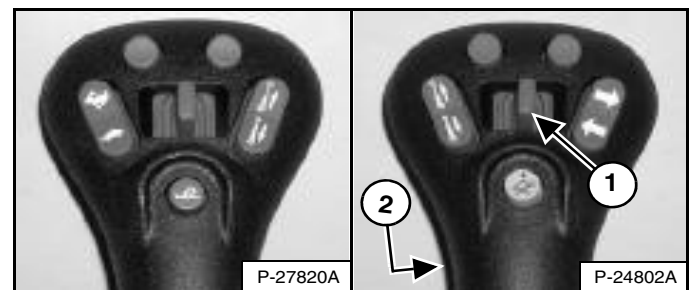

Press the front switch (Item 2) [Figure 64] to give the front quick couplers a constant flow of fluid with the female coupler being pressurised. (EXAMPLE: Operate a backhoe.)

REVERSE CONTINUOUS FLOW - To set reverse flow (male coupler pressurised), engage auxiliary hydraulics, then, while holding the auxiliary switch (Item 1) to the left, press the front switch (Item 2) [Figure 64].

NOTE: Reverse flow can cause damage to some attachments. Use reverse flow with your attachment only if approved. See your attachment Operation & Maintenance Manual for detailed information.

To release from continuous operation, press the front switch (Item 2) [Figure 64] a second time.

NOTE: When the operator is seated and raises the seat bar, the Auxiliary Hydraulic System (Front and Rear) will deactivate.

HYDRAULIC CONTROLS (CONT'D)

Quick Couplers

! WARNING

AVOID BURNS

Hydraulic fluid, tubes, fittings and quick couplers can get hot when running machine and attachments. Be careful when connecting and disconnecting quick couplers.

W-2220-0396

! WARNING

AVOID INJURY OR DEATH

Diesel fuel or hydraulic fluid under pressure can penetrate skin or eyes, causing serious injury or death. Fluid leaks under pressure may not be visible. Use a piece of cardboard or wood to find leaks. Do not use your bare hand. Wear safety goggles. If fluid enters skin or eyes, get immediate medical attention from a doctor familiar with this injury.

W-2072-EN-0909

Standard (If Equipped)

Figure 65



SJC (If Equipped)

Figure 66

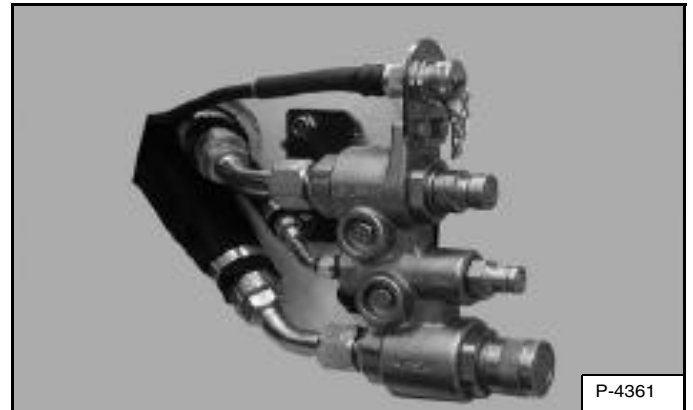

To Connect: Remove dirt or debris from the surface of both the male and female couplers, and from the outside diameter of the male coupler. Visually check the couplers for corroding, cracking, damage or excessive wear. If any of these conditions exist, the coupler(s) [Figure 65] or [Figure 66] must be replaced.

Install the male coupler into the female coupler. Full connection is made when the ball release sleeve slides forward on the female coupler.

To Disconnect: Hold the male coupler. Retract the sleeve on the female coupler until the couplers disconnect.

HYDRAULIC CONTROLS (CONT'D)

Relieve Auxiliary Hydraulic Pressure (Loader And Attachment)

Hydraulic pressure can make it difficult to connect or disconnect quick couplers.

Put the attachment flat on the ground.

Stop the engine and turn the key to RUN or press the RUN button, but do not start the engine.

Figure 67



Press the auxiliary hydraulics button (Item 1) [Figure 67].

Standard (If Equipped)

Figure 68

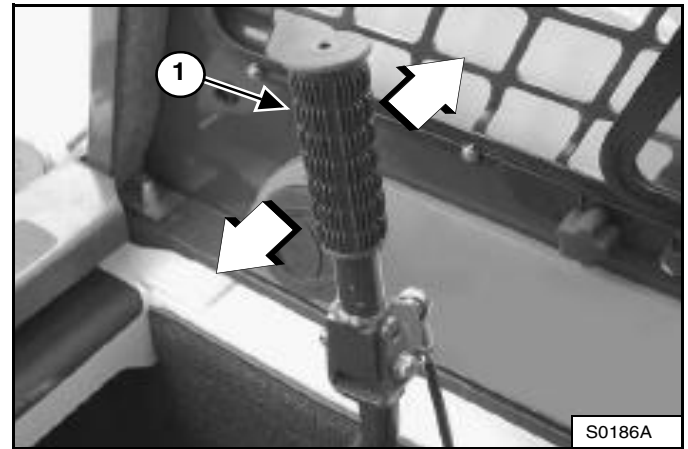

Move the right steering lever handle (Item 1) [Figure 68] to the right and left several times.

Press the auxiliary hydraulics button (Item 1) [Figure 67] again.

Turn the key to OFF or press the STOP button.

SJC (If Equipped)

When Connecting: Push the quick couplers tightly together and hold for five seconds; the pressure is automatically relieved as the couplers are installed.

When Disconnecting: Push the quick couplers tightly together and hold for five seconds; then retract the sleeve until the couplers disconnect.

ATTACHMENT CONTROL DEVICE (ACD)

This machine may be equipped with an Attachment Control Device.

Description

Figure 69

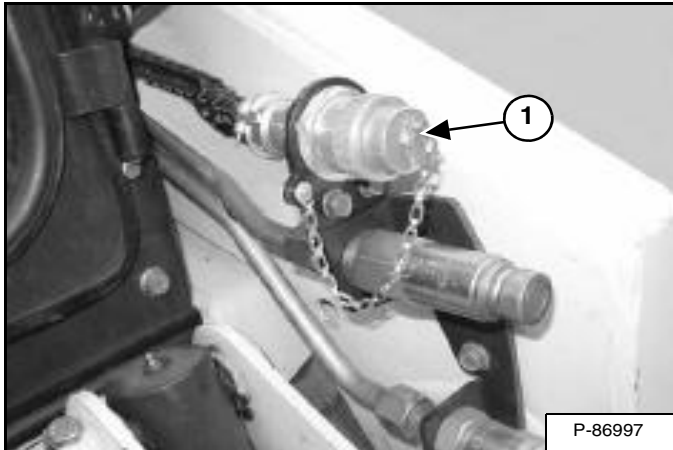

Connect the attachment electrical harness to the attachment control device (Item 1) [Figure 69].

Standard (If Equipped)

Figure 70

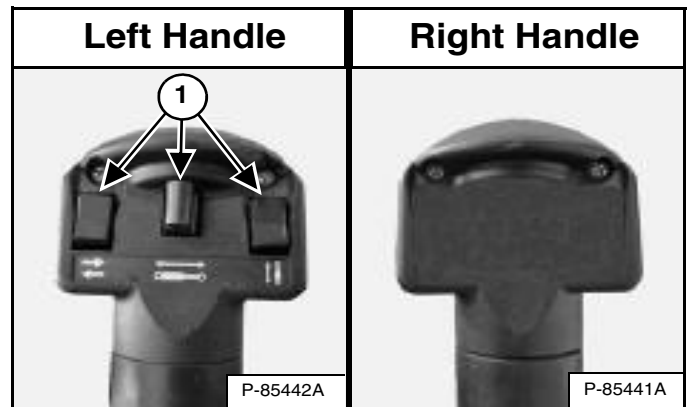

Additional switches (Item 1 [Figure 70] on the left steering lever handle are used to control some attachment functions through the attachment control device.

See the appropriate attachment Operation & Maintenance Manual for control details.

SJC (If Equipped)

Figure 71

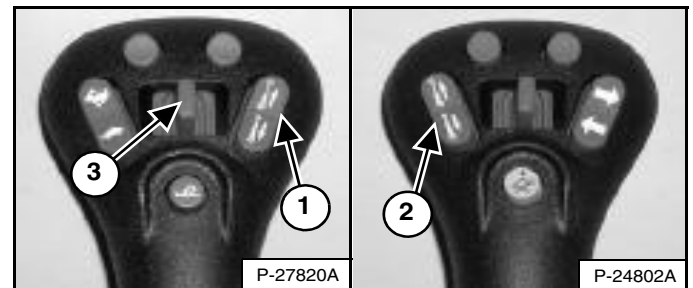

Additional switches (Items 1, 2 and 3) [Figure 71] on the right and left joysticks are used to control some attachment functions through the attachment control device.

See the appropriate attachment Operation & Maintenance Manual for control details.



DAILY INSPECTION

Figure 72

WARNING

Keep door closed except for service.

Keep engine clean of flammable material.

Keep body, loose objects and clothing away from electrical contacts, moving parts, hot parts and exhaust.

Do not use loader in space with explosive dusts or gases or with flammable material near exhaust.

Never use ether or starting fluid on diesel engine with glow plugs. Use only starting aids as approved by engine manufacturer.

Leaking fluids under pressure can enter skin and cause serious injury.

Battery acid causes severe burns; wear goggles. If acid contacts eyes, skin, or clothing, flush with water. For contact with eyes, flush and get medical attention.

Battery makes flammable and explosive gas. Keep arcs, sparks, flames and lit cigarettes away.

For jump start, connect negative cable to loader engine last (never at the battery). After jump start, remove negative connection at the engine first.

Exhaust gases can kill. Always ventilate.

SERVICE CHECKLIST AND SCHEDULE

EVERY 10 HRS (BEFORE STARTING THE LOADER)

- **ENGINE OIL & FILTER** - Check level and add as needed. Do not overfill. Change oil and filter after first 50 Hrs. then refer to Operation & Maintenance Manual for proper change interval for your Model.
- **ENGINE AIR FILTER** - Check condition indicator and/or display. Service only when required. Do not use compressed air to clean elements.
- **ENGINE AIR SYSTEM** - Check for leaks and damaged components.
- **ENGINE COOLING SYSTEM** - Clean debris from gills, oil cooler and radiator. Check coolant level and add; add coolant mixture if required.
- **FUEL FILTER** - Remove trapped water.
- **LOWER LIFT ARMS, LIFT LINKS, CYLINDERS, BOB-TACH PIVOT & WEDGES, STEERING CYLINDERS (AWS Machine Only)** - Lubricate with multipurpose lithium based grease.
- **SEAT BELT, SEAT BAR AND CONTROL INTERLOCKS** - Check function. Repair or replace as needed. Clean dirt and debris from moving parts.
- **BACK** - Check for correct function. Clean dirt and debris from moving parts. LR and TR functions MUST NOT operate with seat belt retracted.
- **TIRES** - Check for pressure. Refer to MAINTENANCE pressure chart on back of lift.
- **GENERAL** - Check for loose or broken parts, damaged operator cch, instrument operation, loose wheel nuts or track sprocket nuts, oil leaks, damaged or missing safety signs (labels).

EVERY 50 HRS

- **HYDRAULIC FLUID, HOSES AND TUBING** - Check fluid level and add if required. Check for damage and for leaks. Repair or replace as needed.
- **FINAL DRIVE TRANSMISSION (CHASSIS, Wheel Machines Only)** - Check fluid level and add if required.
- **HYDRAULIC & STEERING CONTROLS (PEDALS, HAND, and/or JOYSTICK)** - Check for correct operation. Adjust as needed.
- **WHEEL AUTO / TRACK DRIVE SPROCKETS** - Check for loose pins and tighten as needed.
- **TRACK TENSION (Track Machines Only)** - Check tension and adjust as needed.

EVERY 100 HRS

- **SPARK ARRESTOR MUFFLER** - Empty soot, clean, (if equipped).
- **BATTERY** - Check battery for damage, held down clamps, cables, connections and electrolyte level. Add distilled water as needed.
- **DRIVE LINE** - Lubricate Engine-In-Pump Coupler with multipurpose lithium based grease. (if equipped)

EVERY 200 HRS

- **STEERING LEVER PISTON** - Lubricate with multipurpose lithium based grease. (if equipped)
- **FUEL FILTER** - Replace filter.
- **WIND PUMP (AWS Machine Only)** - Lubricate with multipurpose lithium based grease.
- **ENGINE / HYDRAULIC DRIVE BELT** - Check for wear or damage. Adjust or replace as needed. (if equipped)
- **RAIL DRIVE GEARBOX** - Check fluid level and add if required. (if equipped)
- **OTHER DRIVE BELTS** (Hydraulic pump, water pump, alternator, and air conditioner - if equipped) - Check condition and tension. Adjust or replace as needed.
- **BIOS** - Check function of LR Arm By-Pass control.

EVERY 500 HRS

- **FAW / HYDRAULIC / HYDROSTATIC SYSTEM** - Replace filter. Replace reverse breakout cap.
- **STEERING VALVE INLINE FILTER (AWS Only)** - Replace filter.
- **HYDROSTATIC MOTOR CARRIER (Track Machines Only)** - Replace oil.

EVERY 1000 HRS

- **HYDRAULIC RESERVOIR** - Replace fluid.
- **FINAL DRIVE TRANSMISSION (Chassis on Wheel Machines Only)** - Replace fluid
- **TRACK ROLLER, IDLER ASSEMBLIES (Track Machines Only)** - Replace fluid (if required).
- **DRIVE MOTOR CASE DRAIN FILTER** - Replace filter (if equipped)
- **WHEEL BEARING & OUTER SPLINES (AWS only)** - Repack wheel bearings, grease internal splines in hub yokes (Dealer Service Only)

NOTES:

- Replace operator ccessor if transmission spinning indicator remains on for more than 5 minutes after hydraulic fluid is at operating temperature.
- Service at first 50 Hours, then as scheduled.
- See Operation & Maintenance Manual for correct fluid specifications, filter part number and location, and appropriate service interval for your Model.

GENERAL LUBRICATION DIAGRAMS

RADIUS PATH MACHINE

VERTICAL PATH MACHINE

• **TYPICAL GREASE POINTS**

Use Genuine Bobcat Replacement Parts

7204H SW
© 2018 Bobcat Corporation 6734534-01

SEE OPERATION & MAINTENANCE MANUAL FOR MORE INFORMATION AND INSTRUCTIONS.

6734534-V



DAILY INSPECTION (CONT'D)

Daily Inspection And Maintenance

Maintenance work must be done at regular intervals. Failure to do so will result in excessive wear and early failures. The Service Schedule [Figure 72] is a guide for correct maintenance of the Bobcat loader. It is located inside the rear door of the loader.

- Engine Oil Level
- Hydraulic / Hydrostatic Fluid Level
- Engine Air Filter - Check System for Damage or Leaks
- Engine Coolant Level - Check System for Damage or Leaks
- Operator Cab and Cab Mounting Hardware
- Seat Belt
- Seat Bar and Control Interlocks
- Bobcat Interlock Control System (BICS™)
- Front Horn - Check for proper function
- Grease Pivot Pins (Lift Arms, Bob-Tach, Cylinders, Bob-Tach Wedges)
- Tracks - Check for Wear or Damage
- Fuel Filter - Remove Trapped Water
- Loose or Broken Parts - Repair or Replace as necessary
- Safety Treads and Safety Signs (Decals) - Replace as necessary
- Lift Arm Support Device - Replace if damaged

WARNING

Operator must have instructions before operating the machine. Untrained operators can cause injury or death.

W-2001-0502

NOTE: Fluids such as engine oil, hydraulic fluid, coolant, etc. must be disposed of in an environmentally safe manner. Some regulations require that certain spills and leaks on the ground must be cleaned in a specific manner. See local bylaws for correct disposal.

IMPORTANT

PRESSURE WASHING DECALS

- Never direct the stream at a low angle toward the decal that could damage the decal causing it to peel from the surface.
- Direct the stream at a 90 degree angle and at least 300 mm (12 in) from the decal. Wash from the centre of the decal toward the edges.

I-2226-EN-0910

PRE-STARTING PROCEDURE

Entering The Loader

Figure 73



Use the bucket or attachment steps, grab handles and safety treads (on the loader lift arms and frame) to get on and off the loader [Figure 73]. Do not jump.

Safety treads are installed on the Bobcat loader to provide a slip resistant surface for getting on and off the loader.

Keep safety treads clean and replace when damaged. Replacement treads are available from your Bobcat dealer.

Operation & Maintenance Manual And Operator's Handbook Locations

Figure 74

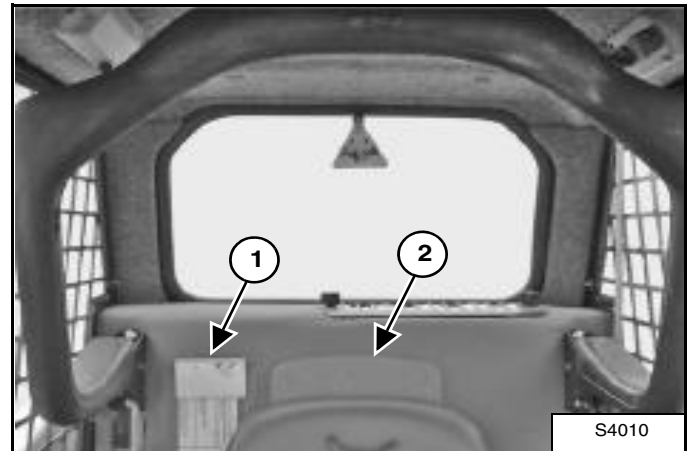

Read and understand the Operation & Maintenance Manual and the Operator's Handbook (Item 1) [Figure 74] before operating the loader.

The Operation & Maintenance Manual and other manuals can be kept in a container (Item 2) [Figure 74] provided behind the operator seat.

WARNING

AVOID INJURY OR DEATH

Instructions are necessary before operating or servicing machine. Read and understand the Operation & Maintenance Manual, Operator's Handbook and signs (decals) on machine. Follow warnings and instructions in the manuals when making repairs, adjustments or servicing. Check for correct function after adjustments, repairs or service. Untrained operators and failure to follow instructions can cause injury or death.

W-2003-0807

PRE-STARTING PROCEDURE (CONT'D)

Seat Adjustment

Figure 75

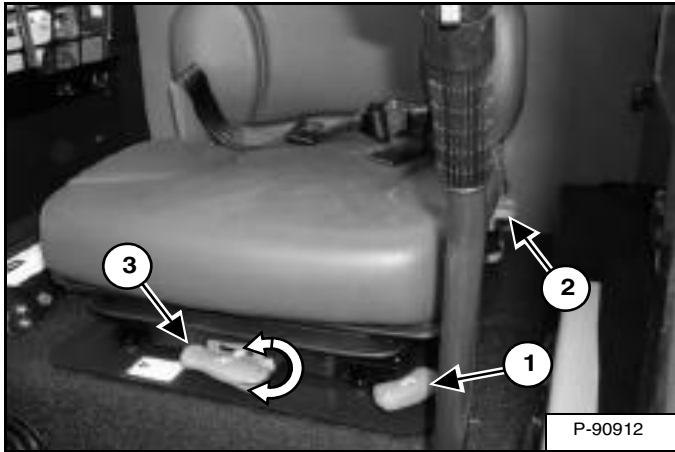

Pull the lever (Item 1) [Figure 75] up to adjust the seat position for comfortable operation of the loader controls.

Pull the lever (Item 2) [Figure 75] up to adjust the angle of the seat back.

Turn the lever (Item 3) [Figure 75] to adjust the seat cushion for weight of the operator.

Figure 76



Air Ride Suspension Seat - (Option) Turn the knob (Item 1) [Figure 76] to adjust the angle of the seat back.

Turn the knob (Item 2) [Figure 76] to adjust the lumbar support.

Push the knob (Item 3) [Figure 76] in and hold to increase the amount of air in the seat suspension. Pull the knob out and hold to decrease the amount of air in the seat suspension.

NOTE: The loader's electrical system must be turned ON to increase the amount of air in the seat suspension.

Pull the lever (Item 4) [Figure 76] up to adjust the seat position for comfortable operation of the loader controls.

PRE-STARTING PROCEDURE (CONT'D)

Seat Belt Adjustment

Figure 77

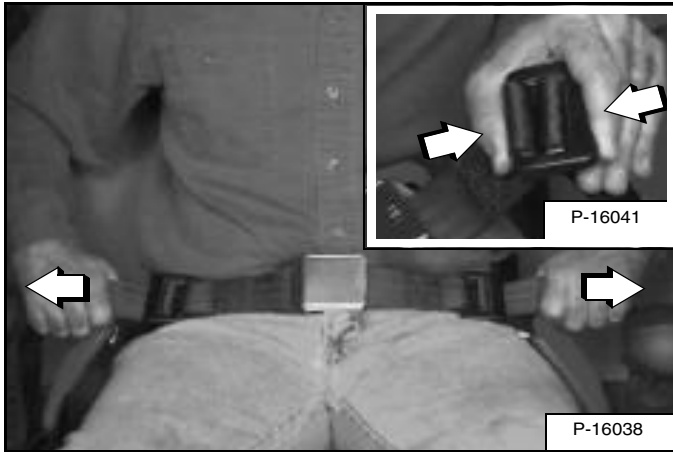

Squeeze both seat belt adjusters to release and lengthen each half of the seat belt [Figure 77].

Fasten the seat belt.

Pull the ends of the belt through the belt adjusters so that the seat belt is snug and the buckle is centred between your hips [Figure 77].

Figure 78

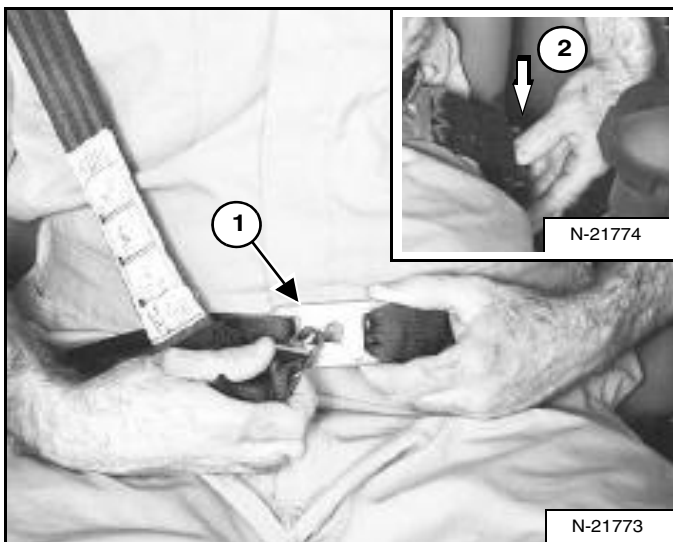

3-Point Restraint - (Option) Connect the shoulder belt to the lap belt (Item 1) [Figure 78]. Pull the lap belt across to the left side of the seat (Item 2) [Figure 78] and fasten.

The shoulder belt must be positioned over your right shoulder and lap belt over your lower hips [Figure 78].

IMPORTANT

Check the seat belt and shoulder belt retractors for correct operation.

Keep retractors clean and replace as necessary.

I-2199-0200

Seat Bar

Figure 79



Lower the seat bar and engage the parking brake [Figure 79].

Put the foot pedals and steering levers in neutral position.

NOTE: Keep your hands on the steering levers and your feet on the foot pedals (or footrests) while operating the loader.

! WARNING

AVOID INJURY OR DEATH

When operating the machine:

- Keep the seat belt fastened snugly.
- The seat bar must be lowered.
- Keep your feet on the pedal controls or footrests and hands on the controls.

W-2261-0909

STARTING THE ENGINE

Standard Key Panel



AVOID INJURY OR DEATH

- Engines can have hot parts and hot exhaust gas. Keep flammable material away.
- Do not use machines in atmosphere containing explosive gas.

W-2051-1086

Perform the PRE-STARTING PROCEDURE. (See PRE-STARTING PROCEDURE on Page 68.)

Figure 80



Move the speed control lever (Item 1) [Figure 80] to the idle position.

Figure 81



Turn the key switch to RUN (Item 1) [Figure 81]. The indicator lights on the left instrument panel will come ON briefly and the Instrument Panel / monitoring system will do a self test.

Figure 82

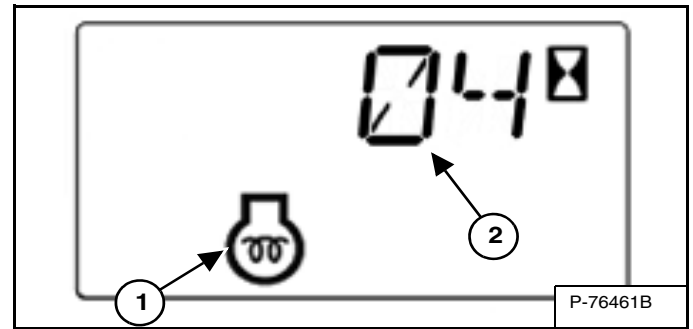

The machine will cycle the air intake heater (glow plugs) automatically based on temperature. The engine preheat icon (Item 1) will be ON and the cycle time remaining will show in the data display (Item 2) [Figure 82].

When the engine preheat icon goes OFF, turn the key switch to START (Item 2). Release the key when the engine starts and allow it to return to the RUN position (Item 1) [Figure 81].

NOTE: Make sure both joysticks (SJC) are in the neutral position before starting the engine. Do not move the joysticks from the neutral position when turning the key to RUN or START with the BICS™ activated.



AVOID INJURY OR DEATH

- Fasten seat belt, start and operate only from the operator's seat.
- Never wear loose clothing when working near machine.

W-2135-1108

STARTING THE ENGINE (CONT'D)

Standard Key Panel (Cont'd)

Figure 83

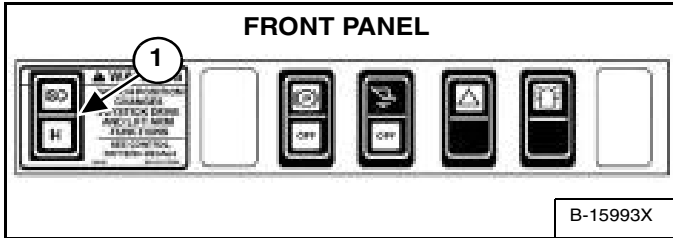

(SJC) Select 'ISO' or 'H' Control Pattern (Item 1) [Figure 83].

Figure 84

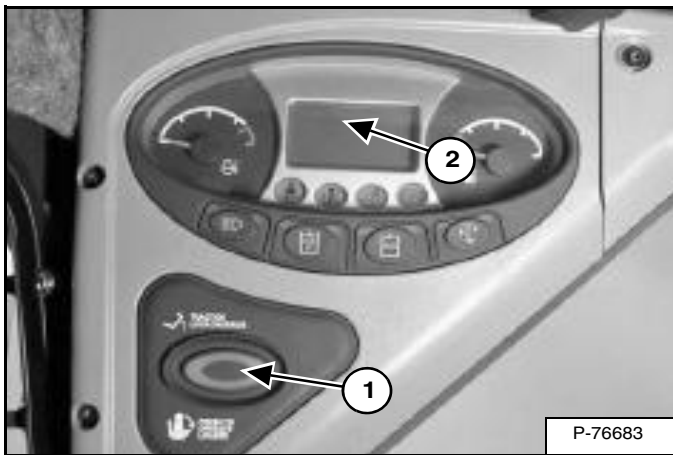

Press the PRESS TO OPERATE LOADER button (Item 1) [Figure 84] to activate the BICS™ and to perform hydraulic and loader functions.

(SJC) The current drive response setting will be displayed briefly in the data display (Item 2) each time the PRESS TO OPERATE LOADER button (Item 1) [Figure 84] is pressed.

NOTE: (SJC) The light of the current switch position (ISO or H) will flash, which will indicate PRESS TO OPERATE LOADER is required. The light will flash when the key switch is ON and continue to flash until the PRESS TO OPERATE LOADER button is pressed, thereafter the light will become solid. If the mode (ISO / H) is changed while driving, the active mode light will remain solid and the pending mode light will flash. When operation of the machine is returned to neutral, the active mode light will then turn off and the pending mode light will continue to flash until the PRESS TO OPERATE LOADER button is pressed.

! WARNING

AVOID INJURY OR DEATH

When an engine is running in an enclosed area, fresh air must be added to avoid concentration of exhaust fumes. If the engine is stationary, vent the exhaust outside. Exhaust fumes contain odorless, invisible gases which can kill without warning.

W-2050-0807

STARTING THE ENGINE (CONT'D)

Keyless Start Panel



AVOID INJURY OR DEATH

- Engines can have hot parts and hot exhaust gas. Keep flammable material away.
- Do not use machines in atmosphere containing explosive gas.

W-2051-1086

Perform the PRE-STARTING PROCEDURE. (See PRE-STARTING PROCEDURE on Page 68.)

Figure 85



Set the engine speed control to the idle position [Figure 85]

NOTE: Loaders with a Keyless Start Panel have a permanent, randomly generated Master Password set at the factory. Your loader will have an Owner Password. The password can be changed to prevent unauthorised use of your loader. (See Password Lockout Feature on Page 159.) Keep your password in a safe place for future needs.

NOTE: The Password Lockout feature can be used to allow starting of the loader without a password. (See Password Lockout Feature on Page 159.)

Figure 86

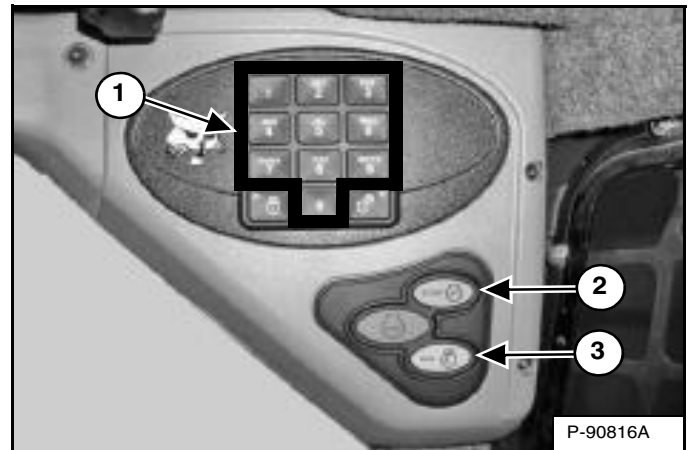

Press the RUN button (Item 3) [Figure 86].

Use the numeric keypad (Item 1) to enter the password, then press the RUN button (Item 3) [Figure 86].

Figure 87

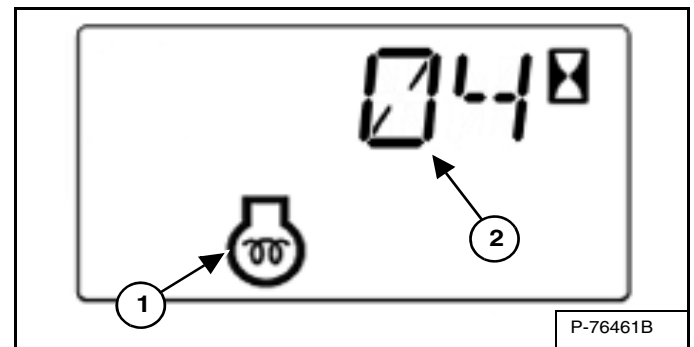

The machine will cycle the air intake heater (glow plugs) automatically based on temperature. The engine preheat icon (Item 1) will be ON and the cycle time remaining will show in the data display (Item 2) [Figure 87].

When the engine preheat icon goes OFF, press the START button (Item 2) [Figure 86]. Release the button when the engine starts.

STARTING THE ENGINE (CONT'D)

Keyless Start Panel (Cont'd)

NOTE: Make sure both joysticks (SJC) are in the neutral position before starting the engine. Do not move the joysticks from the neutral position when turning the key to RUN or START with the BICS™ activated.

Figure 88

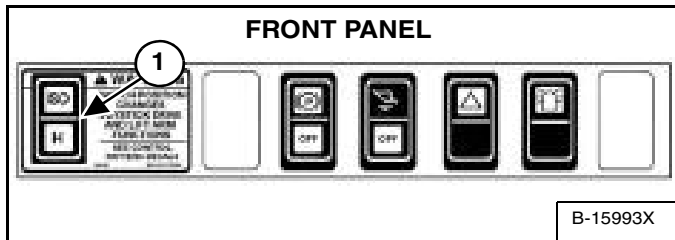

(SJC) Select 'ISO' or 'H' Control Pattern (Item 1) [Figure 88].

Figure 89

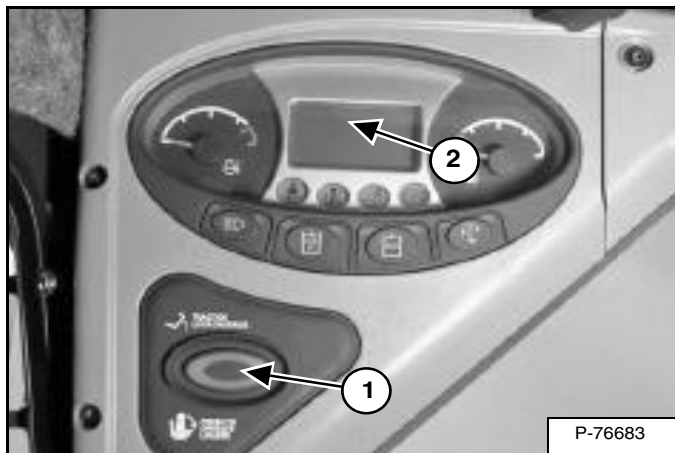

Press the PRESS TO OPERATE LOADER button (Item 1) [Figure 89] to activate the BICS™ and to perform hydraulic and loader functions.

(SJC) The current drive response setting will be displayed briefly in the data display (Item 2) each time the PRESS TO OPERATE LOADER button (Item 1) [Figure 89] is pressed.

NOTE: (SJC) The light of the current switch position (ISO or H) will flash, which will indicate PRESS TO OPERATE LOADER is required. The light will flash when the RUN button has been pressed and continue to flash until the PRESS TO OPERATE LOADER button is pressed, thereafter the light will become solid. If the mode (ISO / H) is changed while driving, the active mode light will remain solid and the pending mode light will flash. When operation of the machine is returned to neutral, the active mode light will then turn off and the pending mode light will continue to flash until the PRESS TO OPERATE LOADER button is pressed.



AVOID INJURY OR DEATH

When an engine is running in an enclosed area, fresh air must be added to avoid concentration of exhaust fumes. If the engine is stationary, vent the exhaust outside. Exhaust fumes contain odorless, invisible gases which can kill without warning.

W-2050-0807

STARTING THE ENGINE (CONT'D)

Deluxe Instrumentation Panel



AVOID INJURY OR DEATH

- Engines can have hot parts and hot exhaust gas. Keep flammable material away.
- Do not use machines in atmosphere containing explosive gas.

W-2051-1086

Perform the PRE-STARTING PROCEDURE. (See PRE-STARTING PROCEDURE on Page 68.)

Figure 90



Move the speed control lever (Item 1) [Figure 90] to the idle position.

NOTE: Loaders with a Deluxe Instrumentation Panel have a permanent, randomly generated Master Password set at the factory. Your loader will be assigned an Owner Password. Your dealer will provide you with this password. Change the password to one that you will easily remember to prevent unauthorised use of your loader. (See Changing The Owner Password on Page 159.) Keep your password in a safe place for future needs.

NOTE: The Password Lockout feature can be used to allow starting of the loader without a password. (See Password Lockout Feature on Page 159.)

Figure 91

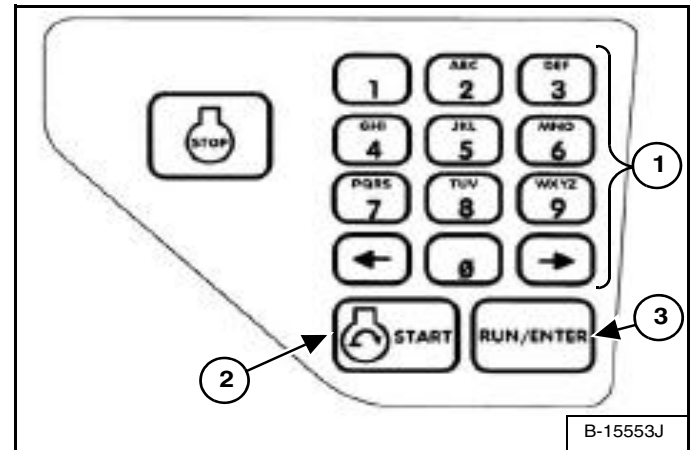

Press the RUN / ENTER button (Item 3) [Figure 91].

Use the numeric keypad (Item 1) to enter the password, then press the RUN / ENTER button (Item 3) [Figure 91].

Figure 92

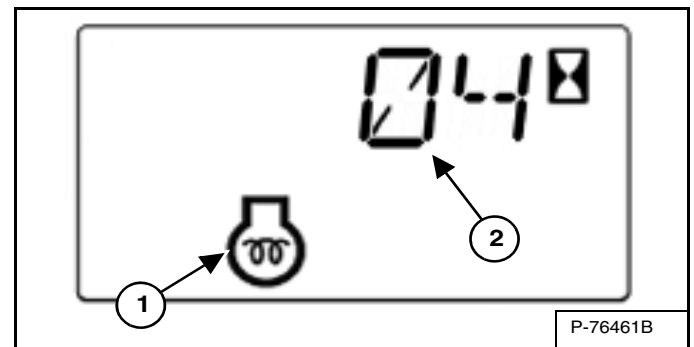

The machine will cycle the air intake heater (glow plugs) automatically based on temperature. The engine preheat icon (Item 1) will be ON and the cycle time remaining (Item 2) [Figure 92] will show in the data display.

When the engine preheat icon goes OFF, press the START button (Item 2) [Figure 91]. Release the button when the engine starts.

STARTING THE ENGINE (CONT'D)

Deluxe Instrumentation Panel (Cont'd)

NOTE: Make sure both joysticks (SJC) are in the neutral position before starting the engine. Do not move the joysticks from the neutral position when pressing the RUN / ENTER or START buttons with the BICS™ activated.

Figure 93

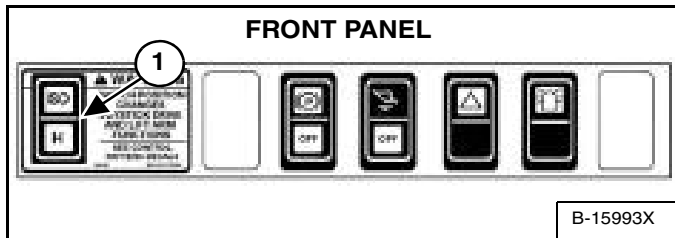

(SJC) Select 'ISO' or 'H' Control Pattern (Item 1) [Figure 93].

Figure 94

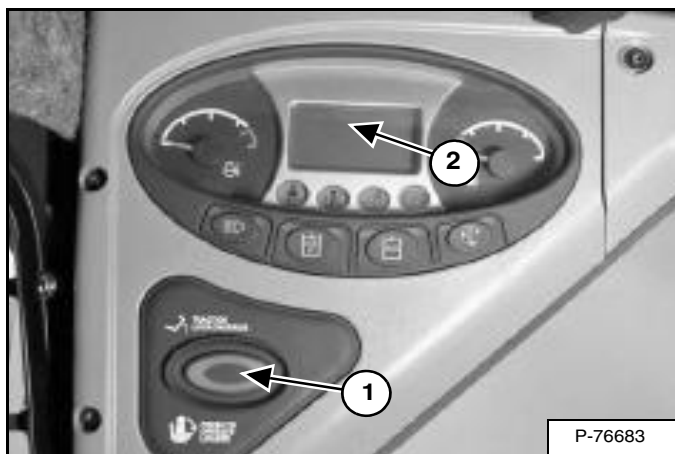

Press the PRESS TO OPERATE LOADER button (Item 1) [Figure 94] to activate the BICS™ and to perform hydraulic and loader functions.

(SJC) The current drive response setting will be displayed briefly in the data display (Item 2) each time the PRESS TO OPERATE LOADER button (Item 1) [Figure 94] is pressed.

NOTE: (SJC) The light of the current switch position (ISO or H) will flash, which will indicate PRESS TO OPERATE LOADER is required. The light will flash when the RUN button has been pressed and continue to flash until the PRESS TO OPERATE LOADER button is pressed, thereafter the light will become solid. If the mode (ISO / H) is changed while driving, the active mode light will remain solid and the pending mode light will flash. When operation of the machine is returned to neutral, the active mode light will then turn off and the pending mode light will continue to flash until the PRESS TO OPERATE LOADER button is pressed.

WARNING

AVOID INJURY OR DEATH

When an engine is running in an enclosed area, fresh air must be added to avoid concentration of exhaust fumes. If the engine is stationary, vent the exhaust outside. Exhaust fumes contain odorless, invisible gases which can kill without warning.

W-2050-0807

STARTING THE ENGINE (CONT'D)

Cold Temperature Starting

! WARNING

AVOID INJURY OR DEATH

Do not use ether with glow plug (preheat) systems. Explosion can result which can cause injury, death, or severe engine damage.

W-2071-0907

If the temperature is below freezing, perform the following to make starting the engine easier:

- Replace the engine oil with the correct type and viscosity for the anticipated starting temperature. (See Engine Oil Chart on Page 124.)
- Make sure the battery is fully charged.
- Install an engine heater, available from your Bobcat loader dealer.
- Move engine speed control lever halfway before starting. Return to idle position after the engine starts.

NOTE: The display screen of the Deluxe Instrumentation Panel may not be immediately visible when the temperature is below -26°C (-15°F). It may take 30 seconds to several minutes for the display screen to warm up. All systems remain monitored even when the display screen is off.

Warming The Hydraulic / Hydrostatic System

IMPORTANT

When the temperature is below -30°C (-20°F), hydrostatic oil must be warmed before starting. The hydrostatic system will not get enough oil at low temperatures and will be damaged. Park the machine in an area where the temperature will be above -18°C (0°F) if possible.

I-2007-0910

Let the engine run for a minimum of five minutes to warm the engine and hydrostatic transmission fluid before operating the loader.

MONITORING THE DISPLAY PANELS

Left Panel

Figure 95



Frequently monitor the temperature and fuel gauges and BICS™ lights (all BICS™ lights must be OFF to operate loader) [Figure 95].

After the engine is running, frequently monitor the left instrument panel [Figure 95] for error conditions.

The associated icon will be ON if there is an error condition.

EXAMPLE: Engine Coolant Temperature is High

The Engine Over-Temperature icon (Item 1) [Figure 95] will be ON.

Press the Information button (Item 2) [Figure 95] to cycle the data display until the service code screen is displayed. One of the following SERVICE CODES will be displayed.

- **M0810** Engine Coolant Temperature High
- **M0811** Engine Coolant Temperature Extremely High

Find the cause of the error code and correct before operating the loader again. (See Service Codes List on Page 152.)

Warning And Shutdown

When a WARNING condition exists, the associated icon light will come ON and there will be 3 beeps from the alarm. If this condition is allowed to continue, there may be damage to the engine or loader hydraulic systems.

When a SHUTDOWN condition exists, the associated icon light will come ON and there will be a continuous beep from the alarm. The monitoring system will automatically stop the engine in 15 seconds. The engine can be restarted to move or relocate the loader.

The SHUTDOWN feature is associated with the following icons:

- General Warning**
- Engine Malfunction**
- Engine Coolant Temperature**
- Hydraulic System Malfunction**

STOPPING THE ENGINE AND LEAVING THE LOADER

Procedure

Stop the loader on level ground.

Lower the lift arms fully and put the attachment flat on the ground.

Figure 96



Pull the engine speed control lever (Item 1) [Figure 96] fully backward to decrease the engine speed.

Engage the parking brake.

Figure 97

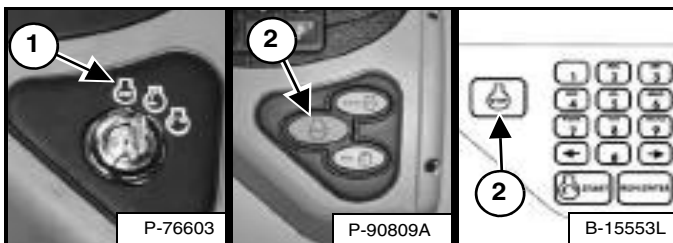

Turn the key switch to the STOP position (Item 1) or press the STOP button (Item 2) [Figure 97].

NOTE: If the loader lights are ON, they will remain ON for approximately 90 seconds after turning the loader OFF.

Move auxiliary control out of detent position.

Raise the seat bar and make sure the lift and tilt functions are deactivated.

Unbuckle the seat belt.

Remove the key from the switch (Standard Key Panel) to prevent operation of the loader by unauthorised personnel.

NOTE: Activating the Password Lockout Feature on machines with the Keyless Start Panel or the Deluxe Instrumentation Panel allows operation of the loader without using a password. (See Password Lockout Feature on Page 159.) or (See Password Lockout Feature on Page 159.)

Figure 98



Exit the loader using grab handles, safety tread and steps (maintaining a 3-point contact) [Figure 98].

WARNING

AVOID INJURY OR DEATH

Before you leave the operator's seat:

- Lower the lift arms and put the attachment flat on the ground.
- Stop the engine.
- Engage the parking brake.
- Raise the seat bar.
- Move all controls to the NEUTRAL / LOCKED position to make sure the lift, tilt and traction drive functions are deactivated.

The seat bar system must deactivate these functions when the seat bar is up. See your Bobcat dealer for service if controls do not deactivate.

W-2463-1110

ATTACHMENTS

Choosing The Correct Bucket



AVOID INJURY OR DEATH

Never use attachments or buckets which are not approved by Bobcat Company. Buckets and attachments for safe loads of specified densities are approved for each model. Unapproved attachments can cause injury or death.

W-2052-0907

NOTE: Warranty is void if non-approved attachments are used on the Bobcat loader.

The dealer can identify, for each model loader, the attachments and buckets approved by Bobcat. The buckets and attachments are approved for Rated Operating Capacity (ROC) and for secure fastening to the Bob-Tach.

The ROC for this loader is shown on a decal in the operator cab. (See Performance on Page 166.)

The ROC is determined by using a bucket and material of normal density, such as dirt or dry gravel. If longer buckets are used, the load centre moves forward and reduces the ROC. If very dense material is loaded, the volume must be reduced to prevent overloading.

Figure 99

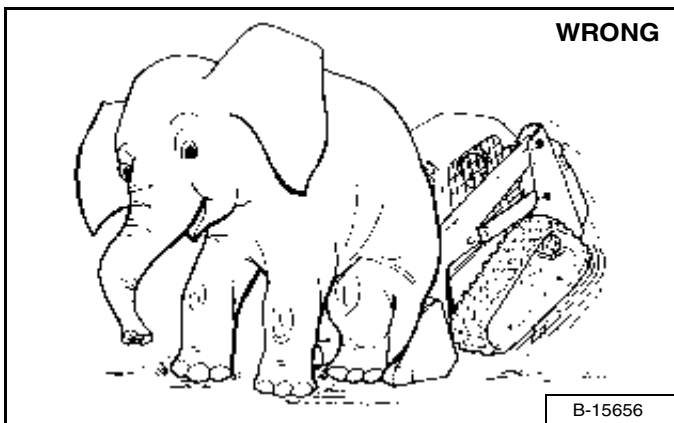

Exceeding the ROC [Figure 99] can cause the following problems:

- Steering the loader may be difficult.
- Tracks will wear faster.
- There will be a loss of stability.
- The life of the Bobcat loader will be reduced.

Use the correct bucket size for the type and density of material being handled. For safe handling of materials and avoiding machine damage, the attachment (or bucket) should handle a full load without going over the ROC for the loader. Partial loads make steering more difficult.

Pallet Forks

Figure 100

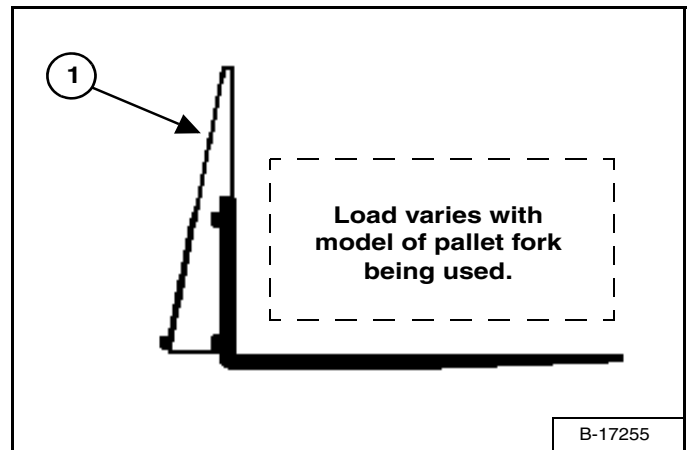

The maximum load to be carried when using a pallet fork is shown on a decal located on the pallet fork frame (Item 1) [Figure 100].

See your Bobcat dealer for more information about pallet fork inspection, maintenance and replacement. See your Bobcat dealer for ROC when using a pallet fork and for other available attachments.



AVOID INJURY OR DEATH

Do not exceed Rated Operating Capacity (ROC). Excessive load can cause tipping or loss of control.

W-2053-0903

ATTACHMENTS (CONT'D)

Installing And Removing The Attachment (Hand Lever Bob-Tach)

The Bob-Tach is used for fast changing of buckets and attachments. See the appropriate attachment Operation & Maintenance Manual to install other attachments.

Figure 101

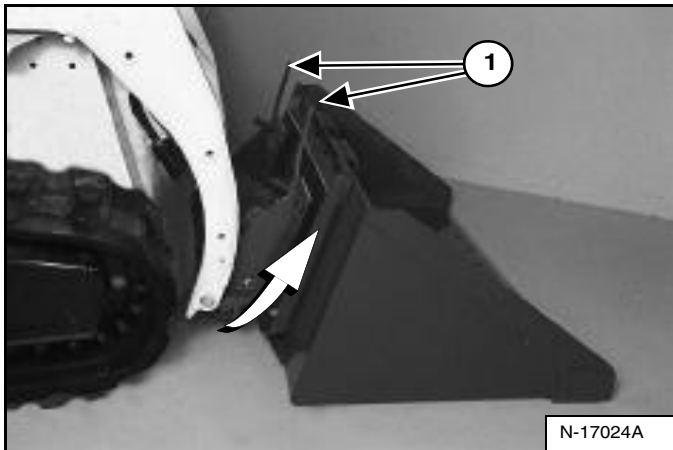

Installing

Pull the Bob-Tach levers all the way up (Item 1) [Figure 101].

Enter the loader and perform the PRE-STARTING PROCEDURE. (See PRE-STARTING PROCEDURE on Page 68.)

Start the engine, press the PRESS TO OPERATE LOADER button and release the parking brake.

Lower the lift arms and tilt the Bob-Tach forward.

Drive the loader forward until the top edge of the Bob-Tach is completely under the top flange of the bucket [Figure 101] (or other attachment). Be sure the Bob-Tach levers do not hit the bucket.

Figure 102

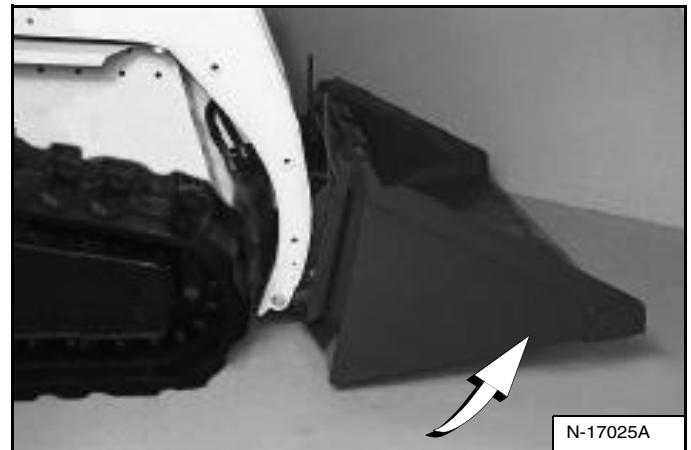

Tilt the Bob-Tach backward until the cutting edge of the bucket (or other attachment) is slightly off the ground to ensure the mounting frame is tight to the Bob-Tach [Figure 102].

Stop the engine and exit the loader. (See STOPPING THE ENGINE AND LEAVING THE LOADER on Page 79.)

WARNING

AVOID INJURY OR DEATH

Before you leave the operator's seat:

- Lower the lift arms and put the attachment flat on the ground.
- Stop the engine.
- Engage the parking brake.
- Raise the seat bar.
- Move all controls to the NEUTRAL / LOCKED position to make sure the lift, tilt and traction drive functions are deactivated.

The seat bar system must deactivate these functions when the seat bar is up. See your Bobcat dealer for service if controls do not deactivate.

W-2463-1110

ATTACHMENTS (CONT'D)

Installing And Removing The Attachment (Hand Lever Bob-Tach) (Cont'd)

Installing (Cont'd)

Figure 103

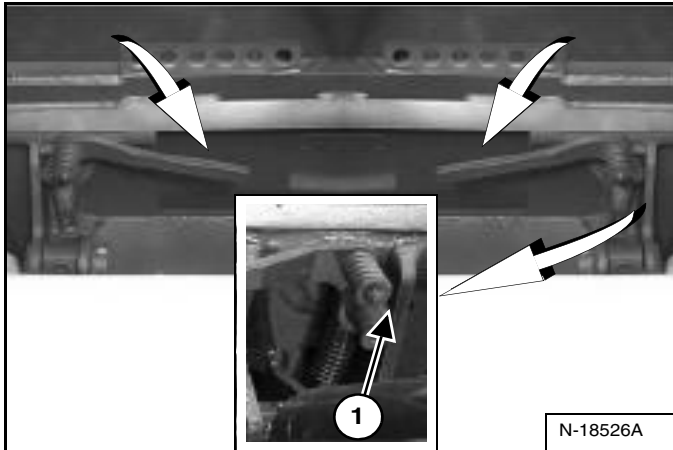

Push down on the Bob-Tach levers until they are fully engaged in the locked position (Item 1) [Figure 103] (wedges fully extended).

Figure 104

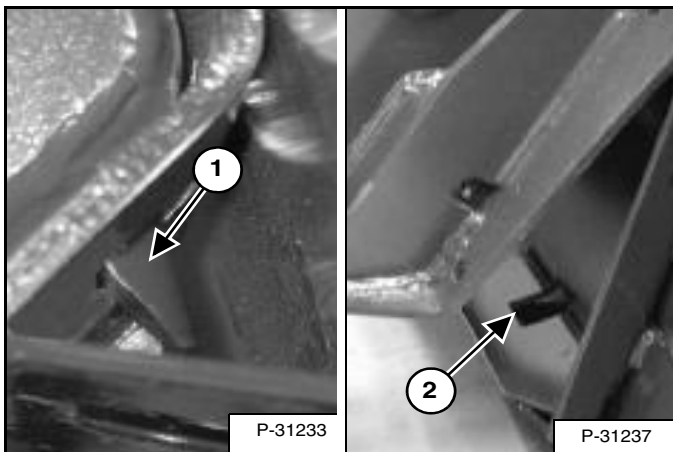

The wedges (Item 1) must extend through the holes (Item 2) [Figure 104] in the mounting frame of the bucket (or other attachment), securely fastening the bucket to the Bob-Tach.

! WARNING

AVOID INJURY OR DEATH

The Bob-Tach wedges must extend through the holes in the attachment mounting frame. Levers must be fully down and locked. Failure to secure wedges can allow attachment to come off.

W-2715-0208

Removing

Lower the lift arms and put the attachment flat on the ground. Lower or close any hydraulic equipment, if applicable.

Stop the engine and exit the loader. (See STOPPING THE ENGINE AND LEAVING THE LOADER on Page 79.)

! WARNING

AVOID INJURY OR DEATH

Before you leave the operator's seat:

- Lower the lift arms and put the attachment flat on the ground.
- Stop the engine.
- Engage the parking brake.
- Raise the seat bar.
- Move all controls to the **NEUTRAL / LOCKED** position to make sure the lift, tilt and traction drive functions are deactivated.

The seat bar system must deactivate these functions when the seat bar is up. See your Bobcat dealer for service if controls do not deactivate.

W-2463-1110

Disconnect attachment electrical harness, water line and hydraulic lines, if applicable, from the loader. (See Relieve Auxiliary Hydraulic Pressure (Loader And Attachment) on Page 64.)

ATTACHMENTS (CONT'D)

Installing And Removing The Attachment (Hand Lever Bob-Tach) (Cont'd)

Removing (Cont'd)

Figure 105



Pull the Bob-Tach levers [Figure 105] all the way up.



Bob-Tach levers have spring tension. Hold lever tightly and release slowly. Failure to obey warning can cause injury.

W-2054-1285

Enter the loader.

Perform the PRE-STARTING PROCEDURE. (See PRE-STARTING PROCEDURE on Page 68.)

Start the engine, press the PRESS TO OPERATE LOADER button and release the parking brake.

Figure 106

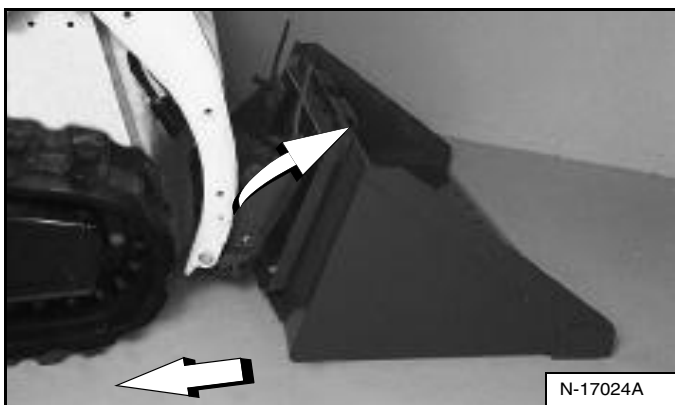

Tilt the Bob-Tach forward and move the loader backward, away from the bucket or attachment [Figure 106].

Installing And Removing The Attachment (Power Bob-Tach)

This machine may be equipped with a Power Bob-Tach.

Installing

The Bob-Tach is used for fast changing of buckets and attachments. See the appropriate attachment Operation & Maintenance Manual to install other attachments.

Perform the PRE-STARTING PROCEDURE. (See PRE-STARTING PROCEDURE on Page 68.)

Start the engine, press the PRESS TO OPERATE LOADER button and release the parking brake.

Lower the lift arms and tilt the Bob-Tach forward.

Figure 107

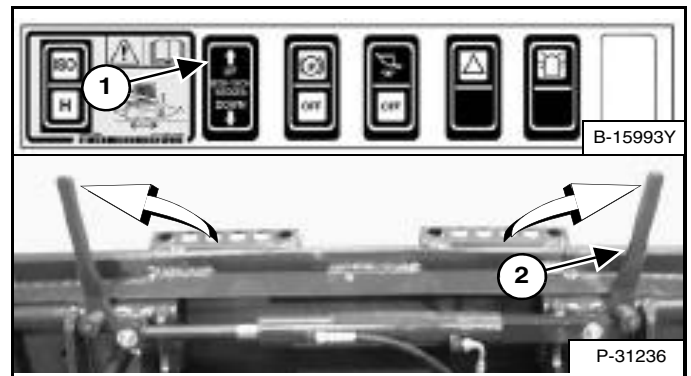

Push and hold BOB-TACH "WEDGES UP" switch (Item 1) (Front Panel) until levers (Item 2) [Figure 107] are in unlocked position (wedges fully raised).

Figure 108

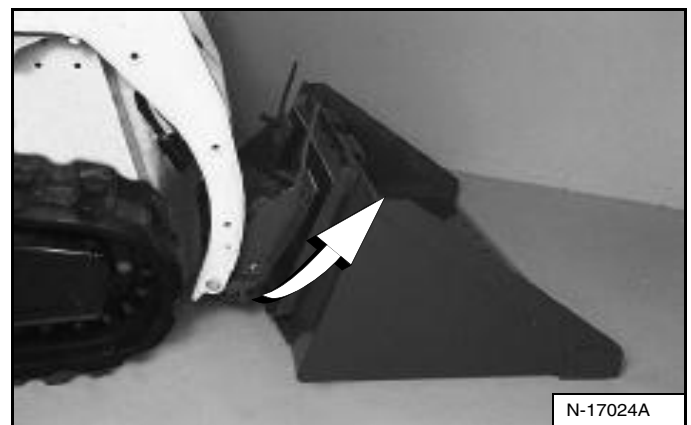

Drive the loader forward until the top edge of the Bob-Tach is completely under the top flange of the bucket [Figure 108] (or other attachment). Be sure the Bob-Tach levers do not hit the bucket.

ATTACHMENTS (CONT'D)

Installing And Removing The Attachment (Power Bob-Tach) (Cont'd)

Installing (Cont'd)

Figure 109

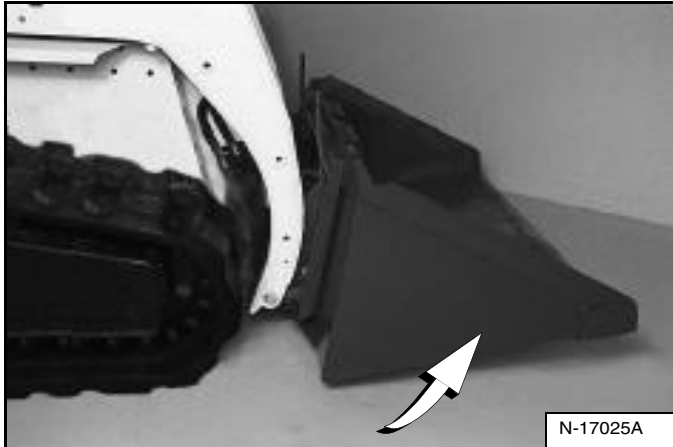

Tilt the Bob-Tach backward until the cutting edge of the bucket (or other attachment) is slightly off the ground [Figure 109].

Push and hold BOB-TACH “WEDGES UP” switch (Item 1) [Figure 107] (Front Panel) to make sure the levers are all the way up.

NOTE: The Power Bob-Tach system has continuous pressurised hydraulic oil to keep the wedges in the engaged position and prevent attachment disengagement. Because the wedges can slowly lower, the operator may need to reactivate the switch (WEDGES UP) to be sure both wedges are fully raised before installing the attachment.

Figure 110

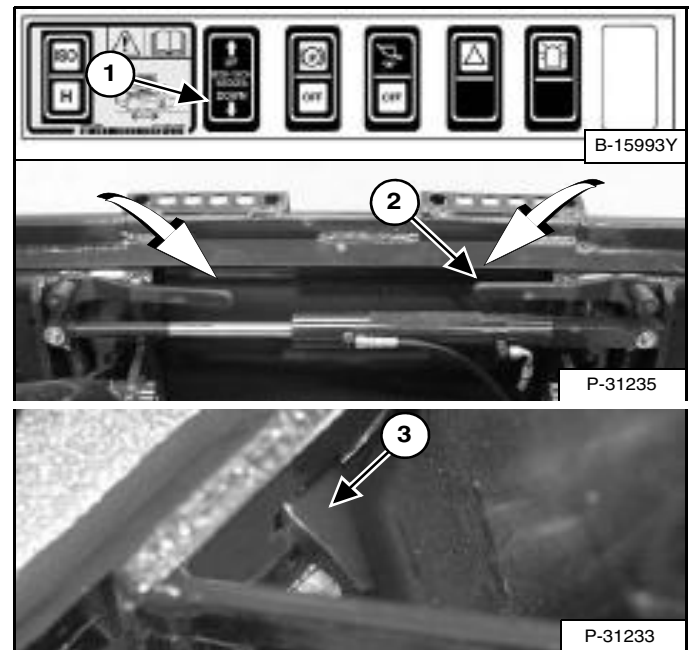

Push and hold BOB-TACH “WEDGES DOWN” switch (Front Panel) (Item 1) until levers are fully engaged in the locked position (Item 2) [Figure 110] (wedges fully engaged).

The wedges (Item 3) [Figure 110] must extend through the holes in the mounting frame of the bucket (or other attachment), securely fastening the bucket to the Bob-Tach.

! WARNING

AVOID INJURY OR DEATH

The Bob-Tach wedges must extend through the holes in the attachment mounting frame. Levers must be fully down and locked. Failure to secure wedges can allow attachment to come off.

W-2715-0208

ATTACHMENTS (CONT'D)

Installing And Removing The Attachment (Power Bob-Tach) (Cont'd)

Removing

Lower the lift arms and put the attachment flat on the ground. Lower or close any hydraulic equipment, if applicable.

If the attachment has electrical, water or hydraulic connections to the loader:

1. Stop the engine and exit the loader. (See STOPPING THE ENGINE AND LEAVING THE LOADER on Page 79.)

WARNING

AVOID INJURY OR DEATH

Before you leave the operator's seat:

- Lower the lift arms and put the attachment flat on the ground.
- Stop the engine.
- Engage the parking brake.
- Raise the seat bar.
- Move all controls to the **NEUTRAL / LOCKED** position to make sure the lift, tilt and traction drive functions are deactivated.

The seat bar system must deactivate these functions when the seat bar is up. See your Bobcat dealer for service if controls do not deactivate.

W-2463-1110

2. Disconnect attachment electrical harness and water or hydraulic lines, if applicable, from the loader. (See Relieve Auxiliary Hydraulic Pressure (Loader And Attachment) on Page 64.)
3. Perform the PRE-STARTING PROCEDURE. (See PRE-STARTING PROCEDURE on Page 68.)
4. Start the engine, press the PRESS TO OPERATE LOADER button and release the parking brake.

Figure 111

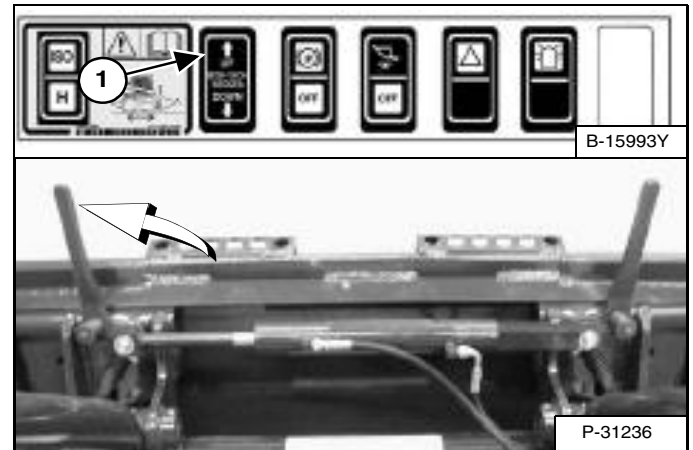

Push and hold the BOB-TACH “WEDGES UP” switch (Front Panel) (Item 1) [Figure 111] until the wedges are fully raised.

Figure 112

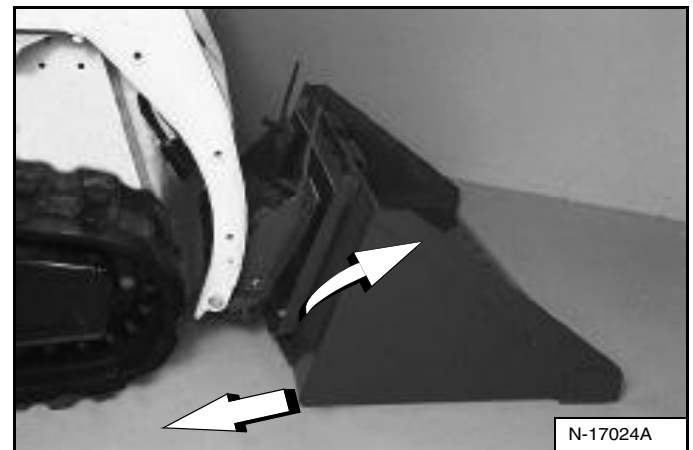

Tilt the Bob-Tach forward and move the loader backward, away from the bucket or attachment [Figure 112].

NOTE: The Power Bob-Tach system has continuous pressurised hydraulic oil to keep the wedges in the engaged position and prevent attachment disengagement. Because the wedges can slowly lower, the operator may need to reactivate the switch (WEDGES UP) when removing an attachment to be sure both wedges are fully raised.

TRACK UNDERCARRIAGE SYSTEM

Introduction

There are many advantages of a Bobcat Compact Track Loader. They provide very high flotation, low ground pressure, turf friendly rubber tracks and excellent traction.

Compact Track Loader Operating And Maintenance Tips

Track Tension: Correct track tension is important. If the tracks are too loose, they can easily derail. If they are too tight, they will wear faster and cause increased stress on the complete track carriage system. (See TRACK TENSION on Page 137.)

Figure 113

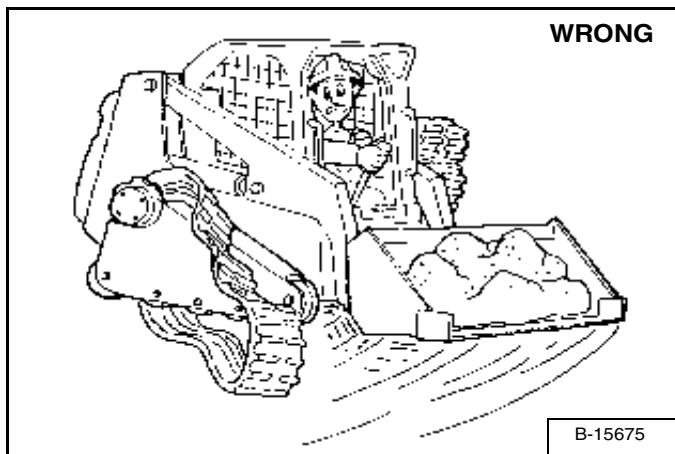

Turning: Use a gradual turn (one lever farther forward than the other) instead of a fast turn (one lever forward and one lever backward) on asphalt or concrete surfaces to prevent reduced track life or derailing of tracks [Figure 113].

Always carry the load low.

Figure 114

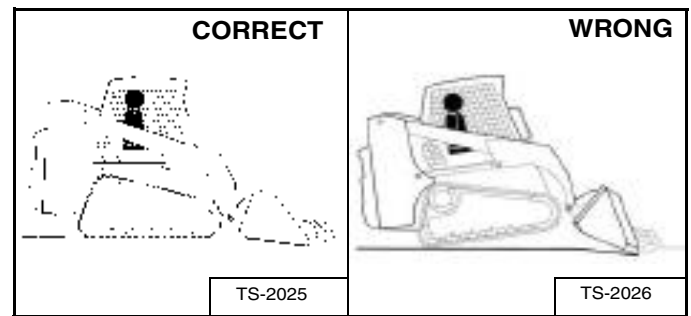

Digging And Leveling: Keep the full length of the tracks in contact with the ground [Figure 114] for best traction. Raising the front end of the tracks off the ground [Figure 114] will reduce traction and cause increased track wear.

Operating On Slopes: Go directly up or down a slope, not across the slope to prevent tracks from derailing.

Figure 115

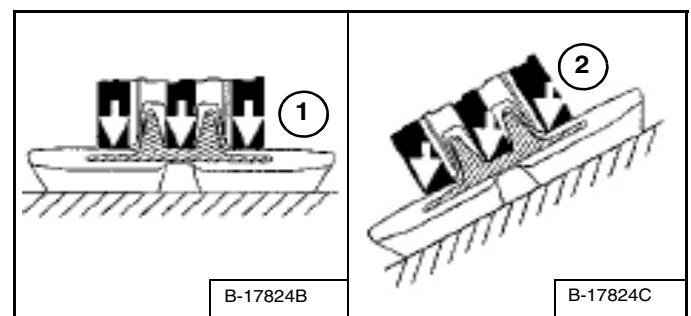

The track carriage components will wear faster when operated on a slope. When the machine is operated on a level surface, the weight of the machine is distributed throughout the entire surface of the rollers to the tracks (Item 1) [Figure 115]. When operated on a slope, the weight is directed to the edge of the rollers and against the lugs of the track (Item 2) [Figure 115] which causes increased wear.

TRACK UNDERCARRIAGE SYSTEM (CONT'D)

Compact Track Loader Operating And Maintenance Tips (Cont'd)

Figure 116

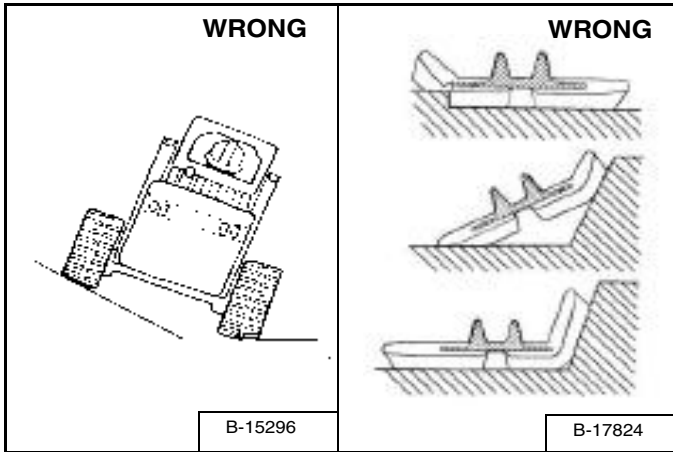

Operating Conditions: Avoid operating the loader with one track on a slope and the other on flat ground [Figure 116] or with the end of the track turned up against a curb or mound [Figure 116]. This can cause the tracks to derail, cracks in the edge of the tracks or cracks at the edges of the embedded metal.

Figure 117

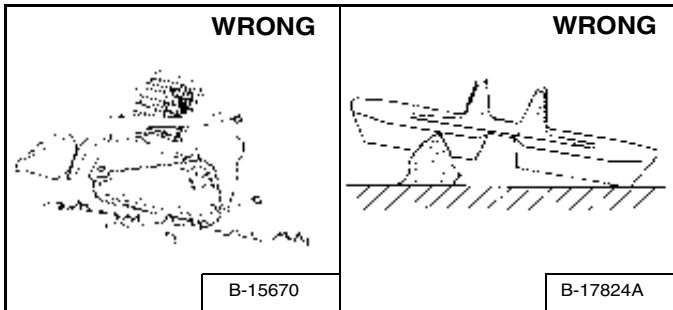

Avoid operating or turning on sharp objects such as jagged rocks, broken concrete, quarry materials or scrap applications. This can cause cuts on the lug surface of the tracks [Figure 117].

Cleaning And Maintenance: Keep the track carriage system as clean as possible. Remove rocks and debris from the tracks and rollers. Use a pressure washer if necessary.

Rotating: The tracks and sprockets should be periodically rotated to the opposite side of the machine. It is important to rotate the tracks and sprockets as a set for maximum service life. See your Bobcat dealer for track and sprocket rotation.

It's All About The Tracks:

- Follow operating and maintenance tips.
- Keep rollers and idlers clean.
- Know what conditions can cause accelerated wear.
- Watch for abnormal wear patterns.
- Replace components and tracks as needed.



OPERATING PROCEDURE

Inspect The Work Area

Before beginning operation, inspect the work area for unsafe conditions.

Look for sharp drop-offs or rough terrain. Have underground utility lines (gas, electrical, water, sewer, irrigation, etc.) located and marked.

Remove objects or other construction material that could damage the loader or cause personal injury.

Always check ground conditions before starting your work:

- Inspect for signs of instability such as cracks or settlement.
- Be aware of weather conditions that can affect ground stability.
- Check for adequate traction if working on a slope.

Basic Operating Instructions

Always warm the engine and hydrostatic system before operating the loader.

IMPORTANT

Machines warmed up with moderate engine speed and light load have longer life.

I-2015-0284

Operate the loader with engine at full speed for maximum horsepower. Move the steering levers only a small amount to operate the loader slowly.

New operators must operate the loader in an open area without bystanders. Operate the controls until the loader can be handled at an efficient and safe rate for all conditions of the work area.

Operating Near An Edge Or Water

Keep the loader as far back from the edge as possible and the loader tracks perpendicular to the edge so that if part of the edge collapses, the loader can be moved back.

Always move the loader back at any indication the edge may be unstable.

WARNING

MACHINE TIPPING OR ROLL OVER CAN CAUSE SERIOUS INJURY OR DEATH

- **Keep the lift arms as low as possible.**
- **Do not travel or turn with the lift arms up.**
- **Turn on level ground. Slow down when turning.**
- **Go up and down slopes, not across them.**
- **Keep the heavy end of the machine uphill.**
- **Do not overload the machine.**
- **Check for adequate traction.**

W-2018-1109

Driving On Public Roads

When operating on a public road or motorway, always follow local regulations. For example: Slow Moving Vehicle Sign or direction signals may be required.

NOTE: Road Option kits are available from your Bobcat dealer to equip your machine for driving on public roads in European Union (EU) countries.

Always follow local regulations. For more information, contact your local Bobcat dealer.

OPERATING PROCEDURE (CONT'D)

Operating With A Full Bucket

Figure 118

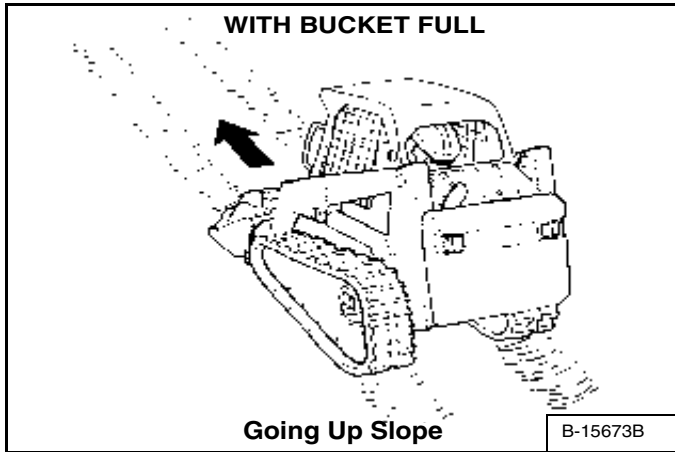
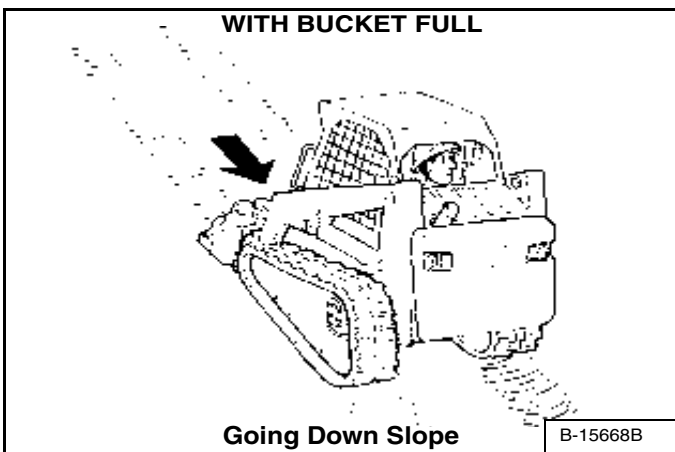

Figure 119



With a full bucket, go up or down the slope with the heavy end toward the top of the slope [Figure 118] and [Figure 119].

Operating With An Empty Bucket

Figure 120

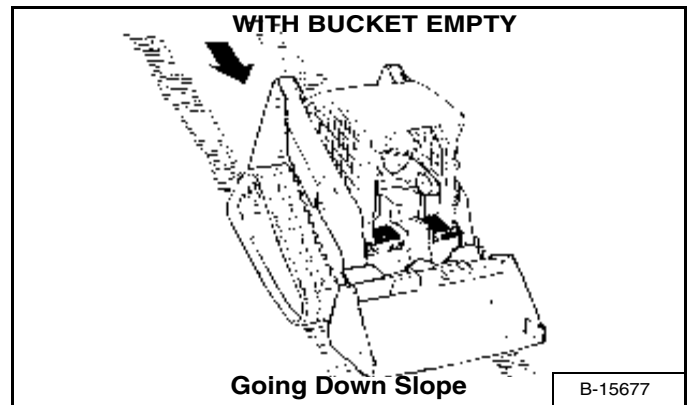
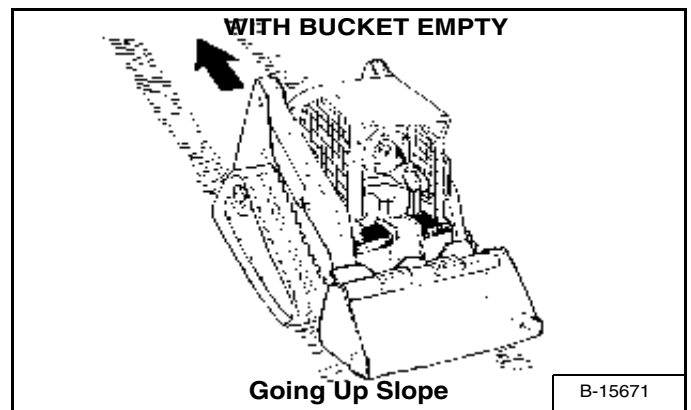

Figure 121



With an empty bucket, go down or up the slope with the heavy end toward the top of the slope [Figure 120] and [Figure 121].

Raise the bucket only high enough to avoid obstructions on rough ground.

OPERATING PROCEDURE (CONT'D)

Filling And Emptying The Bucket (Foot Pedals)

Filling

Figure 122

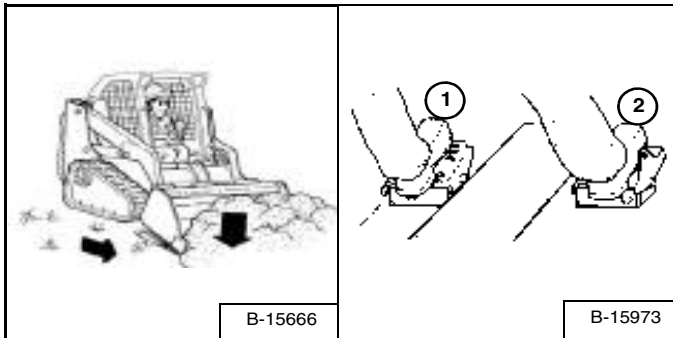
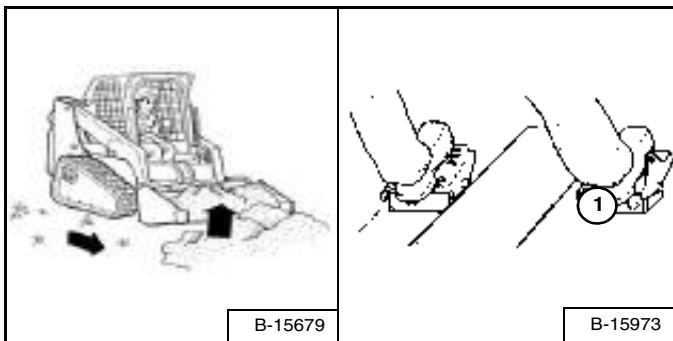

Figure 123



Lower the lift arms all the way (Item 1) [Figure 122].

Tilt the bucket forward (Item 2) [Figure 122] until the cutting edge of the bucket is on the ground.

Drive slowly forward into the material. Tilt the bucket backward (Item 1) [Figure 123] all the way when the bucket is full.

Drive backward away from the material.



Load, unload and turn on flat level ground. Do not exceed Rated Operating Capacity (ROC) shown on sign (decal) in cab. Failure to obey warnings can cause the machine to tip or roll over and cause injury or death.

W-2056-0903

Emptying

Figure 124

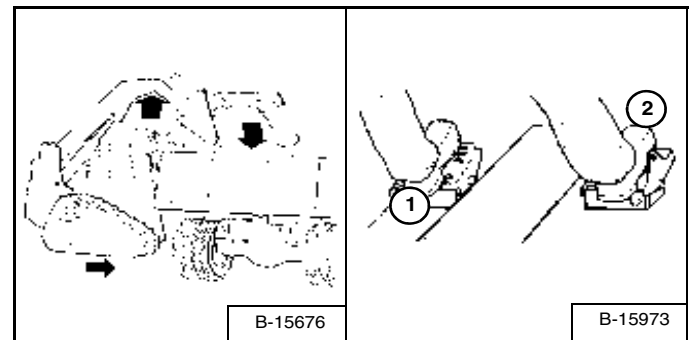

Keep the bucket low when moving to the area where you want to empty the bucket.

Level the bucket by pushing the toe of the right pedal (Item 2) while raising the lift arms (or use the BUCKET POSITIONING button if equipped) to help prevent material from falling off the back of the bucket. Raise the lift arms by pushing the heel of the left pedal (Item 1) [Figure 124].

Drive forward slowly until the bucket is over the top of the truck box or bin [Figure 124].

Empty the bucket by pushing the toe of the right pedal (Item 2) [Figure 124]. If all the material is near the side of the truck or bin, use the bucket tilt to move it to the other side.



Never dump over an obstruction, such as a post, that can enter the operator cab. The machine could tip forward and cause injury or death.

W-2057-0694

OPERATING PROCEDURE (CONT'D)

Leveling The Ground Using Float (Foot Pedals)

Figure 125

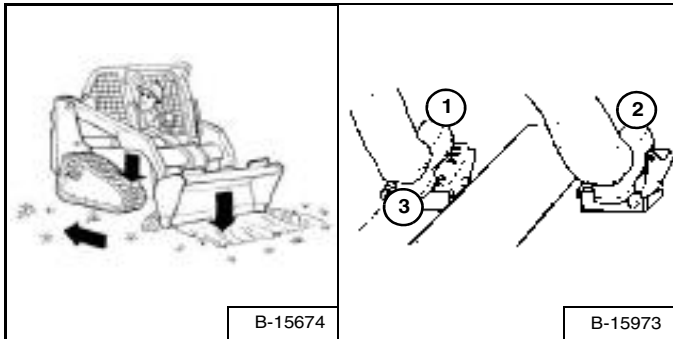

Put the lift arms in *float* position by pushing the toe of the left pedal (Item 1) [Figure 125] until it is locked in the forward position.

Tilt the bucket forward by pushing the toe of the right pedal (Item 2) [Figure 125] to change the position of the cutting edge of the bucket.

With the bucket tilted farther forward, there is more force on the cutting edge and more loose material can be moved.

Drive backward to level loose material [Figure 125].

Push the heel of the left pedal (Item 3) [Figure 125] to unlock the float position.

IMPORTANT

Never drive forward when the hydraulic control for lift arms is in float position.

I-2005-1285

Digging And Filling A Hole (Foot Pedals)

Digging

Figure 126

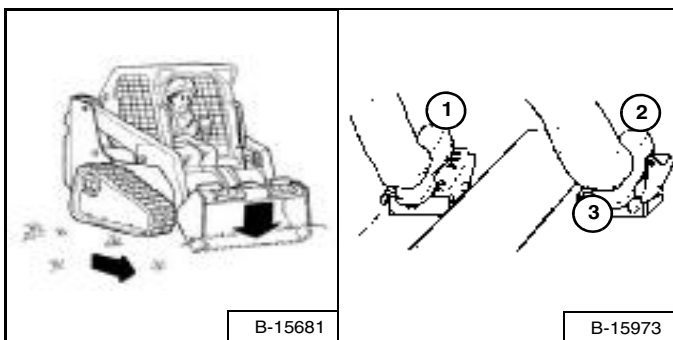

Lower the lift arms all the way by pushing the toe of the left pedal (Item 1). Put the cutting edge of the bucket on the ground by pushing the toe of the right pedal (Item 2) [Figure 126].

Drive forward slowly and continue to tilt the bucket down (Item 2) [Figure 126] until it enters the ground.

Raise the cutting edge a small amount by pushing the heel of the right pedal (Item 3) to increase traction and keep an even digging depth. Continue to drive forward until the bucket is full. When the ground is hard, raise and lower the cutting edge of the bucket (Items 2 and 3) [Figure 126] while driving forward slowly.

Figure 127

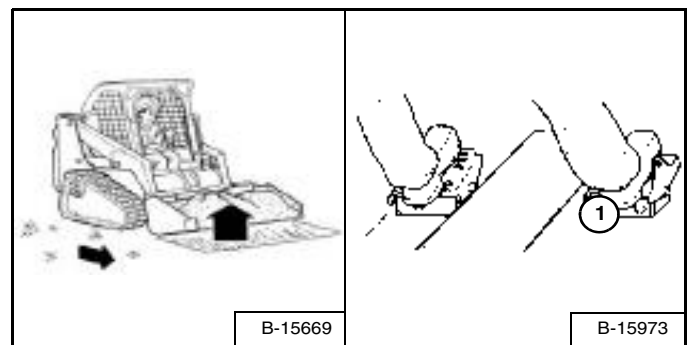

Tilt the bucket backward by pushing the heel of the right pedal (Item 1) [Figure 127] as far as it will go when the bucket is full.

Filling

Figure 128

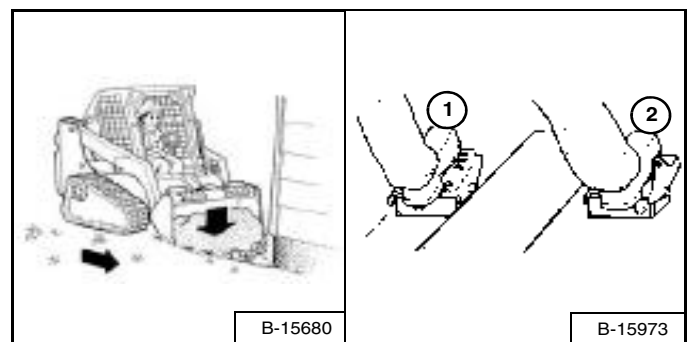

Lower the lift arms by pushing the toe of the left pedal (Item 1). Put the cutting edge of the bucket on the ground by pushing the toe of the right pedal (Item 2) [Figure 128]. Drive forward to the edge of the hole to push the material into the hole.

Tilt the bucket farther forward (Item 2) [Figure 128] as soon as it is past the edge of the hole.

If necessary, raise the lift arms to empty the bucket.

OPERATING PROCEDURE (CONT'D)

Filling And Emptying The Bucket (SJC - 'H' Pattern)

Filling

Figure 129

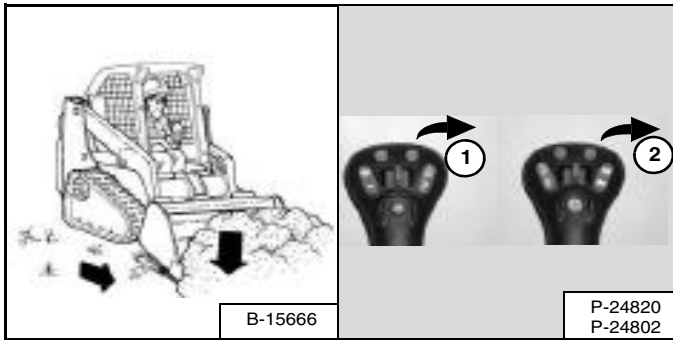
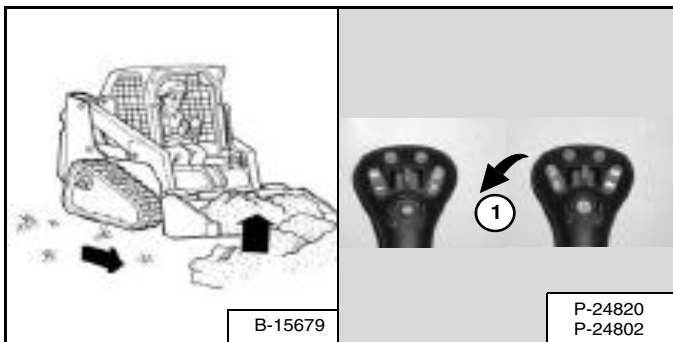

Figure 130



Lower the lift arms all the way (Item 1) [Figure 129].

Tilt the bucket forward (Item 2) [Figure 129] until the cutting edge of the bucket is on the ground.

Drive slowly forward into the material. Tilt the bucket backward (Item 1) [Figure 130] all the way when the bucket is full.

Drive backward away from the material.



Load, unload and turn on flat level ground. Do not exceed Rated Operating Capacity (ROC) shown on sign (decal) in cab. Failure to obey warnings can cause the machine to tip or roll over and cause injury or death.

W-2056-0903

Emptying

Figure 131

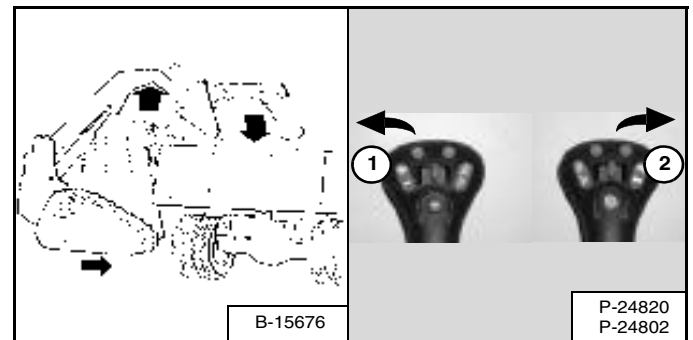

Keep the bucket low when moving to the area where you want to empty the bucket.

Raise the lift arms (Item 1) [Figure 131]. Level the bucket (Item 2) [Figure 131] while raising the lift arms to help prevent material from falling off the back of the bucket.

Drive forward slowly until the bucket is over the top of the truck box or bin.

Empty the bucket (Item 2) [Figure 131]. If all material is near the side of the truck or bin, use the bucket tilt to move it to the other side.



Never dump over an obstruction, such as a post, that can enter the operator cab. The machine could tip forward and cause injury or death.

W-2057-0694

OPERATING PROCEDURE (CONT'D)

Leveling The Ground Using Float (SJC - 'H' Pattern)

Figure 132

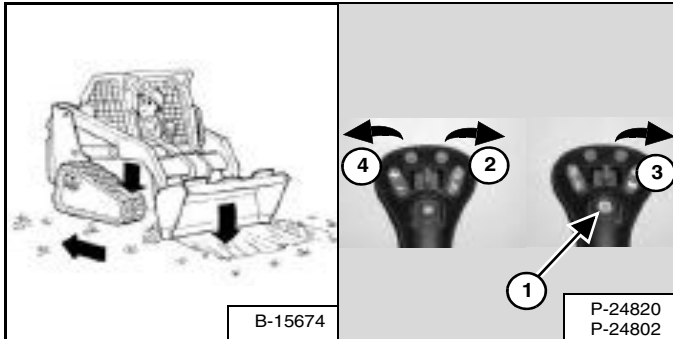

Press and hold the float button (Item 1) [Figure 132] while the joystick is in neutral. While lowering the lift arms (Item 2) [Figure 132], release the float button.

Tilt the bucket forward (Item 3) [Figure 132] to change the position of the cutting edge of the bucket.

With the bucket tilted farther forward, there is more force on the cutting edge and more loose material can be moved.

Drive backward to level loose material.

To disengage, press the float button again or raise the lift arms (Item 4) [Figure 132].

IMPORTANT

Never drive forward when the hydraulic control for lift arms is in float position.

I-2005-1285

OPERATING PROCEDURE (CONT'D)

Digging And Filling A Hole (SJC - 'H' Pattern)

Digging

Figure 133

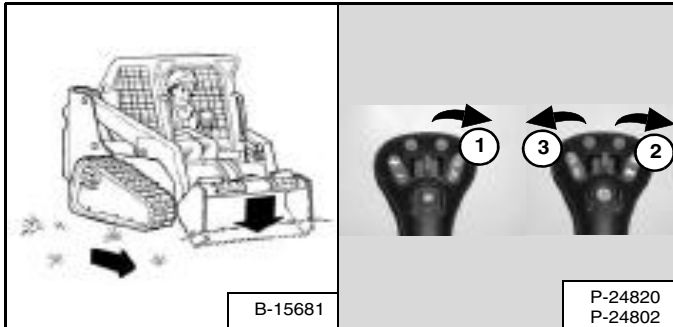

Lower the lift arms all the way (Item 1) [Figure 133]. Put the cutting edge of the bucket on the ground (Item 2) [Figure 133].

Drive forward slowly and continue to tilt the bucket down (Item 2) [Figure 133] until it enters the ground.

Raise the cutting edge a small amount (Item 3) [Figure 133] to increase traction and keep an even digging depth. Continue to drive forward until the bucket is full. When the ground is hard, raise and lower the cutting edge (Items 2 and 3) [Figure 133] while driving forward.

Tilt the bucket backward (Item 3) [Figure 133] as far as it will go when the bucket is full.

Filling

Figure 134

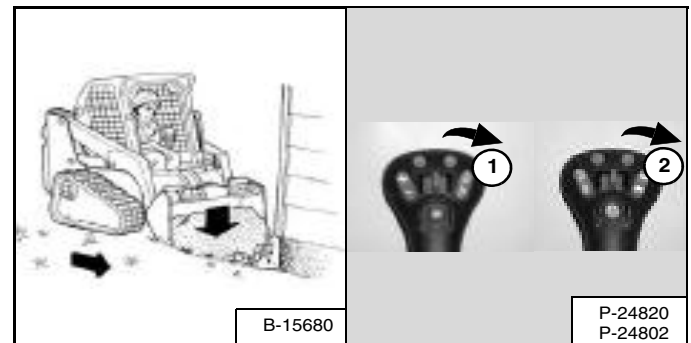

Lower the lift arms (Item 1) [Figure 134] and put the cutting edge of the bucket on the ground (Item 2) [Figure 134]. Drive forward to the edge of the hole to push the material into the hole.

Tilt the bucket forward (Item 2) [Figure 134] as soon as it is past the edge of the hole.

If necessary, raise the lift arms to empty the bucket.

OPERATING PROCEDURE (CONT'D)

Filling And Emptying The Bucket (SJC - 'ISO' Pattern)

Filling

Figure 135

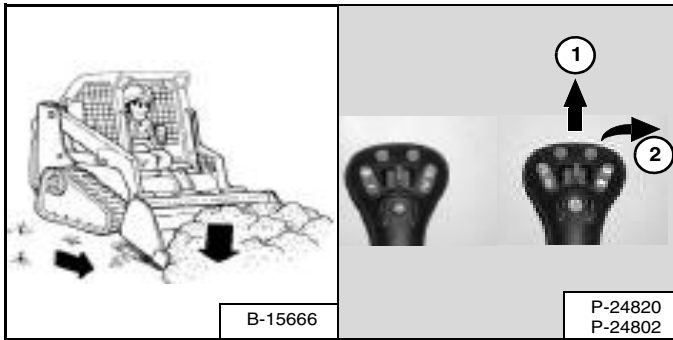
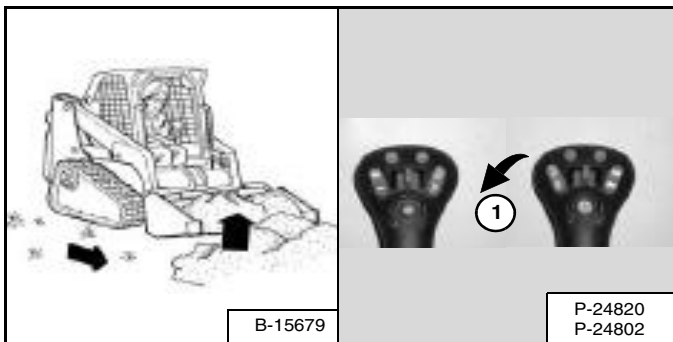

Figure 136



Lower the lift arms all the way (Item 1) [Figure 135].

Tilt the bucket forward (Item 2) [Figure 135] until the cutting edge of the bucket is on the ground.

Drive slowly forward into the material. Tilt the bucket backward (Item 1) [Figure 136] all the way when the bucket is full.

Drive backward away from the material.



Load, unload and turn on flat level ground. Do not exceed Rated Operating Capacity (ROC) shown on sign (decal) in cab. Failure to obey warnings can cause the machine to tip or roll over and cause injury or death.

W-2056-0903

Emptying

Figure 137

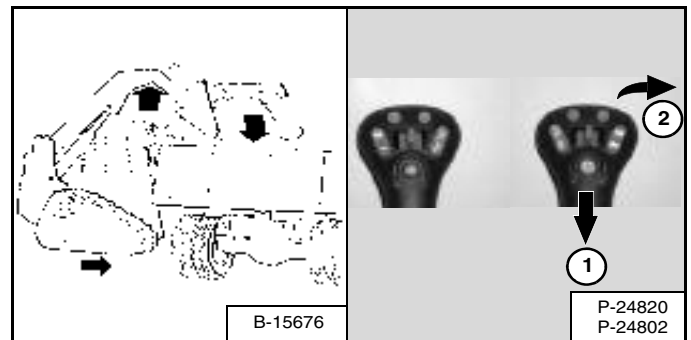

Keep the bucket low when moving to the area where you want to empty the bucket.

Raise the lift arms (Item 1) [Figure 137]. Level the bucket (Item 2) [Figure 137] while raising the lift arms to help prevent material from falling off the back of the bucket.

Drive forward slowly until the bucket is over the top of the truck box or bin.

Empty the bucket (Item 2) [Figure 137]. If all material is near the side of the truck or bin, use the bucket tilt to move it to the other side.



Never dump over an obstruction, such as a post, that can enter the operator cab. The machine could tip forward and cause injury or death.

W-2057-0694

OPERATING PROCEDURE (CONT'D)

Leveling The Ground Using Float (SJC - 'ISO' Pattern)

Figure 138

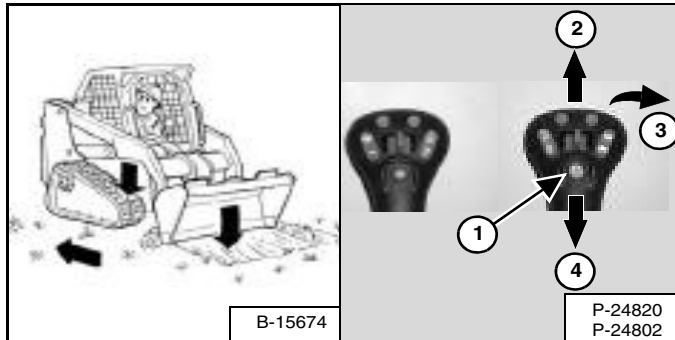

Press and hold the float button (Item 1) [Figure 138] while the joystick is in neutral. While lowering the lift arms (Item 2) [Figure 138], release the float button.

Tilt the bucket forward (Item 3) [Figure 138] to change the position of the cutting edge of the bucket.

With the bucket tilted farther forward, there is more force on the cutting edge and more loose material can be moved.

Drive backward to level loose material.

To disengage, press the float button again or raise the lift arms (Item 4) [Figure 138].

IMPORTANT

Never drive forward when the hydraulic control for lift arms is in float position.

I-2005-1285

Digging And Filling A Hole (SJC - 'ISO' Pattern)

Digging

Figure 139

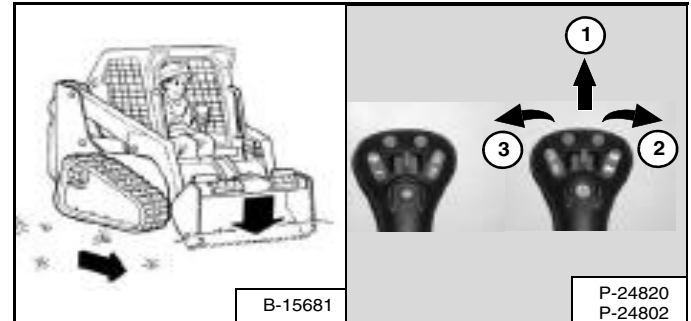

Lower the lift arms all the way (Item 1) [Figure 139]. Put the cutting edge of the bucket on the ground (Item 2) [Figure 139].

Drive forward slowly and continue to tilt the bucket down (Item 2) [Figure 139] until it enters the ground.

Raise the cutting edge a small amount (Item 3) [Figure 139] to increase traction and keep an even digging depth. Continue to drive forward until the bucket is full. When the ground is hard, raise and lower the cutting edge (Items 2 and 3) [Figure 139] while driving forward.

Tilt the bucket backward (Item 3) [Figure 139] as far as it will go when the bucket is full.

Filling

Figure 140

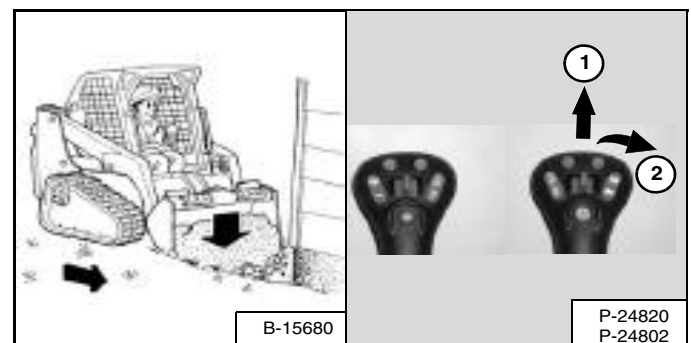

Lower the lift arms (Item 1) [Figure 140] and put the cutting edge of the bucket on the ground (Item 2) [Figure 140]. Drive forward to the edge of the hole to push the material into the hole.

Tilt the bucket forward (Item 2) [Figure 140] as soon as it is past the edge of the hole.

If necessary, raise the lift arms to empty the bucket.

TOWING THE LOADER

Procedure

Because of the design of the loader, there is not a recommended towing procedure.

- The loader can be lifted onto a transport vehicle.
- The loader can be skidded a short distance to move for service (EXAMPLE: Move onto a transport vehicle.) without damage to the hydrostatic system. (The tracks will not turn.) There might be slight wear to the tracks when the loader is skidded.

The towing chain (or cable) must be rated at 1.5 times the weight of the loader. (See Performance on Page 166.)

LIFTING THE LOADER

Single-Point Lift

! WARNING

AVOID INJURY OR DEATH

- Before lifting, check fasteners on single point lift and operator cab.
- Assemble front cab fasteners as shown in this manual.
- Never allow riders in the cab or bystanders within 5 m (15 ft) while lifting the machine.

W-2007-0910

The loader can be lifted with the Single-Point Lift which is available as a kit from your Bobcat loader dealer.

The Single-Point Lift, supplied by Bobcat, is designed to lift and support the Bobcat loader without affecting roll over and falling object protection features of the operator cab.

Figure 141

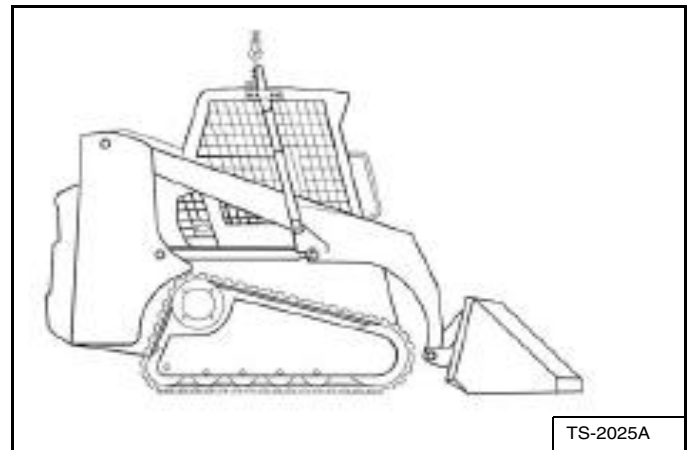

TS-2025A

Attach lift to lift eye [Figure 141].

NOTE: Be sure the lifting equipment is of adequate size and capacity for the weight of the loader. (See Performance on Page 166.)

TRANSPORTING THE LOADER ON A TRAILER

Loading And Unloading

! WARNING

AVOID SERIOUS INJURY OR DEATH

Adequately designed ramps of sufficient strength are needed to support the weight of the machine when loading onto a transport vehicle. Wood ramps can break and cause personal injury.

W-2058-0807

Be sure the transport and towing vehicles are of adequate size and capacity for weight of loader. (See Performance on Page 166.)

Figure 142

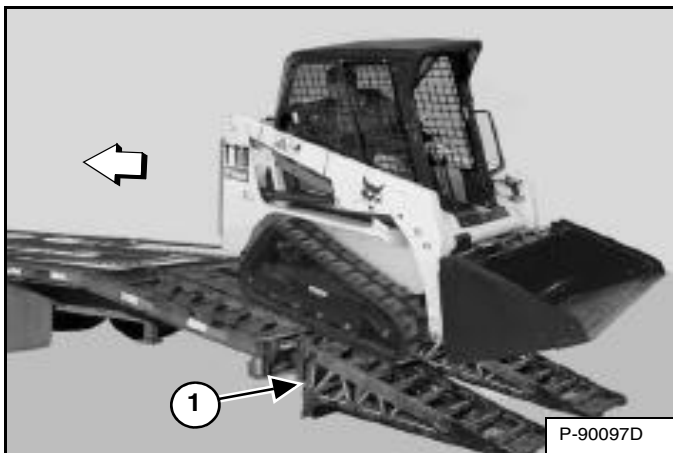

A loader with an empty bucket or no attachment must be loaded backward onto the transport vehicle [Figure 142].

The rear of the trailer must be blocked or supported (Item 1) [Figure 142] when loading or unloading the loader to prevent the front end of the trailer from raising up.

Fastening

Figure 143

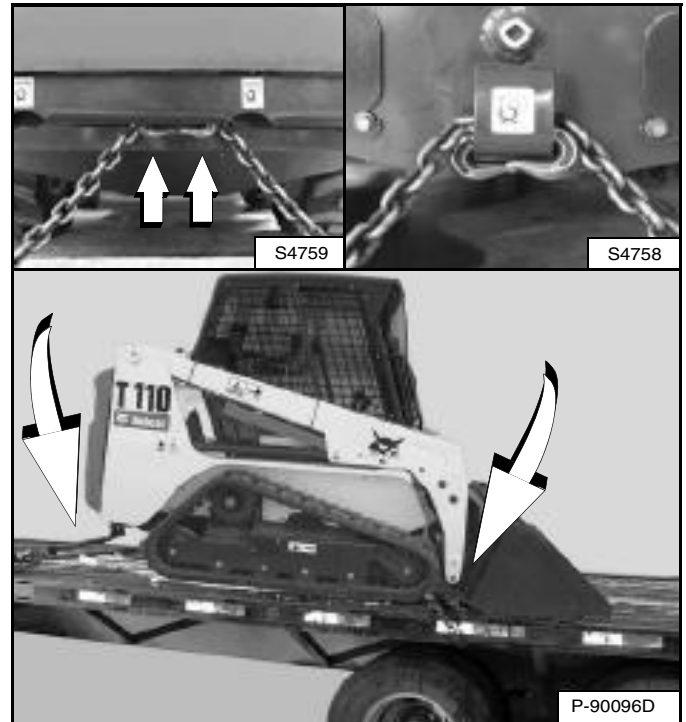

Use the following procedure to fasten the Bobcat loader to the transport vehicle to prevent the loader from moving during sudden stops or when going up or down slopes [Figure 143].

1. Lower the bucket or attachment to the floor.
2. Stop the engine.
3. Engage the parking brake.
4. Install chains at the front and rear loader tie down positions [Figure 143].
5. Fasten each end of the chain to the transport vehicle.



PREVENTIVE MAINTENANCE

MAINTENANCE SAFETY	103
SERVICE SCHEDULE	105
Chart	105
Inspection Checkbook	106
BOBCAT INTERLOCK CONTROL SYSTEM (BICS™)	106
Inspecting The BICS™ (Engine STOPPED - Key ON)	106
Inspecting Deactivation Of The Auxiliary Hydraulics System (Engine STOPPED - Key ON)	106
Inspecting The Seat Bar Sensor (Engine RUNNING)	107
Inspecting The Traction Lock (Engine RUNNING)	107
Inspecting The Lift Arm Bypass Control	107
Inspecting Deactivation Of Lift And Tilt Functions (SJC)	107
Inspecting Deactivation Of The Auxiliary Hydraulics System (Engine RUNNING)	108
SEAT BAR RESTRAINT SYSTEM	109
Description	109
Inspecting	109
Maintaining	109
SEAT BELT	110
Inspection And Maintenance	110
LIFT ARM SUPPORT DEVICE	111
Installing	111
Removing	112
BACK-UP ALARM SYSTEM	113
Description	113
Inspecting	113
Adjusting Switch Position	113
OPERATOR CAB	114
Description	114
Raising	114
Lowering	115
Cab Door Sensor	116
REAR DOOR (TAILGATE)	117
Opening And Closing	117
Adjusting	117
REAR GRILLE	117
Removing	117
Installing	117



HEATING SYSTEM	118
Cleaning And Maintenance	118
Filters	118
Heater Coil	118
Troubleshooting	118
AIR CLEANER SERVICE	119
Replacing Filter Elements	119
FUEL SYSTEM	121
Fuel Specifications	121
Biodiesel Blend Fuel	121
Filling The Fuel Tank	122
Fuel Filter	123
Removing Air From The Fuel System	123
ENGINE LUBRICATION SYSTEM	124
Checking And Adding Engine Oil	124
Engine Oil Chart	124
Removing And Replacing Oil And Filter	125
ENGINE COOLING SYSTEM	126
Cleaning	126
Checking Level	126
Removing And Replacing Coolant	127
ELECTRICAL SYSTEM	128
Description	128
Fuse And Relay Location / Identification	128
Battery Maintenance	129
Using A Booster Battery (Jump Starting)	130
Removing And Installing Battery	131
HYDRAULIC / HYDROSTATIC SYSTEM	132
Checking And Adding Fluid	132
Hydraulic / Hydrostatic Fluid Chart	132
Removing And Replacing Hydraulic Fluid	133
Removing And Replacing Hydraulic / Hydrostatic Filter	134
Removing And Replacing Case Drain Filters	134
Removing And Replacing Hydraulic Charge Filter	135
Breather Cap	135
SPARK ARRESTER MUFFLER	136
Cleaning Procedure	136
TRACK TENSION	137
Description	137
Checking	137
Adjusting	138
HYDROSTATIC DRIVE MOTOR	139
Removing And Replacing Oil	139



TRACK SPROCKET MAINTENANCE	139
Tightening Procedure	139
ALTERNATOR BELT	140
Belt Adjustment	140
Belt Replacement	140
DRIVE BELT	141
Belt Adjustment	141
Belt Replacement	141
LUBRICATING THE LOADER	142
Lubrication Locations	142
TRACK ROLLER AND IDLER LUBRICATION	143
Procedure	143
PIVOT PINS	144
Inspection And Maintenance	144
BOB-TACH (HAND LEVER)	145
Inspection And Maintenance	145
BOB-TACH (POWER)	146
Inspection And Maintenance	146
LOADER STORAGE AND RETURN TO SERVICE	147
Storage	147
Return To Service	147



Bobcat®



MAINTENANCE SAFETY



WARNING

Instructions are necessary before operating or servicing machine. Read and understand the Operation & Maintenance Manual, Operator's Handbook and signs (decals) on machine. Follow warnings and instructions in the manuals when making repairs, adjustments or servicing. Check for correct function after adjustments, repairs or service. Untrained operators and failure to follow instructions can cause injury or death.

W-2003-0807



Safety Alert Symbol: This symbol with a warning statement, means: "Warning, be alert! Your safety is involved!" Carefully read the message that follows.

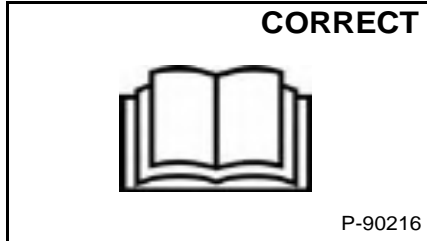

P-90216

- ⚠ Never service the Bobcat Compact Track Loader without instructions.

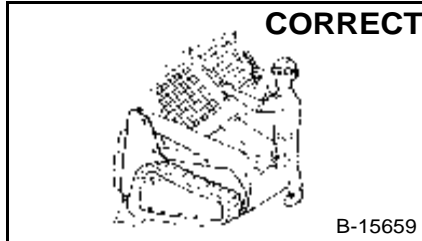

B-15659

- ⚠ Use the correct procedure to lift or lower operator cab.

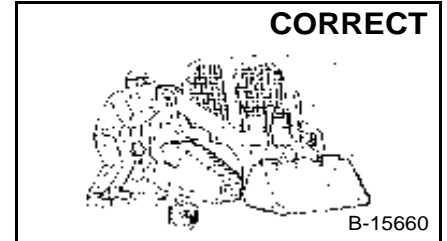

B-15660

- ⚠ Cleaning and maintenance are required daily.



B-15664

- ⚠ Have good ventilation when welding or grinding painted parts.
- ⚠ Wear dust mask when grinding painted parts. Toxic dust and gas can be produced.
- ⚠ Avoid exhaust fume leaks which can kill without warning. Exhaust system must be tightly sealed.



B-15661

- ⚠ Disconnecting or loosening any hydraulic tubeline, hose, fitting, component or a part failure can cause lift arms to drop. Do not go under lift arms when raised unless supported by an approved lift arm support device. Replace it if damaged.

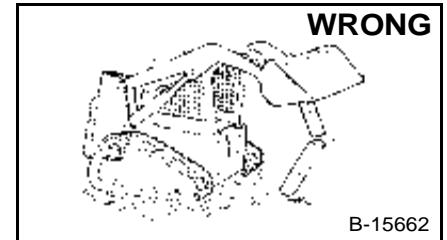

B-15662

- ⚠ Never work on loader with lift arms up unless lift arms are held by an approved lift arm support device. Replace if damaged.
- ⚠ Never modify equipment or add attachments not approved by Bobcat Company.



B-15665

- ⚠ Stop, cool and clean engine of flammable materials before checking fluids.
- ⚠ Never service or adjust loader with the engine running unless instructed to do so in the manual.
- ⚠ Avoid contact with leaking hydraulic fluid or diesel fuel under pressure. It can penetrate the skin or eyes.
- ⚠ Never fill fuel tank with engine running, while smoking or when near open flame.

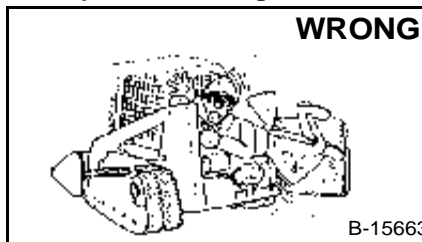

B-15663

- ⚠ Keep body, jewelry and clothing away from moving parts, electrical contact, hot parts and exhaust.
- ⚠ Wear eye protection to guard from battery acid, compressed springs, fluids under pressure and flying debris when engines are running or tools are used. Use eye protection approved for type of welding.
- ⚠ Keep rear door closed except for service. Close and latch door before operating the loader.



B-6589

- ⚠ Lead-acid batteries produce flammable and explosive gases.
- ⚠ Keep arcs, sparks, flames and lighted tobacco away from batteries.
- ⚠ Batteries contain acid which burns eyes or skin on contact. Wear protective clothing. If acid contacts body, flush well with water. For eye contact flush well and get immediate medical attention.

Maintenance procedures which are given in the Operation & Maintenance Manual can be performed by the owner/operator without any specific technical training. Maintenance procedures which are **not** in the Operation & Maintenance Manual must be performed **ONLY BY QUALIFIED BOBCAT SERVICE PERSONNEL**. Always use genuine Bobcat replacement parts. The Service Safety Training Course is available from your Bobcat dealer.

MSW09-0409



Bobcat®



SERVICE SCHEDULE

Chart

Maintenance work must be done at regular intervals. Failure to do so will result in excessive wear and early failures. The service schedule is a guide for correct maintenance of the Bobcat loader.

<b style="font-size: 24px; margin-left: 10px;">WARNING	<p>Instructions are necessary before operating or servicing machine. Read and understand the Operation & Maintenance Manual, Operator's Handbook and signs (decals) on machine. Follow warnings and instructions in the manuals when making repairs, adjustments or servicing. Check for correct function after adjustments, repairs or service. Untrained operators and failure to follow instructions can cause injury or death.</p> <p style="text-align: right; font-size: 10px;">W-2003-0807</p>
--	--

SERVICE SCHEDULE		HOURS					
ITEM	SERVICE REQUIRED	8-10	50	100	■ 250	■ 500	■ 1000
Engine Oil	Check the oil level and add as needed. Do not overfill.						
Engine Air Filter and Air System	Service only when required. Check for leaks and damaged components.						
Engine Cooling System	Clean debris from oil cooler, radiator and grille. Check coolant level COLD and add premixed coolant as needed.						
Fuel Filter	Remove the trapped water.						
Lift Arms, Cylinders, Bob-Tach Pivot Pins and Wedges	Lubricate with multipurpose lithium based grease.						
Seat Bar, Control Interlocks, Seat Belt, Seat Belt Retractors	Check the condition of seat belt. Clean or replace seat belt retractors as needed. Check the seat bar and control interlocks for correct operation. Clean dirt and debris from moving parts.						
Bobcat Interlock Control Systems (BICS™)	Check for correct function. Lift and Tilt functions MUST NOT operate with seat bar raised. See details in this Manual.						
Front Horn	Check for proper function.						
Safety Signs and Safety Treads	Check for damaged signs (decals) and safety treads. Replace any signs or safety treads that are damaged or worn.						
Operator Cab	Check the fastening bolts, washers and nuts. Check the condition of the cab.						
Indicators and Lights	Check for correct operation of all indicators and lights.						
Heater Filters (If Equipped)	Clean or replace filters as needed.						
Hydraulic Fluid, Hoses and Tubelines	Check fluid level and add as needed. Check for damage and leaks. Repair or replace as needed.						
Tracks	Check for damaged or worn tracks and correct tension.	☐					
Parking Brake, Foot Pedals, Hand Controls and Steering Levers or Joysticks	Check for correct operation. Repair or adjust as needed.						
Spark Arrester Muffler	Clean the spark chamber.						
Battery	Check cables, connections and electrolyte level. Add distilled water as needed.						
Steering Lever Pivots	Grease fittings.						
Fuel Filter	Replace filter element.						
Engine / Hydro. Drive Belt	Check for wear or damage. Check idler arm stop.		▲				
Drive Belts (Alternator, water pump)	Check condition and tension. Adjust or replace as needed.						
Bobcat Interlock Control System (BICS™)	Check the function of the lift arm bypass control.						
Engine Oil and Filter	Replace oil and filter.		▲	*			
Track Sprocket Nuts	Check torque. Tighten as needed. See procedure in this manual.						
Hydraulic / Hydrostatic Filter, Charge Filter, Reservoir Breather	Replace the hydraulic / hydrostatic filter, charge filter, and the reservoir breather.		●				
Hydraulic Reservoir	Replace the fluid.						
Case Drain Filters	Replace the filters.		▲				
Engine Valves	Adjust the engine valves.					○	
Coolant	Replace the coolant						Every 2 years

- **Or every 12 months.**
- ▲ **Perform at first 50 hours, then as scheduled.**
- ☐ **Check every 8 - 10 hours for the first 24 hours, then at 50 hour intervals.**
- **Replace the hydraulic / hydrostatic filter element after the first 50 hours, then when service code [M0217] is displayed or as scheduled.**
- * **Change oil and filter every 100 hours when operating under severe conditions.**
- **Perform at first 500 hours, then as scheduled.**

NOTE: The Inspection Checkbook can be ordered for you by your local dealer. Part number 4420300.

SERVICE SCHEDULE (CONT'D)

Inspection Checkbook

Regularly scheduled maintenance is essential to continuous operation and operating safety. The life expectancy of your machine depends on proper and meticulous care.

The Inspection Checkbook contains the following information:

- Doosan Benelux S.A. Warranty Conditions
- Protection Plus Extended Warranty Conditions
- General Parts Policy
- General Information
- First Inspection
- Scheduled Services
- Identification
- Authorised Identification
- Lubricants and Fluids Table
- Service Parts Chart

Your local dealer can order the Inspection Checkbook. Part number: 4420300.

BOBCAT INTERLOCK CONTROL SYSTEM (BICS™)

Inspecting The BICS™ (Engine STOPPED - Key ON)

Figure 144

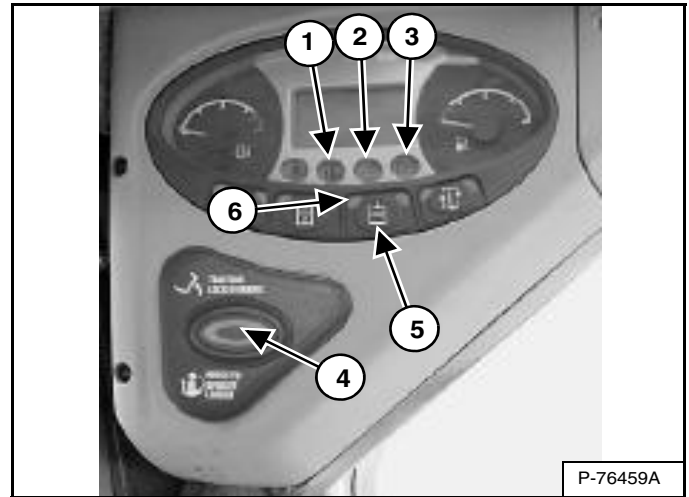

1. Sit in operator's seat. Turn key to RUN or press RUN button. Lower seat bar and disengage parking brake. Press the PRESS TO OPERATE LOADER button (Item 4). Two BICS™ lights (Items 1 and 2) [Figure 144] [SEAT BAR AND LIFT & TILT VALVE] on left instrument panel must be OFF. The PRESS TO OPERATE LOADER button will light.
2. Raise seat bar fully. All three BICS™ lights (Items 1, 2 and 3) [Figure 144] [SEAT BAR, LIFT & TILT VALVE AND PARKING BRAKE] on left instrument panel must be ON. The PRESS TO OPERATE LOADER button light will turn OFF.

Inspecting Deactivation Of The Auxiliary Hydraulics System (Engine STOPPED - Key ON)

3. Sit in operator's seat, lower seat bar and press the PRESS TO OPERATE LOADER button (Item 4). Press the auxiliary hydraulics button (Item 5). The auxiliary hydraulics light (Item 6) [Figure 144] will be ON. Raise the seat bar. The light must be OFF.



**BOBCAT INTERLOCK CONTROL SYSTEM (BICS™)
(CONT'D)**

Inspecting The Seat Bar Sensor (Engine RUNNING)

4. Sit in operator's seat, lower seat bar, engage parking brake and fasten seat belt.
5. Start engine and operate at low idle. Press the PRESS TO OPERATE LOADER button. While raising the lift arms, raise the seat bar fully. The lift arms must stop. Repeat using the tilt function.

Inspecting The Traction Lock (Engine RUNNING)

6. Fasten seat belt, disengage parking brake, press the PRESS TO OPERATE LOADER button and raise seat bar fully. Move steering levers or joystick(s) slowly forward and backward. The TRACTION lock must be engaged. Lower the seat bar. Press the PRESS TO OPERATE LOADER button.
7. Engage parking brake and move steering levers or joystick(s) slowly forward and backward. The TRACTION lock must be engaged.

NOTE: The PARKING BRAKE light on the left instrument panel will remain ON until the engine is started, the PRESS TO OPERATE LOADER button is pressed and the parking brake is disengaged.

Inspecting The Lift Arm Bypass Control

8. Raise the lift arms 2 m (6 ft) off the ground. Stop engine. Turn lift arm bypass control knob clockwise 1/4 turn. Pull up and hold lift arm bypass control knob until lift arms slowly lower.

Inspecting Deactivation Of Lift And Tilt Functions (SJC)

9. Sit in operator's seat and fasten seat belt. Lower seat bar, start engine and press the PRESS TO OPERATE LOADER button.
10. Raise lift arms about 2 m (6 ft) off the ground.
11. Turn key OFF or press STOP button, and wait for the engine to come to a complete stop.
12. Turn key ON or press RUN button. Press the PRESS TO OPERATE LOADER button, move the control (foot pedal, hand control or joystick) to lower the lift arms. Lift arms must not lower.
13. Move the control (foot pedal, hand control or joystick) to tilt the bucket (or attachment) forward. The bucket (or attachment) must not tilt forward.



AVOID INJURY OR DEATH

The Bobcat Interlock Control System (BICS™) must deactivate the lift, tilt and traction drive functions. If it does not, contact your dealer for service. DO NOT modify the system.

W-2151-1111

BOBCAT INTERLOCK CONTROL SYSTEM (BICS™) (CONT'D)

Inspecting Deactivation Of The Auxiliary Hydraulics System (Engine RUNNING)

Standard Controls (If Equipped)

Perform the procedures on flat level ground and make sure the area is clear of bystanders.

Figure 145

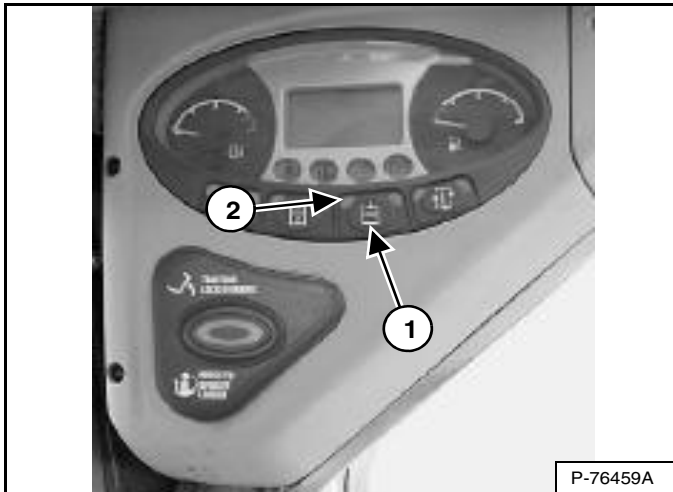

14. Install an attachment with hydraulic connections. (See Installing And Removing The Attachment (Hand Lever Bob-Tach) on Page 81.) or (See Installing And Removing The Attachment (Power Bob-Tach) on Page 83.) Perform the pre-starting procedure. (See PRE-STARTING PROCEDURE on Page 68.) Fasten the seat belt, lower the seat bar and make sure the parking brake is engaged. Start the engine. Move the auxiliary hydraulic control to the left or the right. (See FRONT Auxiliary Hydraulics Operation (Variable Flow) on Page 61.) There must not be hydraulic oil flow to the attachment.

Press the auxiliary hydraulics button (Item 1). The auxiliary hydraulics light (Item 2) [Figure 145] will be ON. Move the auxiliary hydraulic control to the left or the right. (See FRONT Auxiliary Hydraulics Operation (Variable Flow) on Page 61.) The auxiliary hydraulic oil will flow to the attachment.

15. Install an attachment with hydraulic connections. (See Installing And Removing The Attachment (Hand Lever Bob-Tach) on Page 81.) or (See Installing And Removing The Attachment (Power Bob-Tach) on Page 83.) Perform the pre-starting procedure. (See PRE-STARTING PROCEDURE on Page 68.) Fasten the seat belt, lower the seat bar and make sure the parking brake is engaged. Start the engine. Press the auxiliary hydraulics button (Item 1). The auxiliary hydraulics light (Item 2) [Figure 145] will be ON. Move the auxiliary hydraulic control to the left or the right. (See FRONT Auxiliary Hydraulics Operation (Variable Flow) on Page 61.) Raise the seat bar. The auxiliary hydraulic oil flow to the attachment must STOP.

SEAT BAR RESTRAINT SYSTEM

Description

The seat bar restraint system has a pivoting seat bar with armrests.

The operator controls the use of the seat bar. The seat bar in the down position helps to keep the operator in the seat.

Models With Standard Controls have hydraulic valve spool interlocks for the lift and tilt functions. The spool interlocks require the operator to lower the seat bar in order to operate the foot pedal controls.

When the seat bar is down, the PRESS TO OPERATE LOADER button is activated and the engine is running, the lift, tilt and traction drive functions can be operated.

When the seat bar is up, the lift and tilt control pedals are locked when returned to the NEUTRAL position.

Models With Selectable Joystick Controls (SJC) have electrical deactivation of joystick functions. Activation of functions require the operator to lower the seat bar.

When the seat bar is down, the PRESS TO OPERATE LOADER button is activated and the engine is running, the lift, tilt and traction drive functions can be operated.

When the seat bar is up, the joystick functions are deactivated even though the joystick does not mechanically lock.

Inspecting

Sit in the seat and fasten the seat belt. Engage the parking brake. Pull the seat bar all the way down. Start the engine. Press the PRESS TO OPERATE LOADER button.

Operate the hydraulic controls to check that both the lift and tilt functions operate correctly. Raise the lift arms until the attachment is about 600 mm (2 ft) off the ground.

Raise the seat bar. Move the hydraulic controls. Pedals (if equipped) must be firmly locked in the NEUTRAL position. There must be no motion of the lift arms or tilt (attachment) when the controls are moved.

Lower the seat bar, press the PRESS TO OPERATE LOADER button, lower the lift arms. Operate the lift control. While the lift arms are going up, raise the seat bar. The lift arms must stop.

Lower the seat bar, press the PRESS TO OPERATE LOADER button, lower the lift arms and put the attachment flat on the ground. Stop the engine. Raise the seat bar. Operate the foot pedals (if equipped) to be sure they are firmly locked in the NEUTRAL position.

Maintaining

See the service schedule for correct service interval. (See SERVICE SCHEDULE on Page 105.)

Figure 146

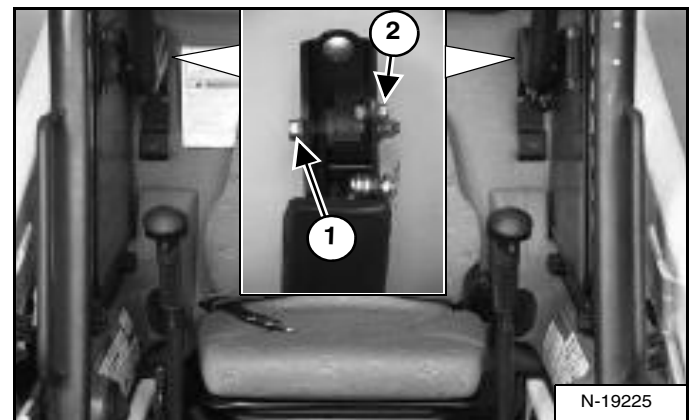

Use compressed air to clean any debris or dirt from the pivot parts. Do not lubricate. Inspect all mounting hardware. The correct hinge bolt (Item 1) torque is 34 - 38 N•m (25 - 28 ft-lb). The seat bar sensor nut (left side only) (Item 2) [Figure 146] torque is 6 - 8 N•m (50 - 70 in-lb).

If the seat bar system does not function correctly, replace parts that are worn or damaged. Use only genuine Bobcat replacement parts.

WARNING

The seat bar system must deactivate the lift and tilt control functions when the seat bar is up. See your Bobcat dealer for service if hydraulic controls do not deactivate.

W-2465-111

SEAT BELT

Inspection And Maintenance

! WARNING

Failure to properly inspect and maintain the seat belt can cause lack of operator restraint resulting in serious injury or death.

W-2466-0703

Check the seat belt daily for correct function.

Inspect the seat belt system thoroughly at least once each year or more often if the machine is exposed to severe environmental conditions or applications.

Any seat belt system that shows cuts, fraying, extreme or unusual wear, significant discolourations due to ultraviolet UV exposure, dusty / dirty conditions, abrasion to the seat belt webbing, or damage to the buckle, latch plate, retractor (if equipped), hardware or any other obvious problem should be replaced immediately.

The items below are referenced in **[Figure 147]**.

1. Check the webbing. If the system is equipped with a retractor, pull the webbing completely out and inspect the full length of the webbing. Look for cuts, wear, fraying, dirt and stiffness.
2. Check the buckle and latch for correct operation. Make sure latch plate is not excessively worn, deformed or buckle is not damaged or casing broken.
3. Check the retractor web storage device (if equipped) by extending webbing to determine if it looks correct and that it spools out and retracts webbing correctly.
4. Check webbing in areas exposed to ultraviolet (UV) rays from the sun or extreme dust or dirt. If the original colour of the webbing in these areas is extremely faded and / or the webbing is packed with dirt, the webbing strength may have deteriorated.

See your Bobcat dealer for seat belt system replacement parts for your machine.

Figure 147

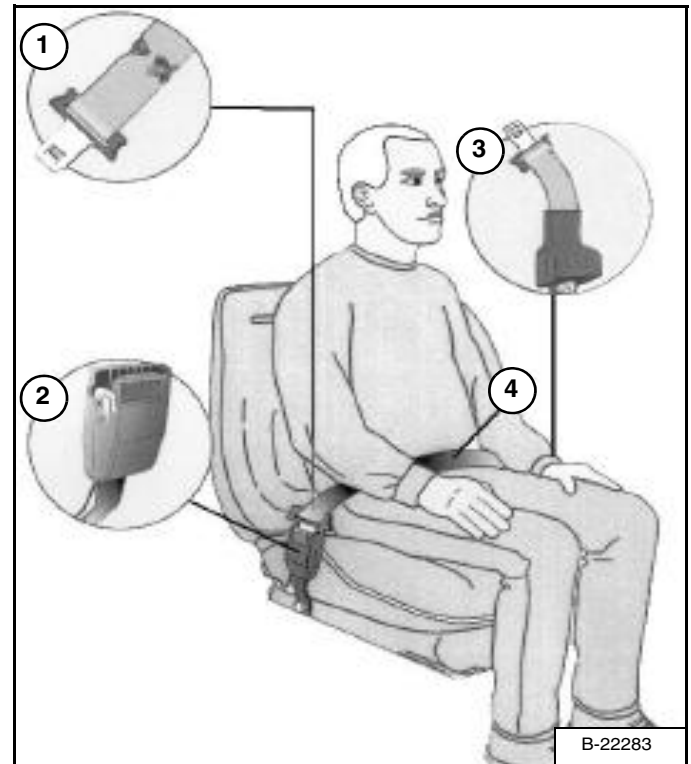

LIFT ARM SUPPORT DEVICE

Installing

Maintenance and service work can be done with the lift arms lowered. If the lift arms are raised, use the following procedures to engage and disengage an approved lift arm support device.



Never work on a machine with the lift arms up unless the lift arms are secured by an approved lift arm support device. Failure to use an approved lift arm support device can allow the lift arms or attachment to fall and cause injury or death.

Service lift arm support device if damaged or if parts are missing. Using a damaged lift arm support or with missing parts can cause lift arms to drop causing injury or death.

W-2572-0407



P-90328

AVOID DEATH

- Disconnecting or loosening any hydraulic tubeline, hose, fitting, component or a part failure can cause lift arms to drop.
- Keep out of this area when lift arms are raised unless supported by an approved lift arm support. Replace if damaged.

D-1009-0409

Remove attachment from the loader. (See Installing And Removing The Attachment (Hand Lever Bob-Tach) on Page 81.) **OR** (See Installing And Removing The Attachment (Power Bob-Tach) on Page 83.)



Before the cab or the lift arms are raised for service, jackstands must be put under the rear corners of the frame. Failure to use jackstands can allow the machine to tip backward causing injury or death.

W-2014-0895

Figure 148

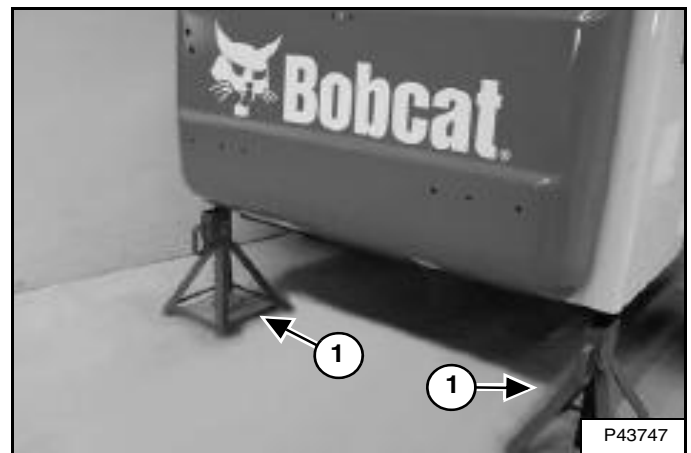

Install jackstands (Item 1) [Figure 148] under the rear corners of the loader frame.

Figure 149

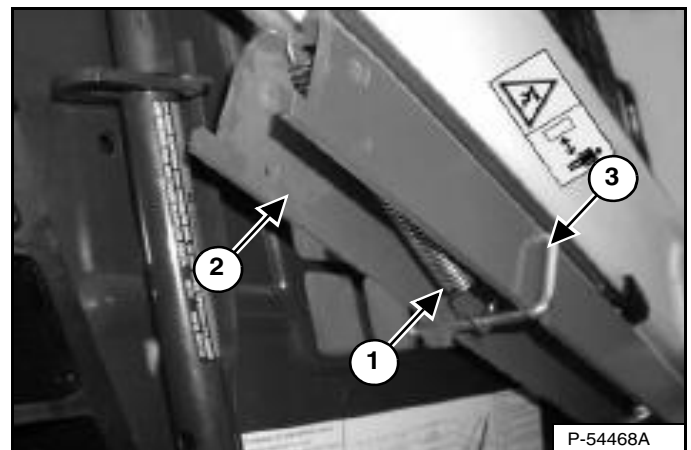

Disconnect the spring (Item 1) from the lift arm support device retaining pin. Support the lift arm support device (Item 2) with your hand and remove the retaining pin (Item 3) [Figure 149].

LIFT ARM SUPPORT DEVICE (CONT'D)

Installing (Cont'd)

Figure 150

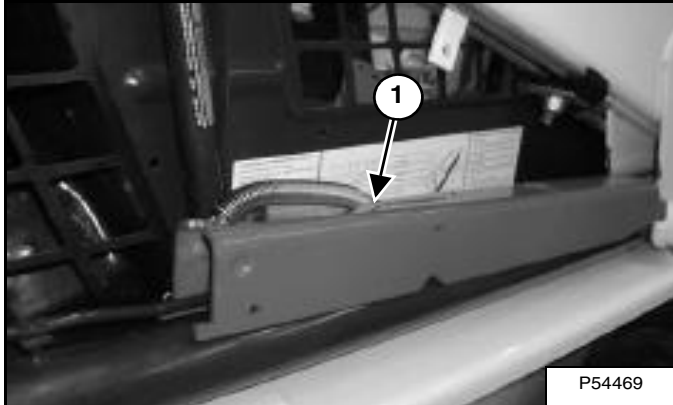

Lower the lift arm support device to the top of the lift cylinder. Hook the free end of the spring (Item 1) [Figure 150] to the lift arm support device so the spring does not interfere with the support device engagement.

Sit in the operator's seat, fasten the seat belt and lower the seat bar. Start the engine.

Figure 151

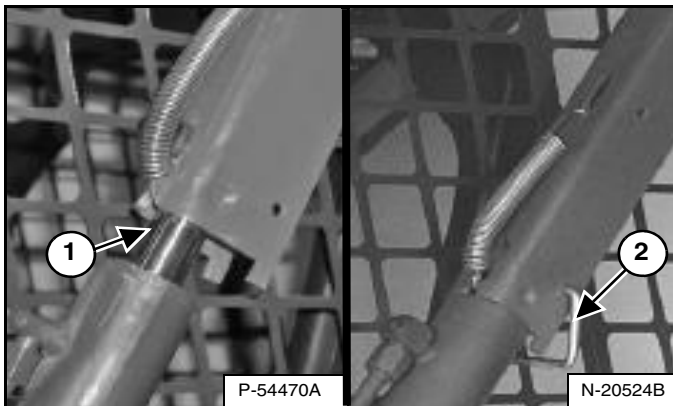

Raise the lift arms until the lift arm support device drops onto the lift cylinder rod (Item 1) [Figure 151].

Lower the lift arms slowly until the support device is held between the lift arm and the lift cylinder. Stop the engine.

Raise the seat bar, disconnect the seat belt and move the pedals until both lock.

Install the retaining pin (Item 2) [Figure 151] into the rear of the lift arm support device below the cylinder rod.

Removing

Remove the retaining pin (Item 2) [Figure 151] from the lift arm support device.

Figure 152



Connect the spring (Item 1) [Figure 152] from the lift arm support device to the bracket below the lift arms.

Sit in the operator's seat, fasten the seat belt and lower the seat bar. Start the engine.

Figure 153

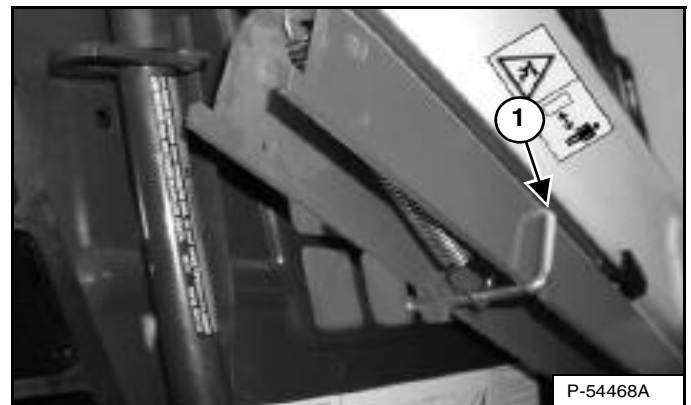

Raise the lift arms a small amount. The spring will lift the support device off the lift cylinder rod. Lower the lift arms. Stop the engine.

Raise the seat bar, unbuckle the seat belt, move the pedals until both lock and exit the cab.

Disconnect the spring from the bracket.

Raise the support device into storage position and insert the retaining pin (Item 1) [Figure 153] through the lift arm support device and through the bracket. Connect the spring to the retaining pin.

Remove the jackstands.

BACK-UP ALARM SYSTEM

Description

The back-up alarm will sound when the operator moves both steering levers or joystick(s) into the reverse position. Slight movement of the steering levers into the reverse position is required with hydrostatic transmissions, before the back-up alarm will sound.

Inspecting

Figure 154



Inspect for damaged or missing back-up alarm decal (Item 1) [Figure 154]. Replace if required.

Sit in the seat and fasten the seat belt. Engage the parking brake. Pull the seat bar all the way down. Start the engine. Press the PRESS TO OPERATE LOADER button. Disengage the parking brake.

Move both steering levers or joystick(s) into the reverse position. The back-up alarm must sound when all wheels or both tracks are moving in reverse.

The back-up alarm is located on the inside of the rear door.

Figure 155

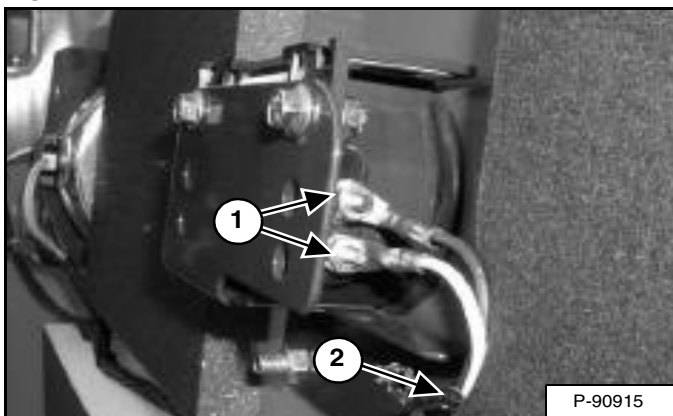

Inspect the back-up alarm electrical connections (Item 1) [Figure 155], wire harness (Item 2) [Figure 155] and back-up alarm switches (if equipped) (Item 2) [Figure 156] for tightness and damage. Repair or replace any damaged components.

If the back-up alarm switches require adjustment, (See Adjusting Switch Position on Page 113.)

Adjusting Switch Position

NOTE: Joystick equipped machines do not have back-up alarm switches and cannot be adjusted. See your Bobcat dealer for service if your back-up alarm does not sound.

Standard Controls (If Equipped)

Stop the engine and raise the operator cab. (See Raising on Page 114.)

Figure 156

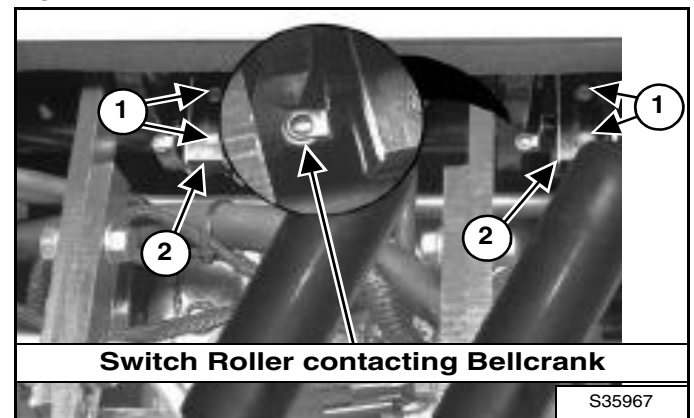

Place the steering levers in the neutral position.

Loosen the screws (Item 1) [Figure 156] securing the back-up alarm switches.

Position the back-up alarm switch rollers so that they just make contact with bellcranks without compressing the switch springs [Figure 156]. Torque the screws (Item 1) [Figure 156] securing the switches to the bracket to 1,6 - 2,1 N•m (14 - 19 in-lb).

Lower the operator cab (See Lowering on Page 115.) and inspect back-up alarm system for proper function. (See Inspecting on Page 113.)

OPERATOR CAB

Description

The Bobcat loader has an operator cab (ROPS and FOPS) as standard equipment to protect the operator from rollover and falling objects. The seat belt must be worn for rollover protection.

Check the ROPS / FOPS cab, mounting and hardware for damage. Never modify the ROPS /FOPS cab. Replace the cab and hardware if damaged. See your Bobcat dealer for parts.

ROPS / FOPS - Roll Over protective Structure per ISO 3471, and Falling Object Protective Structure per ISO 3449, Level I. Level II is available.

Level I

Protection from falling bricks, small concrete blocks, and hand tools encountered in operations such as motorway maintenance, landscaping, and other construction sites.

Level II

Protection from falling trees, rocks: for machines involved in site clearing, overhead demolition or forestry.

WARNING

Never modify operator cab by welding, grinding, drilling holes or adding attachments unless instructed to do so by Bobcat Company. Changes to the cab can cause loss of operator protection from rollover and falling objects, and result in injury or death.

W-2069-0200

Raising

Always stop the engine before raising or lowering the cab.

Stop the loader on a level surface. Lower the lift arms. If the lift arms must be up while raising the operator cab, install the lift arm support device. (See LIFT ARM SUPPORT DEVICE on Page 111.)

WARNING

Before the cab or the lift arms are raised for service, jackstands must be put under the rear corners of the frame. Failure to use jackstands can allow the machine to tip backward causing injury or death.

W-2014-0895

Figure 157



Install jackstands under the rear of the loader frame [Figure 157].

Figure 158

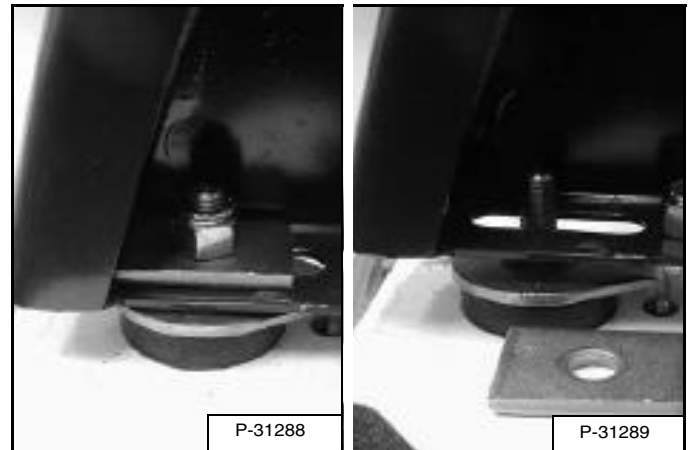

Remove the nut and plate [Figure 158] (both sides) at the front corners of the cab.

NOTE: Move the engine speed control lever forward before raising the operator cab to prevent damage to lever or cab.

OPERATOR CAB (CONT'D)

Raising (Cont'd)

Figure 159



Lift on the grab handles and bottom of the operator cab [Figure 159] slowly until the cab is all the way up and the latching mechanism engages.

Lowering

Always stop the engine before raising or lowering the cab.

NOTE: Always use the grab handles to lower the cab.

NOTE: Move the engine speed control lever forward before lowering the operator cab to prevent damage to lever or cab.

Figure 160



Pull down on the bottom of the operator cab until it stops at the latching mechanism [Figure 160].

NOTE: The weight of the cab increases when equipped with options and accessories such as cab door, heater, etc. In these cases, the cab may need to be raised slightly from the latch to be able to release the latch.

Support the cab and release the latching mechanism (Inset) [Figure 160]. Remove your hand from the latch mechanism when the cab is past the latch stop. Use both hands to lower the cab all the way down.



PINCH POINT CAN CAUSE INJURY
Remove your hand from the latching mechanism when the cab is past the latch stop.

W-2469-0803

Figure 161

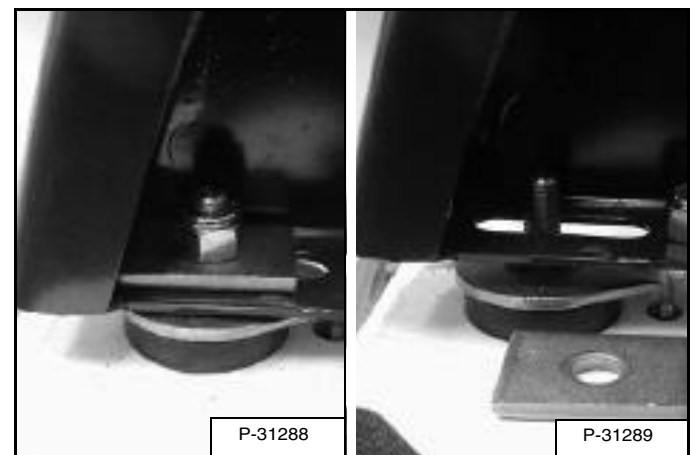

Install the plates and nuts (both sides) [Figure 161].

Tighten the nuts to 54 - 61 N•m (40 - 45 ft-lb) torque.

OPERATOR CAB (CONT'D)

Cab Door Sensor

This machine may be equipped with a Cab Door Sensor.

Figure 162

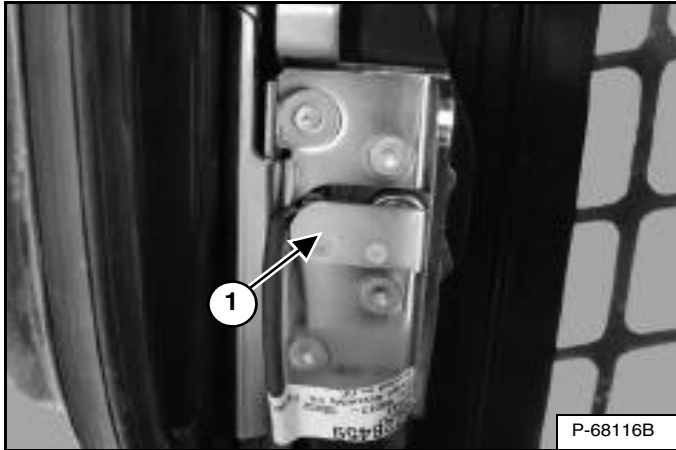

The cab door has a sensor (Item 1) [Figure 162] installed which deactivates the lift and tilt valves when the door is open.

Figure 163



The LIFT & TILT VALVE light (Item 1) [Figure 163] will be OFF when the door is closed, the key switch is turned to RUN or the RUN / ENTER button is pressed, the seat bar is lowered and the PRESS TO OPERATE LOADER button is pressed.

Figure 164



The LIFT & TILT VALVE light (Item 1) [Figure 163] will be ON when the door is open, the key switch is turned to RUN or the RUN / ENTER button is pressed, the seat bar is lowered and the PRESS TO OPERATE LOADER button is pressed.

[DOOR] will appear in the data display [Figure 164].

REAR DOOR (TAILGATE)

Opening And Closing

Figure 165

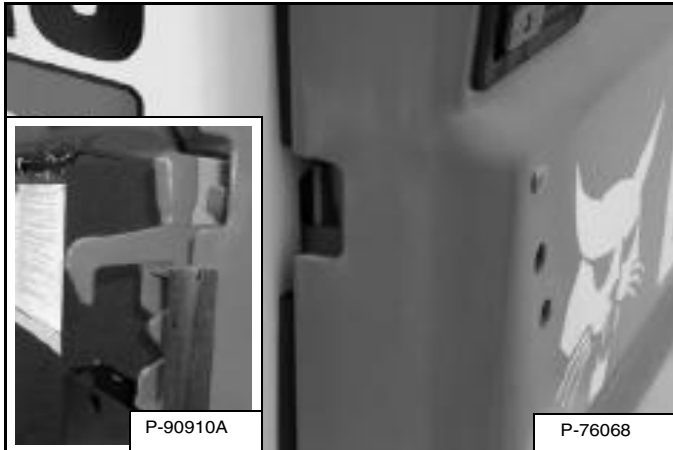

Reach into the slot in the rear door and pull the latch handle [Figure 165].

Pull the rear door open.

Figure 166

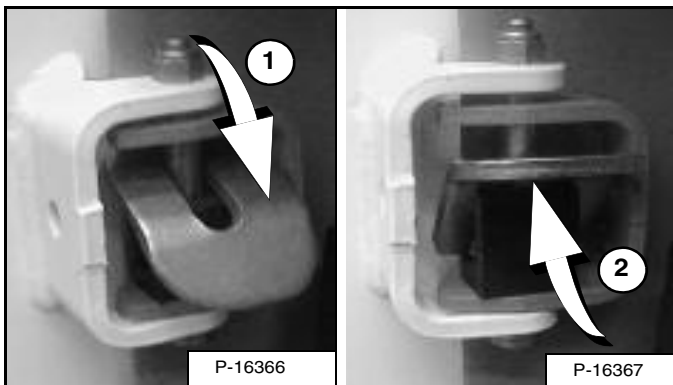

Move the door stop into the engaged position (Item 1) [Figure 166] to hold the door open.

Move the door stop up (Item 2) [Figure 166] to disengage the door stop and allow the door to close.

Close the rear door.



Keep the rear door closed when operating the machine. Failure to do so could seriously injure a bystander.

W-2020-1285

Adjusting

Figure 167

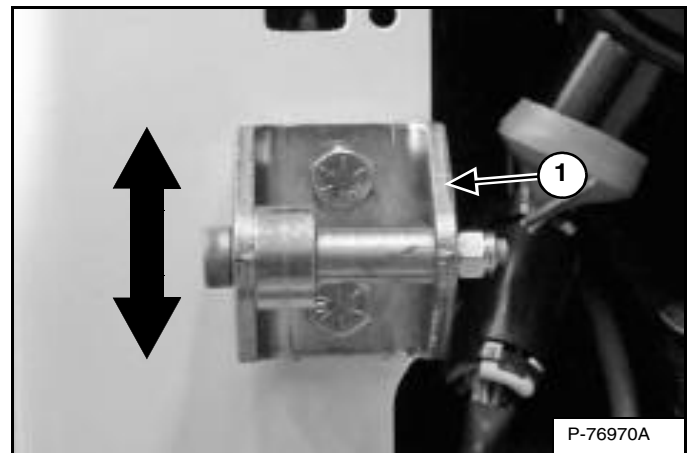

The door latch (Item 1) [Figure 167] can be adjusted up or down for alignment with the door latch mechanism.

Close the rear door before operating the loader.

REAR GRILLE

Removing

Open the rear door.

Figure 168

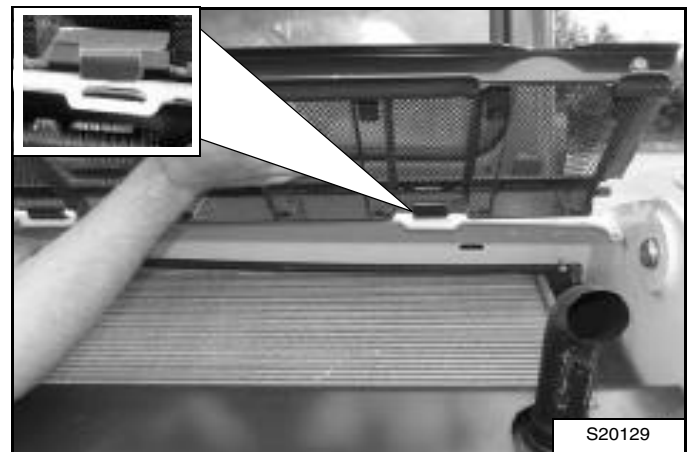

Lift and pull the rear grille to remove it from the loader [Figure 168].

Installing

Align the tabs of the rear grille into the slots in the loader frame (Inset) [Figure 168].

Lower the rear grille and close the rear door.

HEATING SYSTEM

This machine may be equipped with a Heating System.

Cleaning And Maintenance

The heating system requires regular inspection and maintenance. (See SERVICE SCHEDULE on Page 105.)

Filters

Figure 169

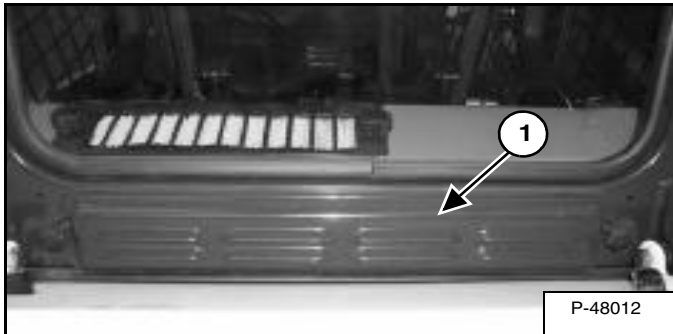

The *Fresh Air Filter* (Item 1) [Figure 169] is located below the rear window outside the cab. Remove the clamping knobs, filter cover and filter.

Shake the filter or use low pressure air to remove dirt. This can be done several times before replacement is required. Install the filter, filter cover and clamping knobs.

Figure 170

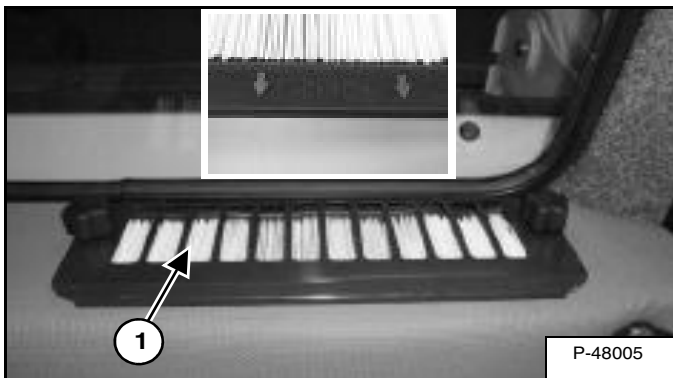

The *Recirculation Filter* (Item 1) [Figure 170] is located in front of the rear window inside the cab. Remove the clamping knobs, filter cover, and filter.

Shake the filter or use a vacuum to clean. This can be done several times before replacement is required. Install the filter with the arrows pointing forward (Inset) [Figure 170], install the filter cover and clamping knobs.

Heater Coil

Raise the operator cab. (See Raising on Page 114.)

Figure 171

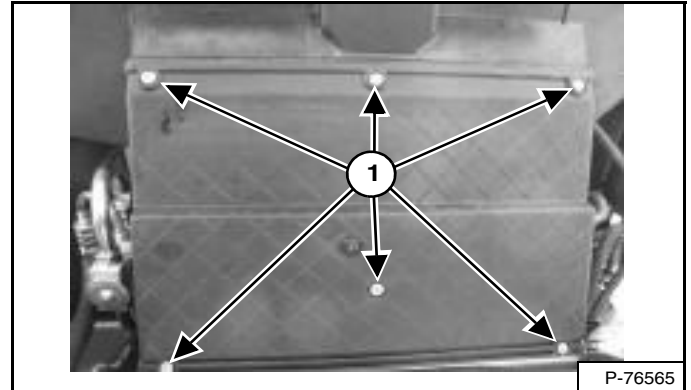

Remove the cover screws (Item 1) [Figure 171] and remove the cover.

Figure 172

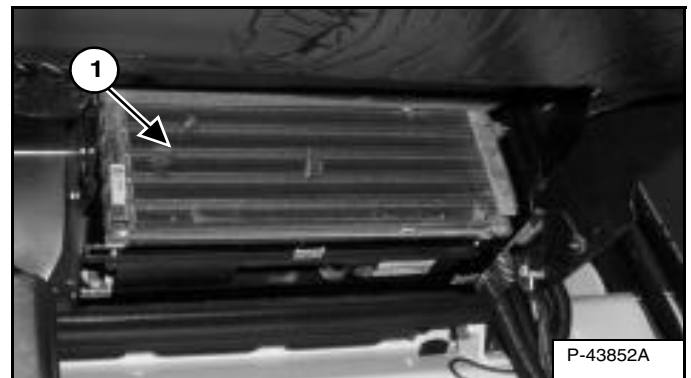

Use low pressure air or water to remove debris from the heater coil (Item 1) [Figure 172].

Install the cover and lower the operator cab. (See Lowering on Page 115.)

Troubleshooting

If the fan does not run, check the fuse. (See ELECTRICAL SYSTEM on Page 128.)

AIR CLEANER SERVICE

Replacing Filter Elements

Open the rear door. (See REAR DOOR (TAILGATE) on Page 117.)

Figure 173

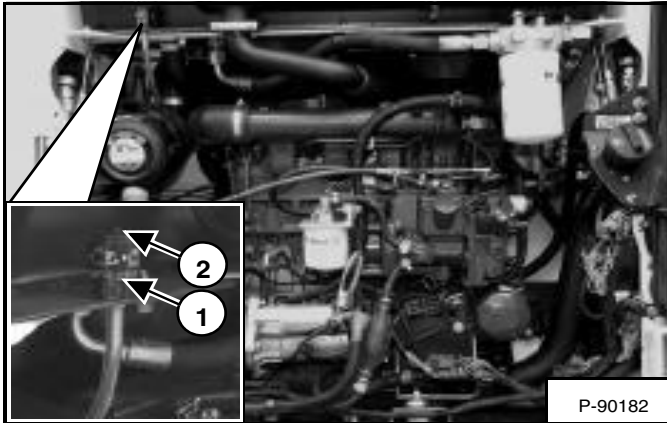

Replace the large (outer) filter element only when the red ring shows in the window of the condition indicator (Item 1) [Figure 173].

NOTE: Before replacing the filter element, push the button on the condition indicator (Item 2) [Figure 173]. Start the engine. If the red ring does not show, do not replace the filter element.

Outer Filter

Figure 174

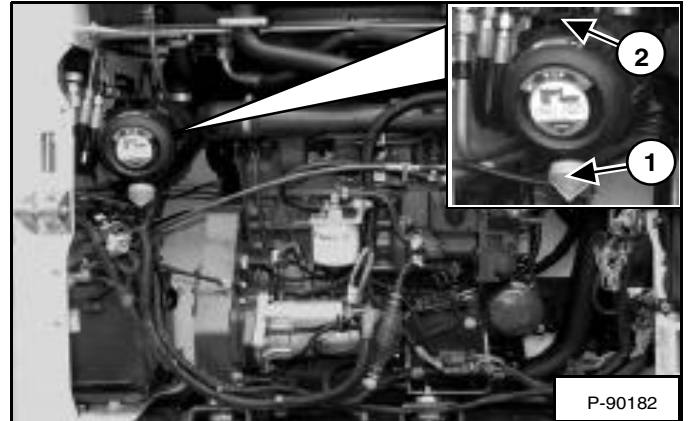

Open the evacuator valve (Item 1) [Figure 174] to get rid of large particles of dust and dirt.

Remove the dust cover by lifting the lever (Item 2) [Figure 174].

Figure 175

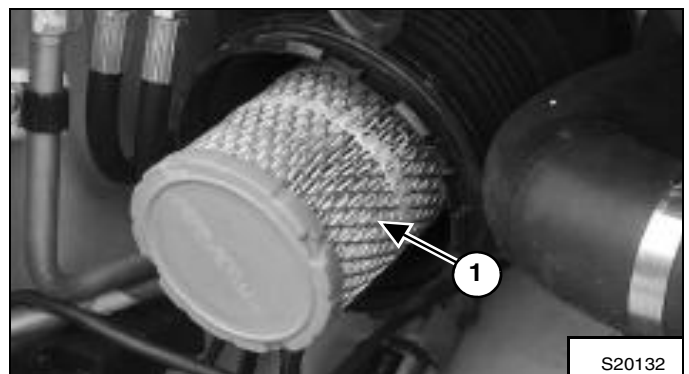

Pull the outer element (Item 1) [Figure 175] straight out.

Install a new outer element.

Install the dust cover.

Check the air intake hose and the air cleaner housing for damage. Make sure all connections are tight.

AIR CLEANER SERVICE (CONT'D)

Replacing Filter Elements (Cont'd)

Inner Filter

Replace the inner filter element every third time the outer filter is replaced or when the red ring still shows in the indicator window after the outer filter has been replaced.

Figure 176

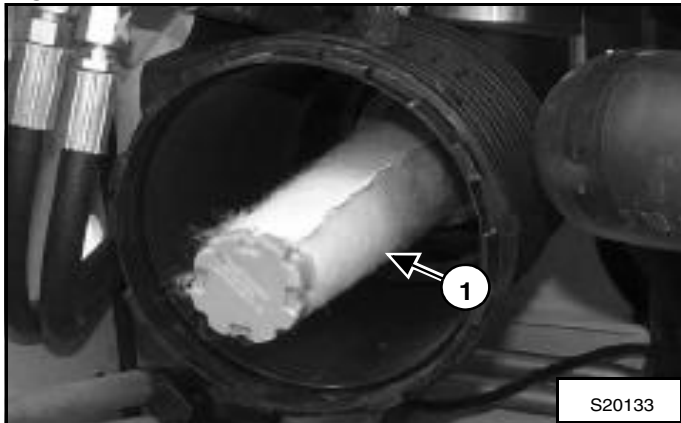

Remove the inner element (Item 1) [Figure 176].

NOTE: Make sure all sealing surfaces are free of dirt and debris.

Install new inner element.

Install the outer element.

Install the dust cover.

Close the rear door.



FUEL SYSTEM

Fuel Specifications

Use only clean, high quality diesel fuel, Grade No. 2 or Grade No. 1.

The following is one suggested blending guideline which should prevent fuel gelling during cold temperatures:

TEMPERATURE C° (F°)	NO. 2	NO. 1
-9° (+15°)	100%	0%
Down to -29° (-20°)	50%	50%
Below -29° (-20°)	0%	100%

At a minimum, low sulfur diesel fuel must be used in this machine. Low sulfur is defined as 500 mg/kg (500 ppm) sulfur maximum.

The following fuels may also be used in this machine:

- Ultra low sulfur diesel fuel. Ultra low sulfur is defined as 15mg/kg (15 ppm) sulfur maximum.
- Biodiesel blend fuel - Must contain no more than five percent biodiesel mixed with low sulfur or ultra low sulfur petroleum based diesel. This is commonly marketed as B5 blended diesel fuel. B5 blended diesel fuel must meet ASTM D975 (US Standard) or EN590 (EU Standard) specifications.

Biodiesel Blend Fuel

Biodiesel blend fuel has unique qualities that should be considered before using in this machine:

- Cold weather conditions can lead to plugged fuel system components and hard starting.
- Biodiesel blend fuel is an excellent medium for microbial growth and contamination which can cause corrosion and plugging of fuel system components.
- Use of biodiesel blend fuel may result in premature failure of fuel system components, such as plugged fuel filters and deteriorated fuel lines.
- Shorter maintenance intervals may be required, such as cleaning the fuel system and replacing fuel filters and fuel lines.
- Using biodiesel blended fuels containing more than five percent biodiesel can affect engine life and cause deterioration of hoses, tubelines, injectors, injector pump and seals.

Apply the following guidelines if biodiesel blend fuel is used:

- Ensure the fuel tank is as full as possible at all times to prevent moisture from collecting in the fuel tank.
- Ensure that the fuel tank cap is securely tightened.
- Biodiesel blend fuel can damage painted surfaces, remove all spilled fuel from painted surfaces immediately.
- Drain all water from the fuel filter daily before operating the machine.
- Do not exceed engine oil change interval. Extended oil change intervals can cause engine damage.
- Before vehicle storage; drain the fuel tank, refill with 100% petroleum diesel fuel, add fuel stabiliser and run the engine for at least 30 minutes.

NOTE: Biodiesel blend fuel does not have long term stability and should not be stored for more than three months.

FUEL SYSTEM (CONT'D)

Filling The Fuel Tank

! WARNING

AVOID INJURY OR DEATH

Stop and cool the engine before adding fuel. **NO SMOKING!** Failure to obey warnings can cause an explosion or fire.

W-2063-0807

Open the rear door. (See REAR DOOR (TAILGATE) on Page 117.)

Figure 177

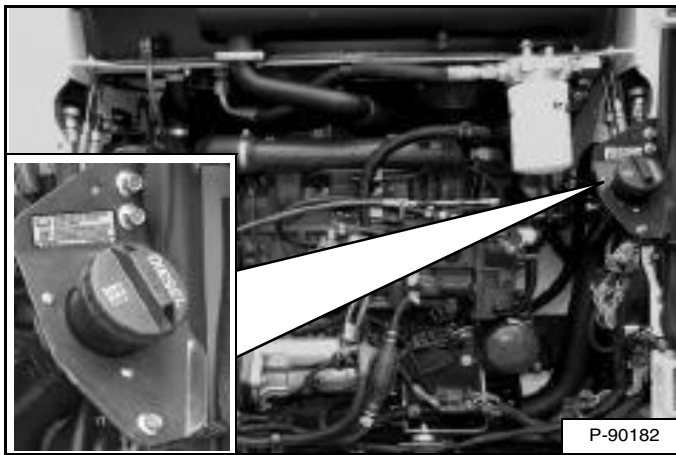

Remove the fill cap (Inset) [Figure 177].

Figure 178

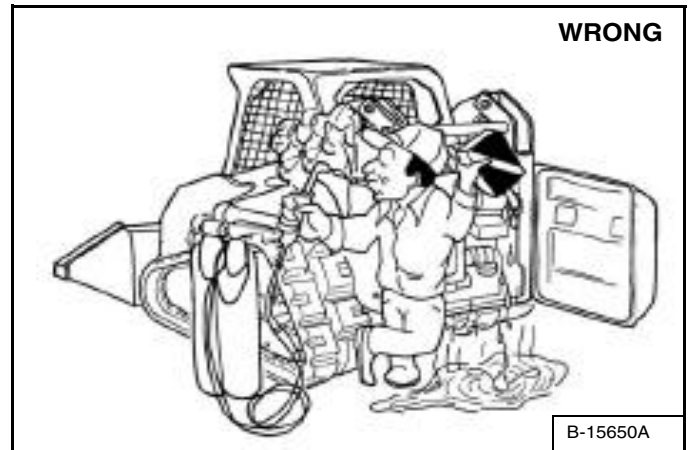

Use a clean, approved safety container to add fuel of the correct specification. Add fuel only in an area that has free movement of air and no open flames or sparks **NO SMOKING!** [Figure 178].

Install and tighten the fuel cap (Inset) [Figure 177].

Close the rear door.

! WARNING

AVOID INJURY OR DEATH

Always clean up spilled fuel or oil. Keep heat, flames, sparks or lighted tobacco away from fuel and oil. Failure to use care around combustibles can cause explosion or fire.

W-2103-0508

FUEL SYSTEM (CONT'D)

Fuel Filter

For the service interval for removing water from, or replacing the fuel filter (See SERVICE SCHEDULE on Page 105.)

Removing Water

Figure 179

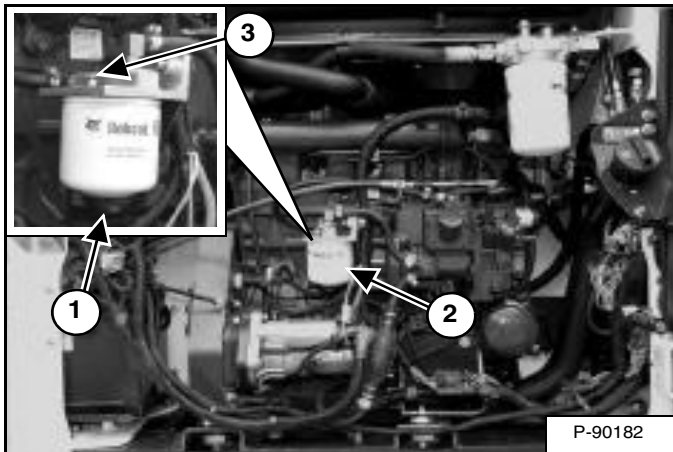

Loosen the drain (Item 1) [Figure 179] at the bottom of the filter element to remove water from the filter.

Replacing Element

Remove the filter element (Item 2) [Figure 179].

Clean the area around the filter housing. Put clean oil on the seal of the new filter element. Install the fuel filter, and hand tighten.

Remove air from the fuel system. (See Removing Air From The Fuel System on Page 123.)



AVOID INJURY OR DEATH

Always clean up spilled fuel or oil. Keep heat, flames, sparks or lighted tobacco away from fuel and oil. Failure to use care around combustibles can cause explosion or fire.

W-2103-0508

Removing Air From The Fuel System

After replacing the filter element or when the fuel tank has run out of fuel, the air must be removed from the fuel system before starting the engine.



AVOID INJURY OR DEATH

Diesel fuel or hydraulic fluid under pressure can penetrate skin or eyes, causing serious injury or death. Fluid leaks under pressure may not be visible. Use a piece of cardboard or wood to find leaks. Do not use your bare hand. Wear safety goggles. If fluid enters skin or eyes, get immediate medical attention from a physician familiar with this injury.

W-2072-0807

Figure 180

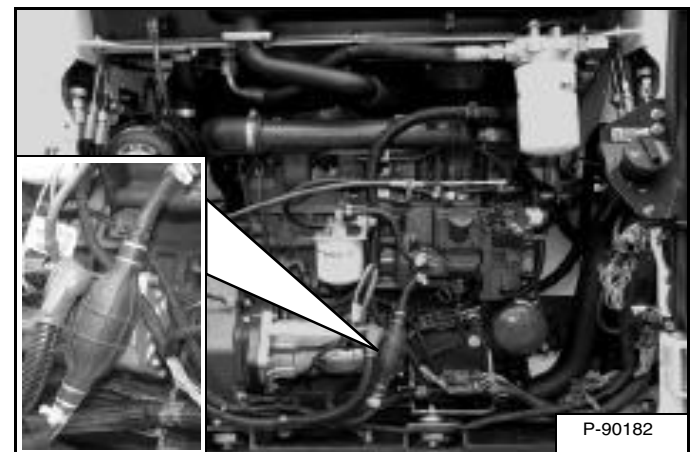

Open the vent (Item 3) [Figure 179] on the fuel filter housing.

Squeeze the hand pump (priming bulb) (Inset) [Figure 180] until fuel flows from the vent with no air bubbles.

Close the vent (Item 3) [Figure 179] on the fuel filter housing.

Start the engine.

ENGINE LUBRICATION SYSTEM

Checking And Adding Engine Oil

Check the engine oil level every day before starting the engine for the work shift.

Figure 181

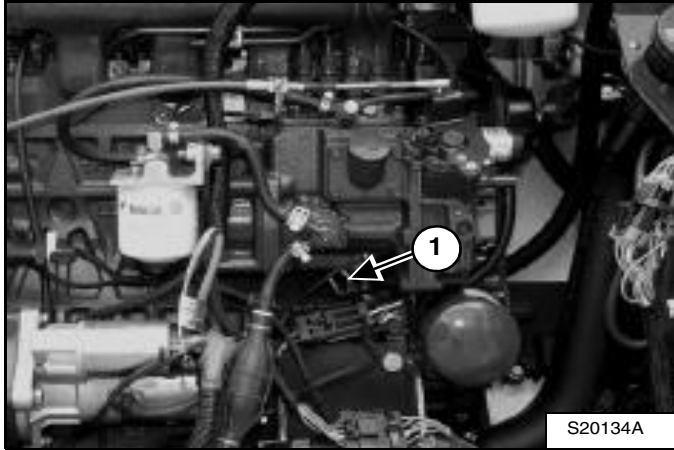

Park the machine on level ground. Open the rear door and remove the dipstick (Item 1) [Figure 181].

Keep the oil level between the marks on the dipstick. Do not overfill.

Engine Oil Chart

Figure 182

ENGINE OIL RECOMMENDED SAE VISCOSITY NUMBER (LUBRICATION OILS FOR DIESEL ENGINE CRANKCASE)

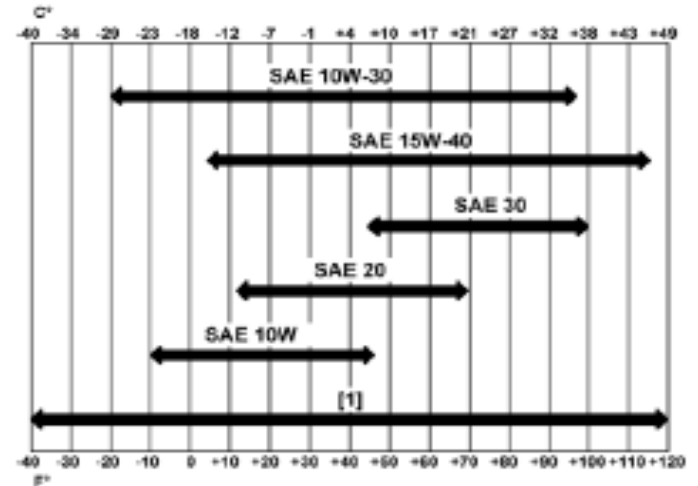

TEMPERATURE RANGE ANTICIPATED BEFORE
NEXT OIL CHANGE (DIESEL ENGINES MUST USE API
CLASSIFICATION CI-4 OR BETTER)

[1] Synthetic Oil - Use recommendation from Synthetic Oil Manufacturer.

Use good quality engine oil that meets API Service Classification of CI-4 or better [Figure 182].

ENGINE LUBRICATION SYSTEM (CONT'D)

Removing And Replacing Oil And Filter

For the service interval for replacing the engine oil and filter (See SERVICE SCHEDULE on Page 105.)

Run the engine until it is at operating temperature. Stop the engine.

Figure 183

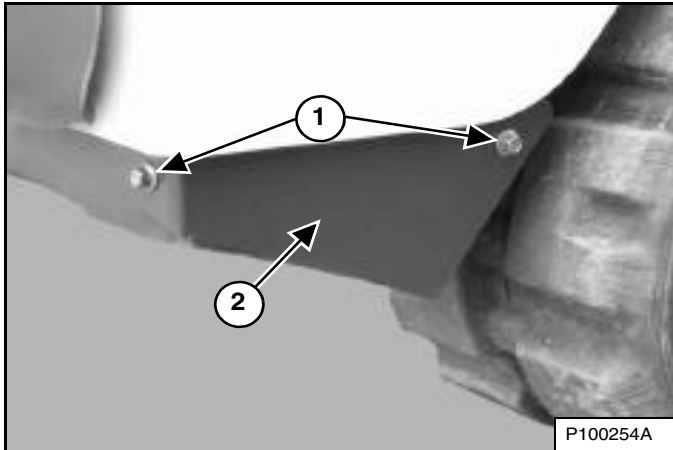

This machine may be equipped with a cover on the right rear corner [Figure 183].

Remove the bolts (Item 1) and cover (Item 2) [Figure 183].

NOTE: Some machines use one bolt to hold the cover in place.

Figure 184

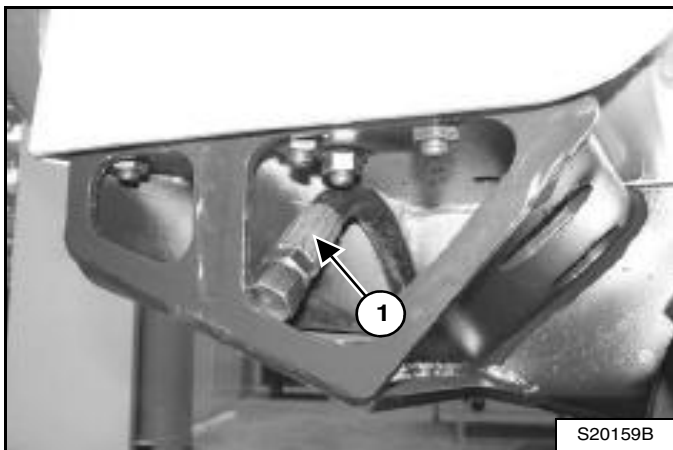

Remove the drain hose (Item 1) [Figure 184] from its storage position.

Remove the drain hose cap and drain the oil into a container. Recycle or dispose of used oil in an environmentally safe manner.

Open the rear door. (See REAR DOOR (TAILGATE) on Page 117.)

Figure 185

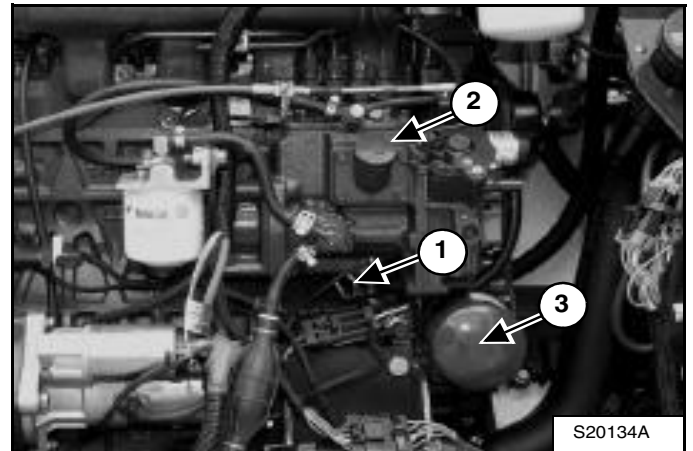

Remove the oil filter (Item 3) [Figure 185] and clean the filter housing surface. Put clean oil on the new oil filter gasket, install new filter and hand tighten.

Install and tighten the drain hose cap. Return the drain hose to its storage position [Figure 184].

Install the cover (Item 2) and bolts (Item 1) [Figure 183], if equipped.

Remove the fill cap (Item 2) [Figure 185]. Put oil in the engine. For the correct quantity (See Capacities on Page 168.) Do not overfill.

Start the engine and let it run for several minutes. Stop the engine and check for leaks at the oil filter.

Remove the dipstick (Item 1) [Figure 181] and check the oil level. Add oil as needed if it is not at the top mark on the dipstick. Install the dipstick and close the rear door.

WARNING

AVOID INJURY OR DEATH

Always clean up spilled fuel or oil. Keep heat, flames, sparks or lighted tobacco away from fuel and oil. Failure to use care around combustibles can cause explosion or fire.

W-2103-0508

ENGINE COOLING SYSTEM

Check the cooling system every day to prevent overheating, loss of performance or engine damage.

WARNING

AVOID INJURY OR DEATH

Wear safety glasses to prevent eye injury when any of the following conditions exist:

- When fluids are under pressure.
- Flying debris or loose material is present.
- Engine is running.
- Tools are being used.

W-2019-0907

Cleaning

Open the rear door. (See REAR DOOR (TAILGATE) on Page 117.)

Remove the rear grille. (See REAR GRILLE on Page 117.)

Figure 186

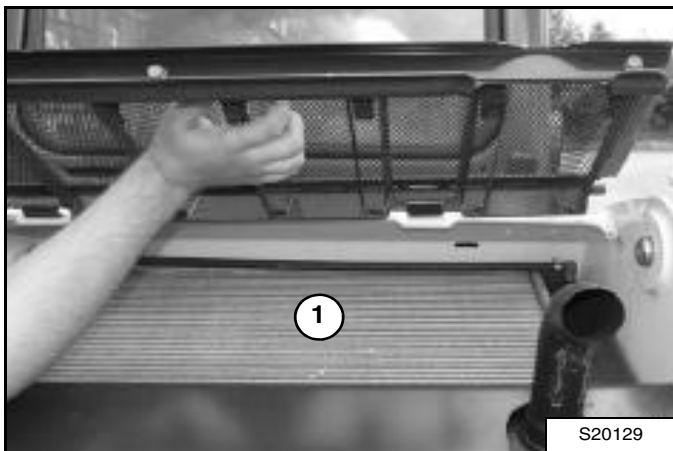

Use low air pressure or water pressure to clean the top of the radiator (Item 1) [Figure 186].

Check the cooling system for leaks.

Install the rear grille and close the rear door.

Checking Level

Open the rear door. (See REAR DOOR (TAILGATE) on Page 117.)

Remove the rear grille. (See REAR GRILLE on Page 117.)

Figure 187

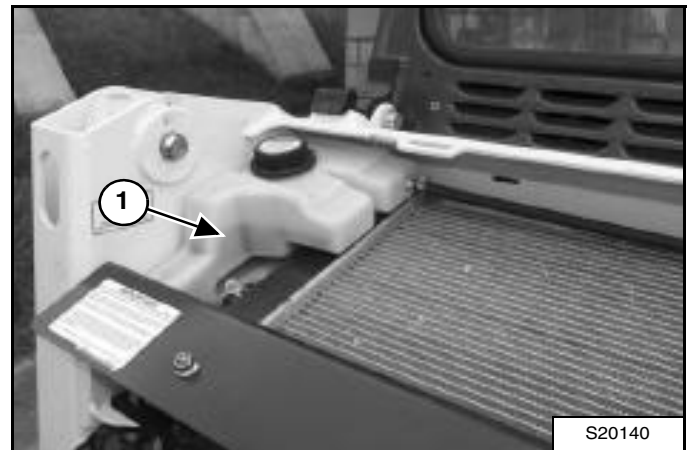

Check coolant level using the level markers (Item 1) [Figure 187] on the tank. Coolant must be between the top and bottom markers when the engine is cold.

Install the rear grille and close the rear door.

ENGINE COOLING SYSTEM (CONT'D)

Removing And Replacing Coolant

Open the rear door. (See REAR DOOR (TAILGATE) on Page 117.)

Remove the rear grille. (See REAR GRILLE on Page 117.)

Figure 188

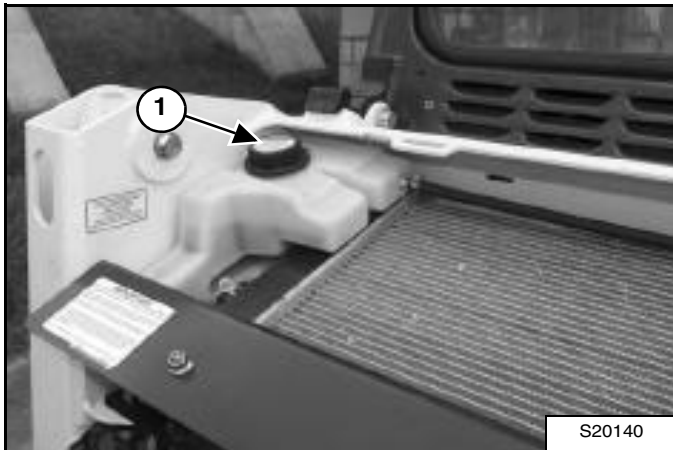

Remove the coolant fill cap (Item 1) [Figure 188].

Figure 189

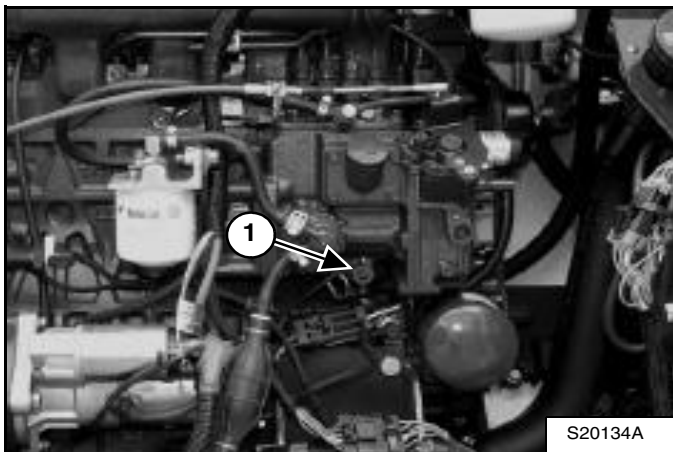

Connect a hose to the engine block drain valve (Item 1) [Figure 189]. Open the drain valve and drain the coolant into a container.

After all the coolant is removed, close the drain valve and remove the hose.

NOTE: Fluids such as engine oil, hydraulic fluid, coolant, etc. must be disposed of in an environmentally safe manner. Some regulations require that certain spills and leaks on the ground must be cleaned in a specific manner. See local bylaws for correct disposal.

Mix new coolant in a separate container. (See Capacities on Page 168.)

NOTE: The loader is factory filled with propylene glycol coolant (purple colour). **DO NOT** mix propylene glycol with ethylene glycol.

Add premixed coolant, 47% water and 53% propylene glycol to the recovery tank. (See Checking Level on Page 126.)

IMPORTANT

AVOID ENGINE DAMAGE

Always use the correct ratio of water to antifreeze.

Too much antifreeze reduces cooling system efficiency and may cause serious premature engine damage.

Too little antifreeze reduces the additives which protect the internal engine components; reduces the boiling point and freeze protection of the system.

Always add a premixed solution. Adding full strength concentrated coolant can cause serious premature engine damage.

I-2124-0497

The correct mixture of coolant to provide a -37°C (-34°F) freeze protection is 5 L propylene glycol mixed with 4,4 L of water **OR** 1 U.S. gal propylene glycol mixed with 3.5 qt of water.

Fill the tank until it is between the top and bottom markers on the tank.

Use a refractometer to check the condition of propylene glycol in the cooling system and replace coolant fill cap.

NOTE: When installing the coolant fill cap, the cap must be tightened until it clicks.

Run the engine until it is at operating temperature. Stop the engine. Check the coolant level when cool. Add coolant as needed.

Install the rear grille and close the rear door.

ELECTRICAL SYSTEM

Description

Figure 190

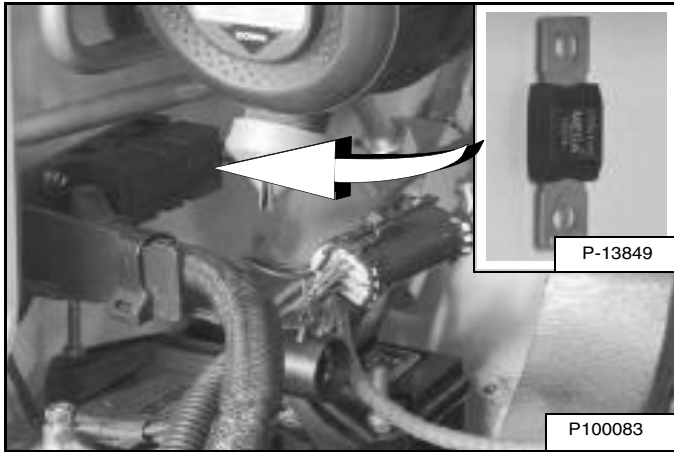

The loader has a 12 volt, negative earth alternator charging system. The electrical system is protected by fuses located in the engine compartment and a 100 ampere master fuse (Inset) [Figure 190] located under the air cleaner. The fuses will protect the electrical system when there is an electrical overload. The reason for the overload must be found before starting the engine again.

Fuse And Relay Location / Identification

Figure 191

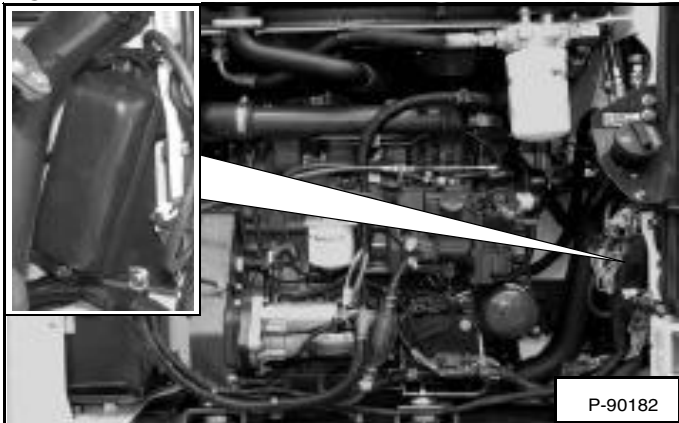

The electrical system is protected from overload by fuses and relays under the fuse panel cover (Inset) [Figure 191]. A decal is inside the cover to show location and amperage ratings.

Remove the cover to check or replace the fuses.

Figure 192

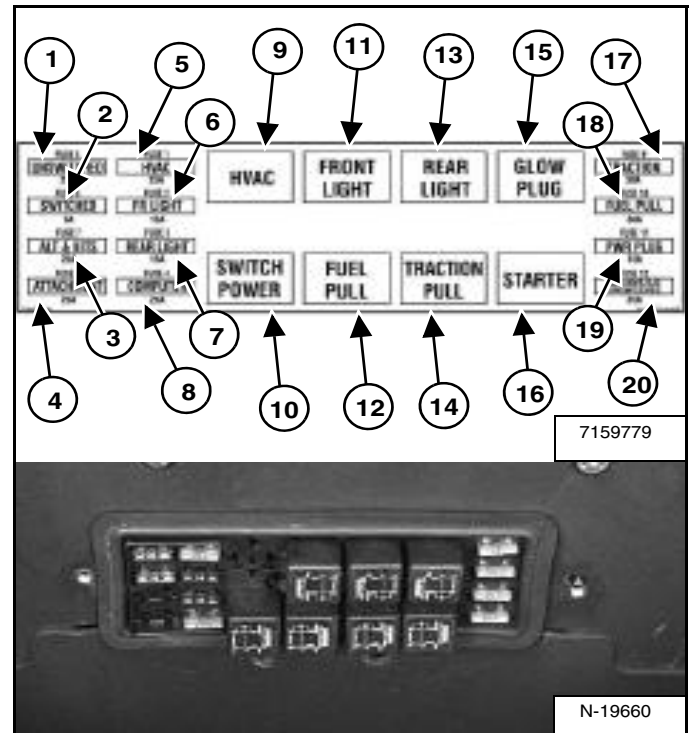

The location and sizes are shown below and [Figure 192].

REF	DESCRIPTION	AMP	REF	DESCRIPTION	AMP
1	Unswitched Horn	25	11	Front & Marker Lights	R
2	ACS/AWS/SJC Switched	5	12	Fuel Shutoff	R
3	Alternator & Accessories Back-up Alarm	25	13	Rear Lights	R
4	Attachments	25	14	Traction	R
5	Heater & Air Conditioning	25	15	Glow Plugs	R
6	Front & Marker Lights	15	16	Starter	R
7	Rear Lights	15	17	Traction	30
8	Bobcat Controller	25	18	Fuel Shutoff	30
9	Heater & Air Conditioning	R	19	Power Plug	15
10	Switch Power	R	20	ACS/AWS/SJC Unswitched	25

R - Relay

ELECTRICAL SYSTEM (CONT'D)

Battery Maintenance

Figure 193

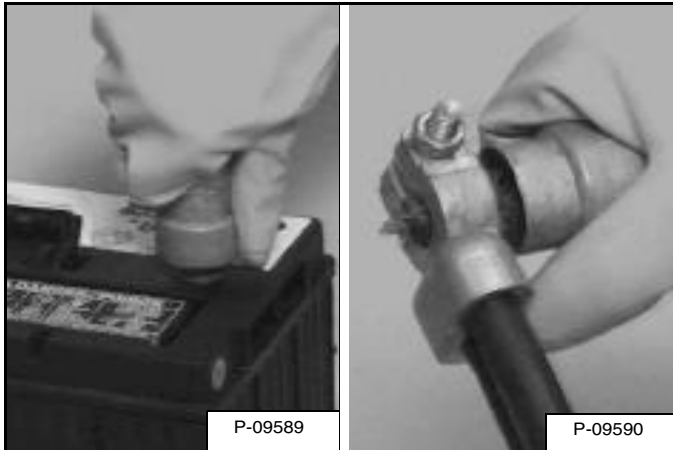

The battery cables must be clean and tight **[Figure 193]**. Check electrolyte level in the battery. Add distilled water as needed. Remove acid or corrosion from battery and cables with sodium bicarbonate (baking soda) and water solution.

Put Battery Saver (6988074) or grease on the battery terminals and cable ends to prevent corrosion.

! WARNING

AVOID INJURY OR DEATH

Batteries contain acid which burns eyes and skin on contact. Wear goggles, protective clothing and rubber gloves to keep acid off body.

In case of acid contact, wash immediately with water. In case of eye contact get prompt medical attention and wash eye with clean, cool water for at least 15 minutes.

If electrolyte is taken internally drink large quantities of water or milk! **DO NOT** induce vomiting. Get prompt medical attention.

W-2065-0807

ELECTRICAL SYSTEM (CONT'D)

Using A Booster Battery (Jump Starting)

If it is necessary to use a booster battery to start the engine, BE CAREFUL! There must be one person in the operator's seat and one person to connect and disconnect the battery cables.

The key switch must be OFF or the STOP button must be pressed. The booster battery must be 12 volt.

! WARNING

BATTERY GAS CAN EXPLODE AND CAUSE SERIOUS INJURY OR DEATH

Keep arcs, sparks, flames and lighted tobacco away from batteries. When *jumping* from booster battery make final connection (negative) at machine frame.

Do not jump start or charge a frozen or damaged battery. Warm battery to 16°C (60°F) before connecting to a charger. Unplug charger before connecting or disconnecting cables to battery. Never lean over battery while boosting, testing or charging.

W-2066-0910

Figure 194

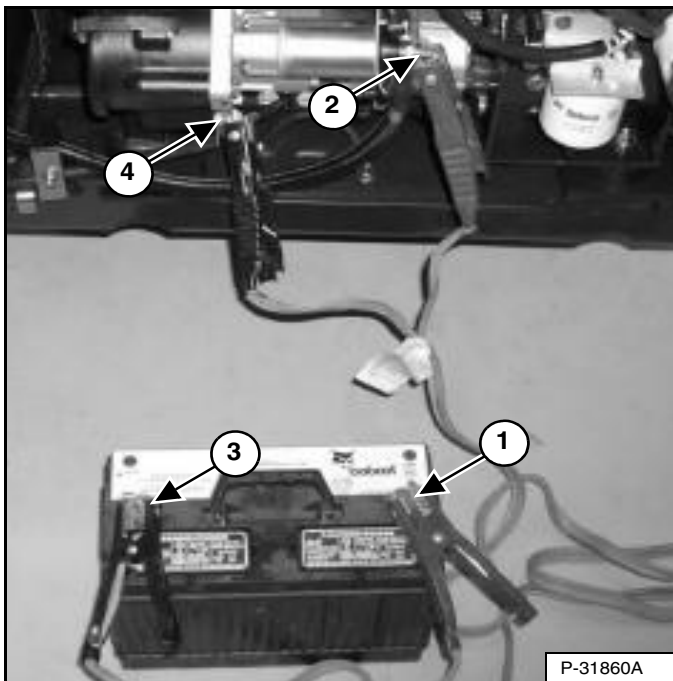

P-31860A

Connect the end of the first cable (Item 1) [Figure 194] to the positive (+) terminal of the booster battery. Connect the other end of the same cable (Item 2) [Figure 194] to the positive terminal on the loader starter.

Connect the end of the second cable (Item 3) [Figure 194] to the negative terminal of the booster battery. Connect the other end of the same cable (Item 4) [Figure 194] to the engine.

Keep cables away from moving parts. Start the engine. (See STARTING THE ENGINE on Page 71.)

After the engine has started, remove the earth (-) cable (Item 4) [Figure 194] first. Remove the cable from the positive terminal (Item 2) [Figure 194].

IMPORTANT

Damage to the alternator can occur if:

- Engine is operated with battery cables disconnected.
- Battery cables are connected when using a fast charger or when welding on the loader. (Remove both cables from the battery.)
- Extra battery cables (booster cables) are connected wrong.

I-2023-1285

ELECTRICAL SYSTEM (CONT'D)

Removing And Installing Battery



AVOID INJURY OR DEATH

Batteries contain acid which burns eyes and skin on contact. Wear goggles, protective clothing and rubber gloves to keep acid off body.

In case of acid contact, wash immediately with water. In case of eye contact get prompt medical attention and wash eye with clean, cool water for at least 15 minutes.

If electrolyte is taken internally drink large quantities of water or milk! DO NOT induce vomiting. Get prompt medical attention.

W-2065-0807

Open the rear door. (See REAR DOOR (TAILGATE) on Page 117.)

Figure 195

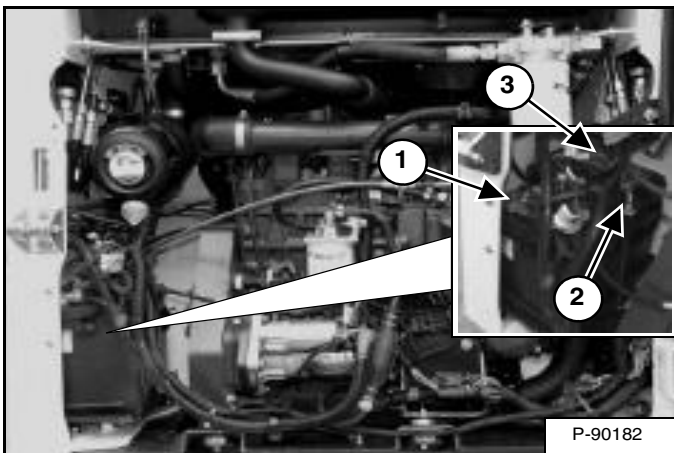

Disconnect the negative (-) cable (Item 1) [Figure 195].

Remove the battery hold down clamp (Item 2) [Figure 195].

Disconnect the positive (+) cable (Item 3) [Figure 195] from the battery.

Remove the battery from the loader.

Figure 196

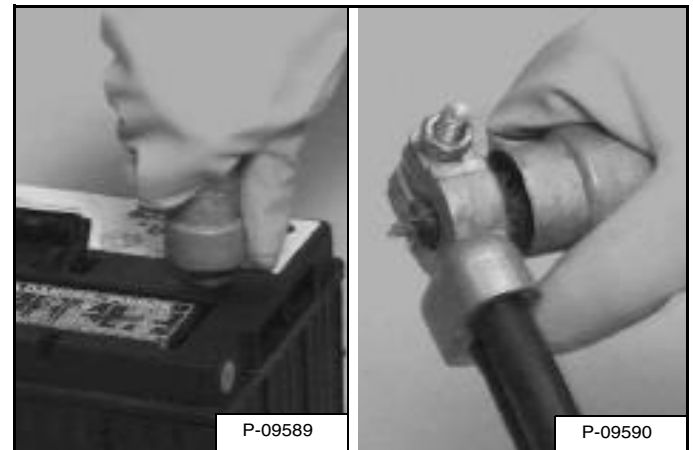

Always clean the battery terminals and cable ends when installing a new or used battery [Figure 196].

When installing the battery in the loader, do not touch any metal parts with the battery terminals.

Connect the negative (-) cable last to prevent sparks.

Connect and tighten the battery cables.

Install and tighten the battery hold down.

Close the rear door.



BATTERY GAS CAN EXPLODE AND CAUSE SERIOUS INJURY OR DEATH

Keep arcs, sparks, flames and lighted tobacco away from batteries. When *jumping* from booster battery make final connection (negative) at machine frame.

Do not jump start or charge a frozen or damaged battery. Warm battery to 16°C (60°F) before connecting to a charger. Unplug charger before connecting or disconnecting cables to battery. Never lean over battery while boosting, testing or charging.

W-2066-0910

HYDRAULIC / HYDROSTATIC SYSTEM

Checking And Adding Fluid

Check the hydraulic / hydrostatic fluid level every day before starting the work shift.

Park the loader on a level surface, lower the lift arms and tilt the Bob-Tach fully back.

Stop the engine.

Figure 197

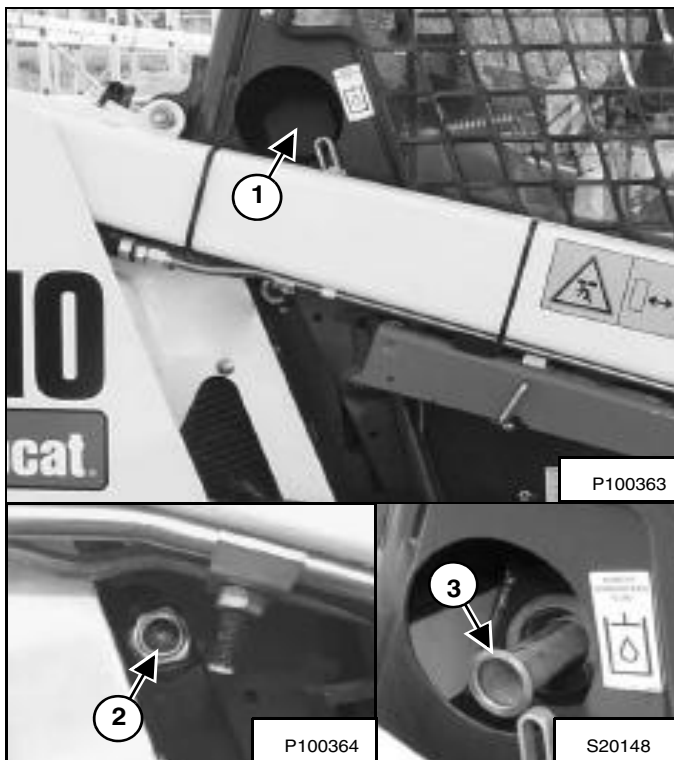

Remove the fill cap (Item 1) [Figure 197].

Add fluid as needed to bring the level to the middle of the sight gauge (Item 2) [Figure 197]. Do not overfill.

Remove the screen (Item 3) [Figure 197] and clean with solvent as needed.

Install the fill cap (Item 1) [Figure 197].

Hydraulic / Hydrostatic Fluid Chart

Figure 198
HYDRAULIC / HYDROSTATIC FLUID
RECOMMENDED ISO VISCOSITY GRADE (VG)
AND VISCOSITY INDEX (VI)

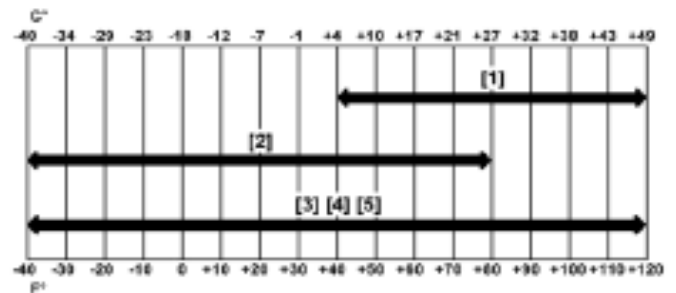

TEMPERATURE RANGE ANTICIPATED DURING MACHINE USE

- [1] VG 100; Minimum VI 130
- [2] VG 46; Minimum VI 150
- [3] BOBCAT All-Season Fluid
- [4] BOBCAT Synthetic Fluid
- [5] BOBCAT Biodegradable Hydraulic / Hydrostatic Fluid (Unlike biodegradable fluids that are vegetable based, Bobcat biodegradable fluid is formulated to prevent oxidation and thermal breakdown at operating temperatures.)

Use only recommended fluid in the hydraulic system [Figure 198].

HYDRAULIC / HYDROSTATIC SYSTEM (CONT'D)

Removing And Replacing Hydraulic Fluid

For the correct service interval (See SERVICE SCHEDULE on Page 105.)

Replace the fluid if it becomes contaminated or after major repair.

Always replace the hydraulic / hydrostatic filter, the case drain filters and the hydraulic charge filter whenever the hydraulic fluid is replaced. (See Removing And Replacing Hydraulic / Hydrostatic Filter on Page 134.)

Figure 199

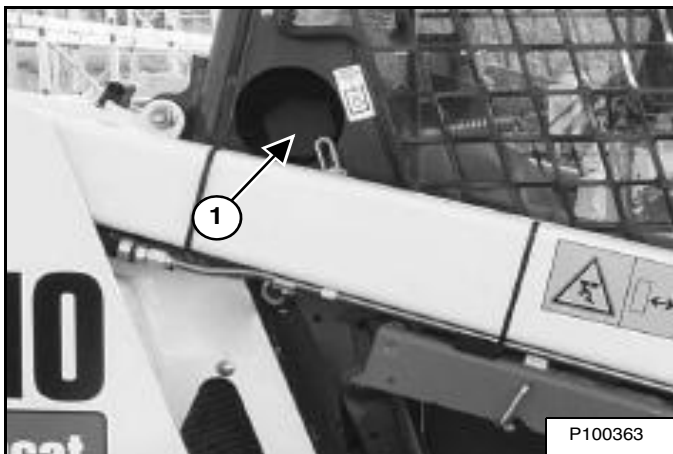

Remove the fill cap (Item 1) [Figure 199].

Raise the operator cab. (See Raising on Page 114.)

Figure 200

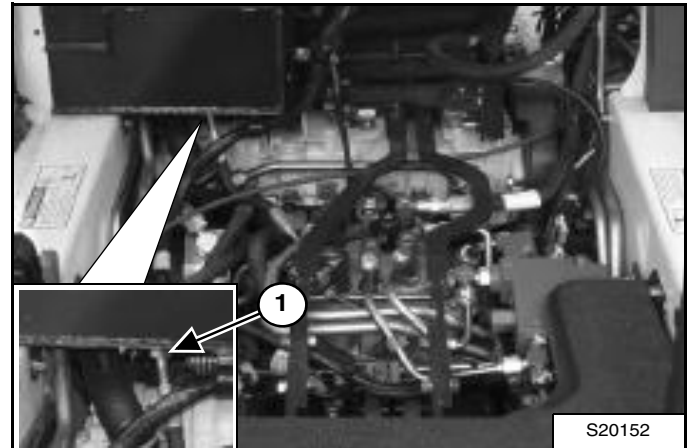

Disconnect the hose (Item 1) [Figure 200] from the hydraulic reservoir and drain the fluid into a container.

Reconnect the hose when reservoir is empty.

Recycle or dispose of used fluid in an environmentally safe manner.

WARNING

AVOID INJURY OR DEATH

Always clean up spilled fuel or oil. Keep heat, flames, sparks or lighted tobacco away from fuel and oil. Failure to use care around combustibles can cause explosion or fire.

W-2103-0508

Lower the operator cab. (See Lowering on Page 115.)

Add the correct fluid to the reservoir until the fluid level is at the centre of the sight gauge. (See Checking And Adding Fluid on Page 132.)

HYDRAULIC / HYDROSTATIC SYSTEM (CONT'D)

Removing And Replacing Hydraulic / Hydrostatic Filter

For the correct service interval (See SERVICE SCHEDULE on Page 105.)

Open the rear door. (See REAR DOOR (TAILGATE) on Page 117.)

Figure 201

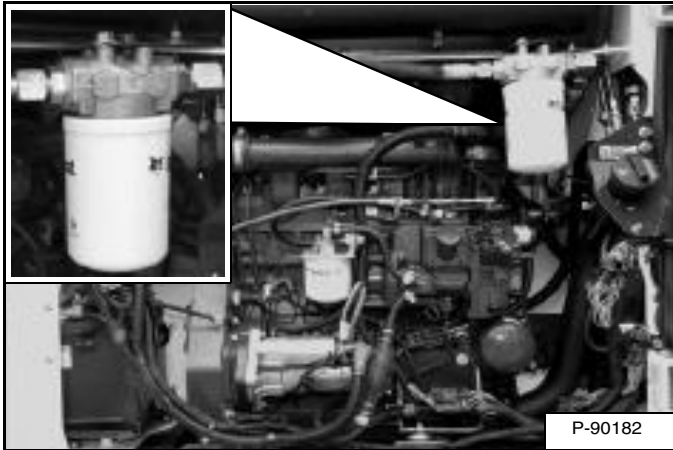

Remove the filter (Inset) [Figure 201].

Clean the surface of the filter housing where the filter seal contacts the housing.

Put clean oil on the seal of the new filter element. Install and hand tighten the filter element.

! WARNING

AVOID INJURY OR DEATH

Always clean up spilled fuel or oil. Keep heat, flames, sparks or lighted tobacco away from fuel and oil. Failure to use care around combustibles can cause explosion or fire.

W-2103-0508

Close the rear door.

Start the engine and operate the loader hydraulic controls.

Stop the engine and check for leaks at the filter.

Check the fluid level in the reservoir and add as needed. (See Checking And Adding Fluid on Page 132.)

Removing And Replacing Case Drain Filters

For the correct service interval (See SERVICE SCHEDULE on Page 105.)

Raise the operator cab. (See Raising on Page 114.)

Figure 202

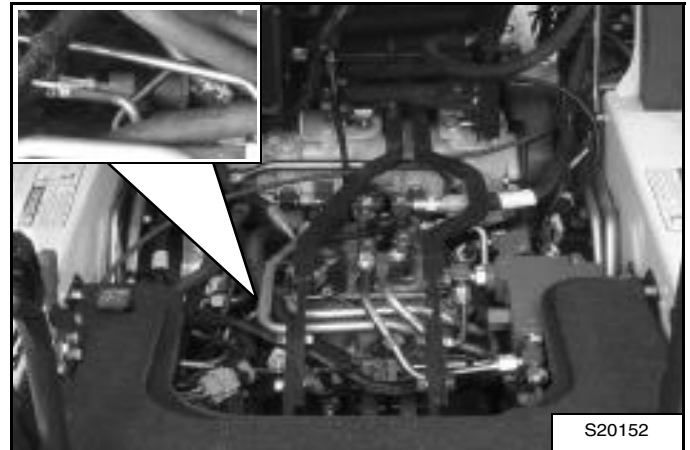

Disconnect the hoses and fittings at the ends of both case drain filters (Inset) [Figure 202].

Remove the mounting clamp from the filters.

Install fittings on new filters.

Install new filters, install mounting clamp.

Reconnect and tighten hoses.

! WARNING

AVOID INJURY OR DEATH

Always clean up spilled fuel or oil. Keep heat, flames, sparks or lighted tobacco away from fuel and oil. Failure to use care around combustibles can cause explosion or fire.

W-2103-0508

Lower the operator cab. (See Lowering on Page 115.)

Start the engine and operate the loader hydraulic controls. Stop the engine and check for leaks.

Check the fluid level in the reservoir and add as needed. (See Checking And Adding Fluid on Page 132.)

HYDRAULIC / HYDROSTATIC SYSTEM (CONT'D)

Removing And Replacing Hydraulic Charge Filter

The hydraulic charge filter is located under the cab. For the correct service interval (See SERVICE SCHEDULE on Page 105.)

NOTE: SJC equipped machines do not have a Hydraulic Charge Filter.

Raise the operator cab. (See Raising on Page 114.)

Figure 203

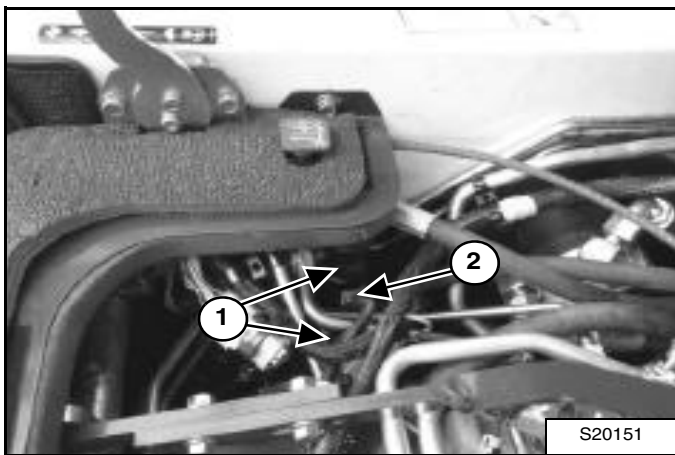

Disconnect the hoses (Item 1) and remove the filter (Item 2) [Figure 203].

Install new filter.

Connect and tighten hoses.



AVOID INJURY OR DEATH

Always clean up spilled fuel or oil. Keep heat, flames, sparks or lighted tobacco away from fuel and oil. Failure to use care around combustibles can cause explosion or fire.

W-2103-0508

Lower the operator cab. (See Lowering on Page 115.)

Start the engine and operate the loader hydraulic controls.



AVOID INJURY OR DEATH

Diesel fuel or hydraulic fluid under pressure can penetrate skin or eyes, causing serious injury or death. Fluid leaks under pressure may not be visible. Use a piece of cardboard or wood to find leaks. Do not use your bare hand. Wear safety goggles. If fluid enters skin or eyes, get immediate medical attention from a physician familiar with this injury.

W-2072-0807

Stop the engine and check for leaks at the filter.

Check the fluid level in the reservoir and add as needed. (See Checking And Adding Fluid on Page 132.)

Breather Cap

See the SERVICE SCHEDULE for the correct replacement interval. (See SERVICE SCHEDULE on Page 105.)

Figure 204



Remove and discard the hydraulic breather (Item 1) [Figure 204].

Install new breather.

SPARK ARRESTER MUFFLER

Cleaning Procedure

See the SERVICE SCHEDULE for service interval for cleaning the spark arrester muffler. (See SERVICE SCHEDULE on Page 105.)

Do not operate the loader with a defective exhaust system.

IMPORTANT

This machine is factory equipped with a spark arrester exhaust system.

The spark arrester muffler, if equipped, must be cleaned to keep it in working condition. The spark arrester muffler must be serviced by dumping the spark chamber every 100 hours of operation.

On some models, the turbocharger functions as the spark arrester and must operate correctly for proper spark arrester function.

If this machine is operated on flammable forest, brush, or grass covered land, a spark arrester attached to the exhaust system may be required and must be maintained in working order. Refer to local laws and regulations for spark arrester requirements.

I-2284-EN-0909

Stop the engine. Open the rear door.

Figure 205

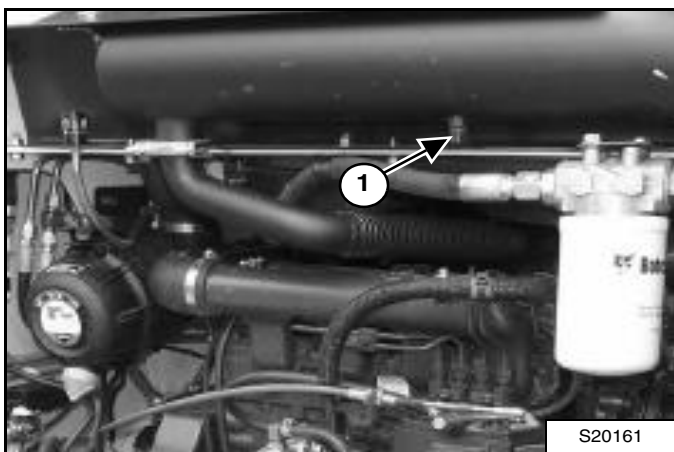

Remove the plug (Item 1) [Figure 205] from the bottom of the muffler.

! WARNING

When the engine is running during service, the driving and steering controls must be in neutral and the parking brake engaged. Failure to do so can cause injury or death.

W-2006-1209

Start the engine and run for about 10 seconds while a second person, wearing safety glasses, holds a piece of wood over the outlet of the muffler.

This will force contaminants out through the cleanout hole.

Stop the engine.

Install and tighten the plug.

Close the rear door.

! WARNING

AVOID INJURY OR DEATH

When an engine is running in an enclosed area, fresh air must be added to avoid concentration of exhaust fumes. If the engine is stationary, vent the exhaust outside. Exhaust fumes contain odorless, invisible gases which can kill without warning.

W-2050-0807

! WARNING

Stop engine and allow the muffler to cool before cleaning the spark chamber. Wear safety goggles. Failure to obey can cause serious injury.

W-2011-1285

! WARNING

Never use machine in atmosphere with explosive dust or gases or where exhaust can contact flammable material. Failure to obey warnings can cause injury or death.

W-2068-1285

TRACK TENSION

Description

Correct track tension is important for good performance and to prevent the tracks from derailing or wearing prematurely.

NOTE: The wear of track rollers vary with the working conditions and different types of soil conditions.

Figure 206



The MEL1560 - Bleed Tool [Figure 206] is required to decrease track tension.

Checking

Park the loader on a level surface.

Figure 207

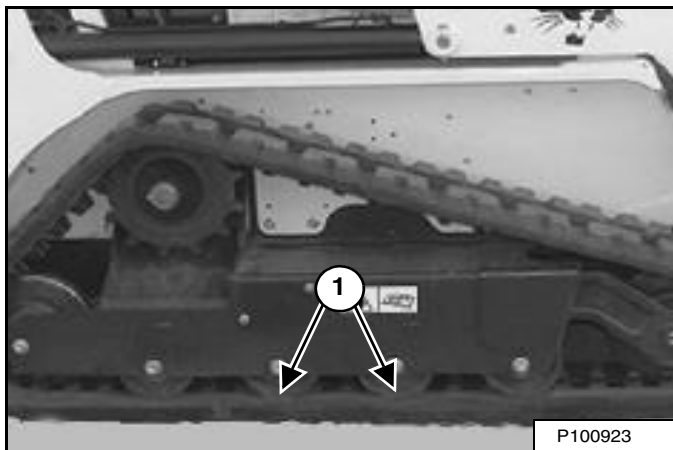

Raise one side of the loader and put jackstands at the front and rear of the loader frame so that the track is about 76 mm (3 in) off the ground [Figure 207]. Lower the loader to the jackstands. Be sure the jackstands do not touch the tracks.

Measure the track sag at either middle track roller (Item 1) [Figure 207]. The correct gap is 13 mm (1/2 in).

Figure 208

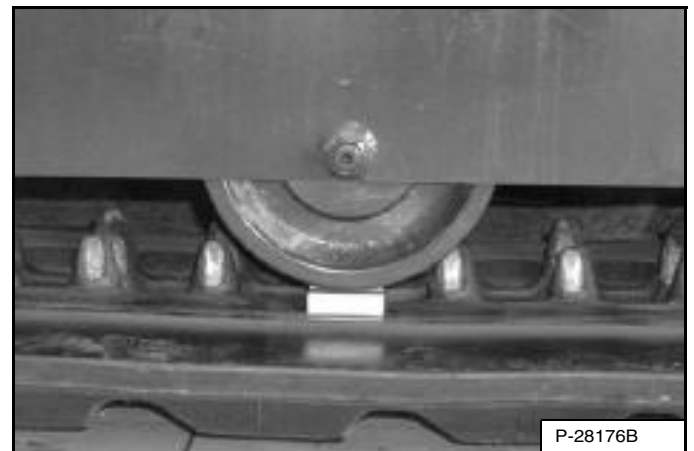
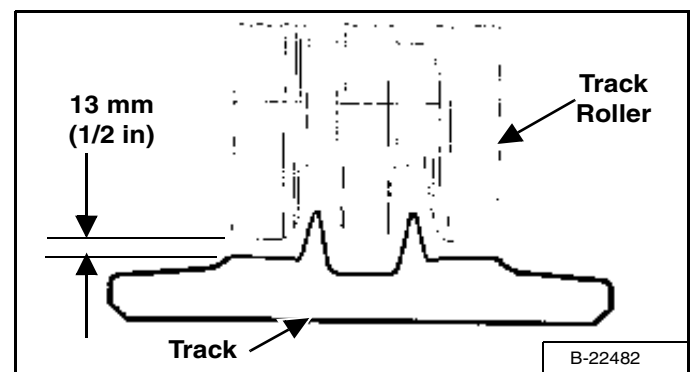

Figure 209



DO NOT put your fingers into the pinch points between the track and the roller. Use a 13 mm (1/2 in) bolt, dowel or block to check the gap [Figure 208] and [Figure 209].

! WARNING

AVOID INJURY

Keep fingers and hands out of pinch points when checking the track tension.

W-2142-0903

TRACK TENSION (CONT'D)

Adjusting

Figure 210

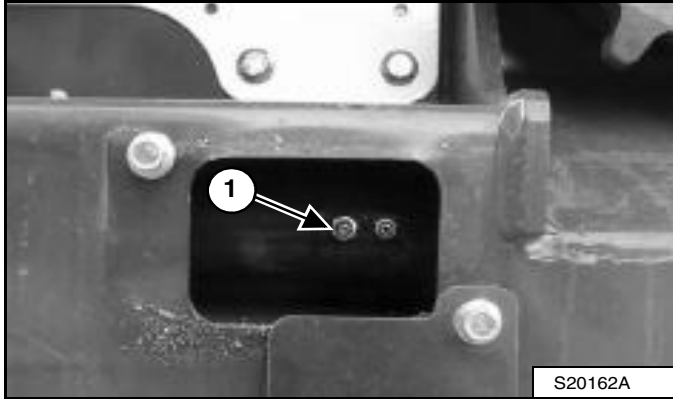

Loosen the cover bolts and turn the access cover down [Figure 210].

Increase Track Tension

Add grease to the grease fitting (Item 1) [Figure 210] until the track adjustment is correct [Figure 208] and [Figure 209]. (Left side shown.)

NOTE: Do not remove grease fitting unless pressure is released using the bleed fitting. (See Figure 211 on Page 138.)

NOTE: If replacement is necessary, always replace grease fitting (Item 1) [Figure 210] with genuine Bobcat Parts. The grease fitting is a special fitting designed for high pressure.

Decrease Track Tension



**HIGH PRESSURE GREASE CAN
CAUSE SERIOUS INJURY**

- Do not loosen grease fitting.
- Do not loosen bleed fitting more than 1 - 1/2 turns.

W-2781-0109

Figure 211

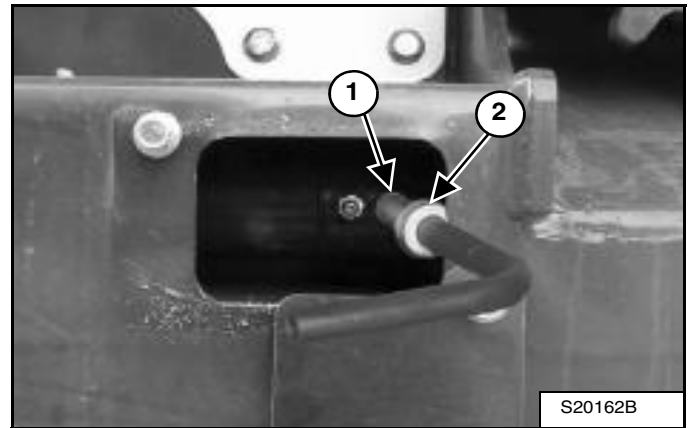

Pressure must be released from the grease cylinder to decrease track tension.

Install the bleed tool (MEL1560) on the bleed fitting (Item 1), adjust and tighten the collar (Item 2) [Figure 211] to fit behind the edge of the access cover hole.

Figure 212

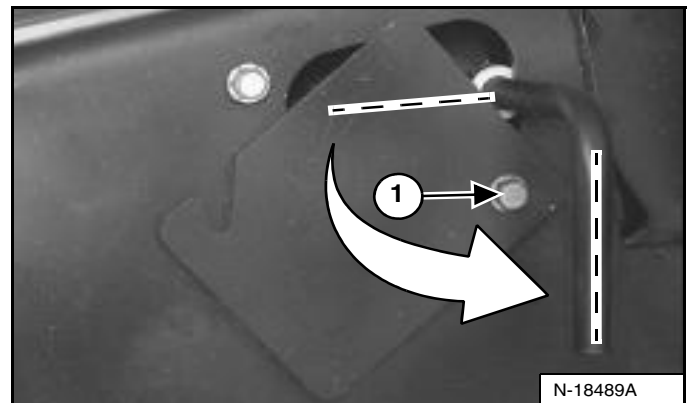

Tighten the cover bolt (Item 1) [Figure 212] to secure the tool.

Turn the tool 1/4 turn anticlockwise and let the grease flow into a container. Release pressure [Figure 212] until the track adjustment is correct [Figure 208] and [Figure 209].

Tighten the bleed fitting. Pivot the access cover closed and tighten the access cover bolts.

Raise the loader and remove the jackstands.

Repeat the procedure for the other track.

Dispose of grease in an environmentally safe manner.

HYDROSTATIC DRIVE MOTOR

Removing And Replacing Oil

The hydrostatic drive motors require no maintenance.

See your Bobcat dealer for track replacement.

TRACK SPROCKET MAINTENANCE

Tightening Procedure

For the correct service interval (See SERVICE SCHEDULE on Page 105.)

Figure 213

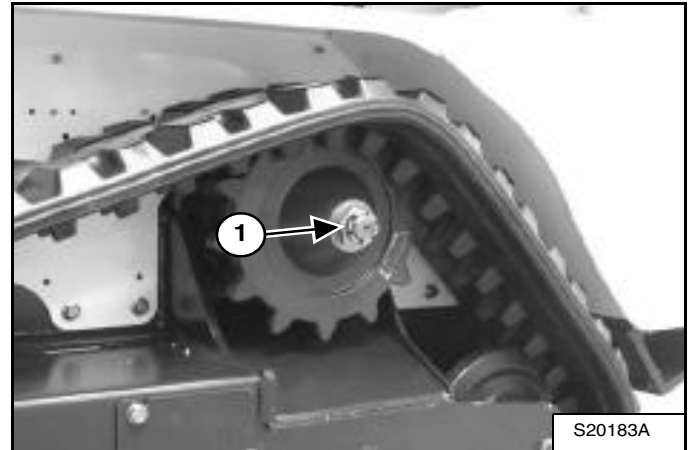

Check the torque of the track sprocket nuts (Item 1) [Figure 213]. Tighten the nuts to 550 N•m (406 ft-lb) torque.

ALTERNATOR BELT

Belt Adjustment

Stop the engine.

Open the rear door. (See REAR DOOR (TAILGATE) on Page 117.)

Figure 214

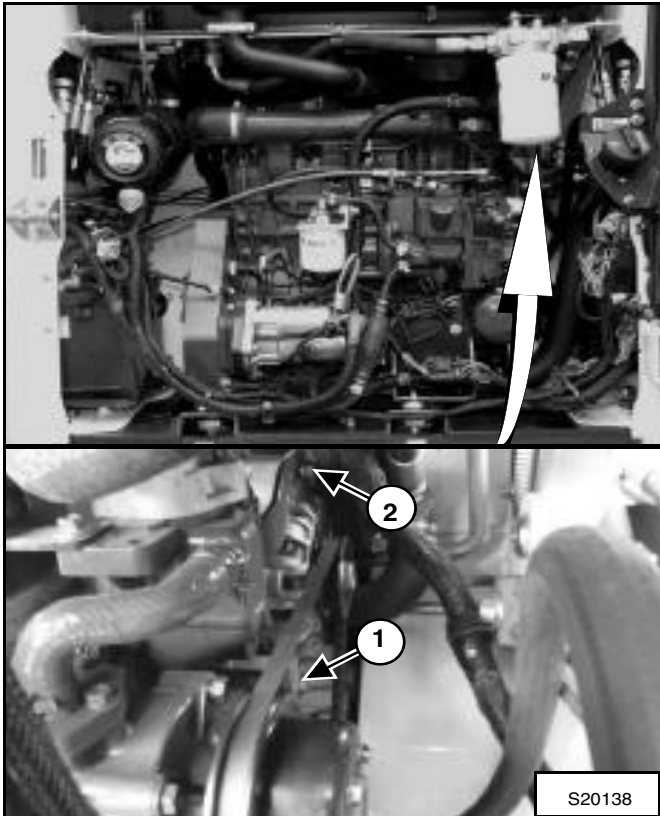

Loosen the alternator mounting bolt (Item 1) [Figure 214].

Loosen the adjustment bolt (Item 2) [Figure 214].

Move the alternator until the belt has 2,14 mm (0.09 in) movement at the middle of the belt span between the crankshaft pulley and the water pump pulley with 11,9 - 12,8 N (2.67 - 2.87 lb) of force.

The measured frequency of a properly tensioned belt in this span is 152 - 158 Hz.

Tighten the adjustment and mounting bolts.

Close the rear door.

Belt Replacement

Stop the engine.

Open the rear door. (See REAR DOOR (TAILGATE) on Page 117.)

Loosen the alternator mounting and adjustment bolts (Items 1 and 2) [Figure 214] and loosen the belt all the way.

Remove the belt and install a new belt.

Move the alternator until the belt has 2,14 mm (0.09 in) movement at the middle of the belt span between the crankshaft pulley and the water pump pulley with 10,3 - 11,1 N (2.31 - 2.495 lb) of force.

The measured frequency of a properly tensioned belt in this span is 141 - 147 Hz.

Tighten the adjustment and mounting bolts.

Close the rear door.

DRIVE BELT

Belt Adjustment

Drive belt tension is automatically maintained, no adjustment is necessary.

Belt Replacement

Stop the engine.

Open the rear door. (See REAR DOOR (TAILGATE) on Page 117.)

Disconnect the negative (-) battery cable.

Remove the drive belt shield fasteners and remove the drive belt shield.

Figure 215

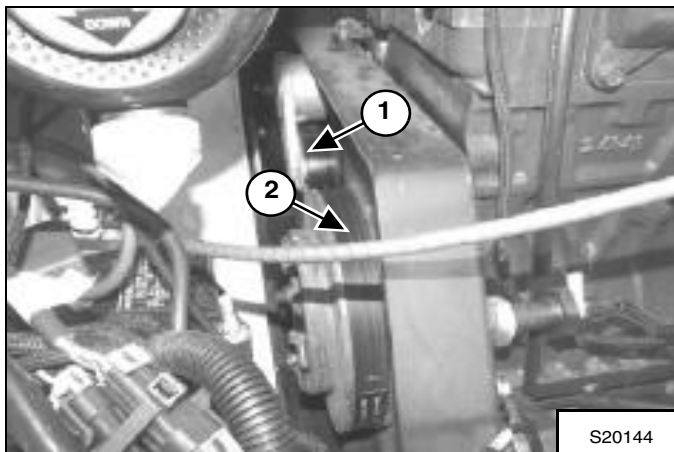

Loosen the drive belt (Item 2) by pulling the tension wheel (Item 1) [Figure 215] upwards with a socket wrench.

Remove the drive belt.

Install new drive belt.

Lower the tension wheel onto the drive belt.

Install the drive belt shield and drive belt shield fasteners.

Connect the negative (-) battery cable.

Close the rear door.

LUBRICATING THE LOADER

Lubrication Locations

Lubricate the loader as specified for the best performance of the loader. (See SERVICE SCHEDULE on Page 105.).

Record the operating hours each time you lubricate the Bobcat Loader.

Always use a good quality lithium based multipurpose grease when you lubricate the loader. Apply the lubricant until extra grease shows.

Lubricate the following locations on the loader:

Figure 216

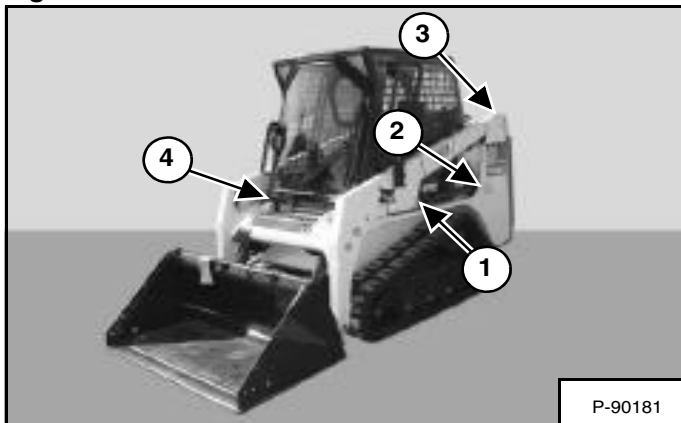
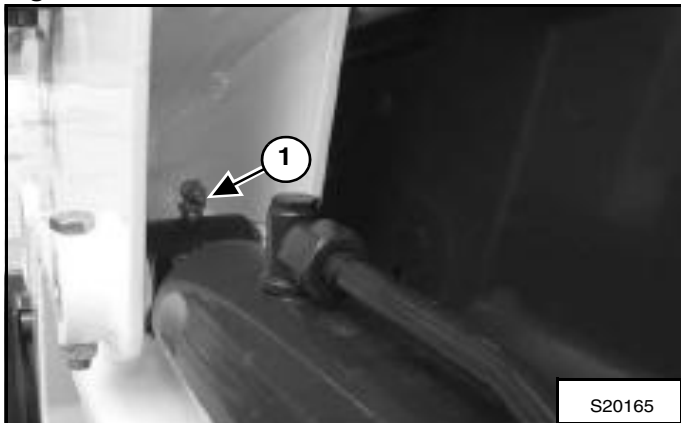
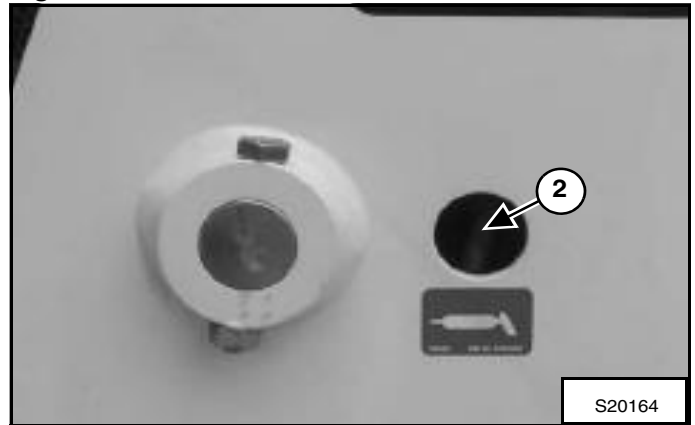

Figure 217



1. Rod End Lift Cylinder (Both Sides) (2) [Figure 216] and [Figure 217].

Figure 218



2. Base End Lift Cylinder (Both Sides) (2) [Figure 216] and [Figure 218].

Figure 219

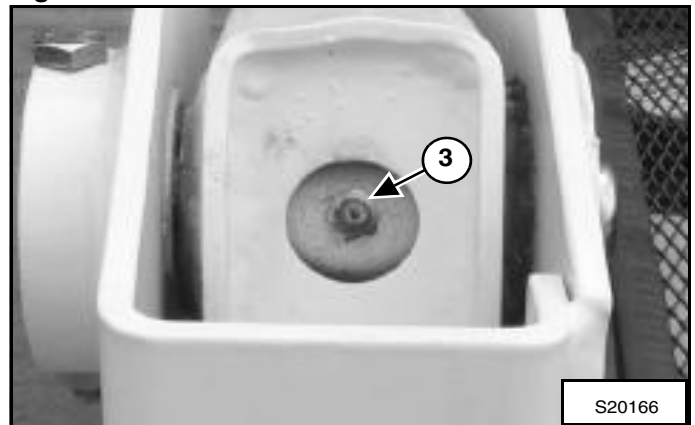

3. Lift Arm Pivot Pin (Both Sides) (2) [Figure 216] and [Figure 219].

LUBRICATING THE LOADER (CONT'D)

Lubrication Locations (Cont'd)

Figure 220

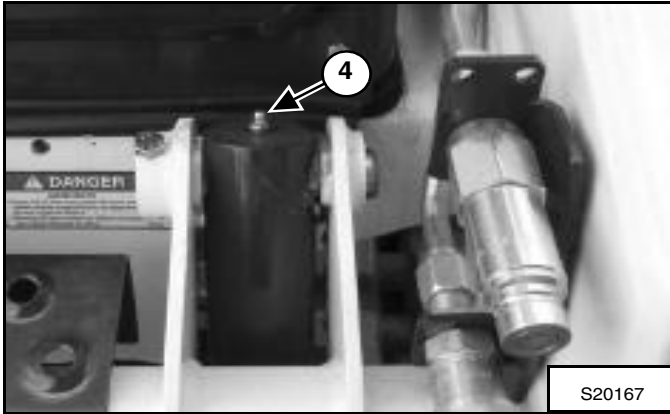

4. Base End Tilt Cylinder (Both Sides) (2) [Figure 216] and [Figure 220].

Figure 221

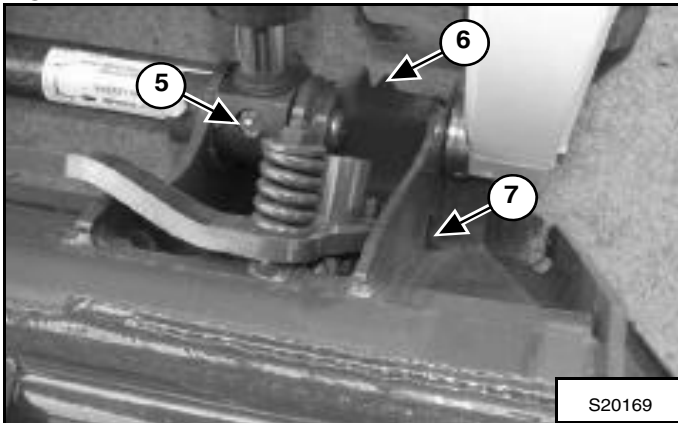

5. Rod End Tilt Cylinder (Both Sides) (2) [Figure 221].
6. Bob-Tach Pivot Pin (Both Sides) (2) [Figure 221].
7. Bob-Tach Wedge (Both Sides) (2) [Figure 221].

Figure 222

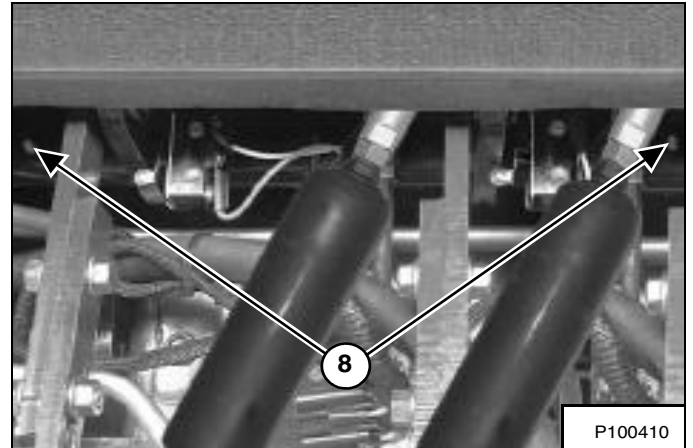

8. 250 Hours: Steering Lever Shaft (2) under the operator cab [Figure 222].

TRACK ROLLER AND IDLER LUBRICATION

Procedure

The track rollers and idlers have sealed bearings and do not require lubrication.

PIVOT PINS

Inspection And Maintenance

Figure 223

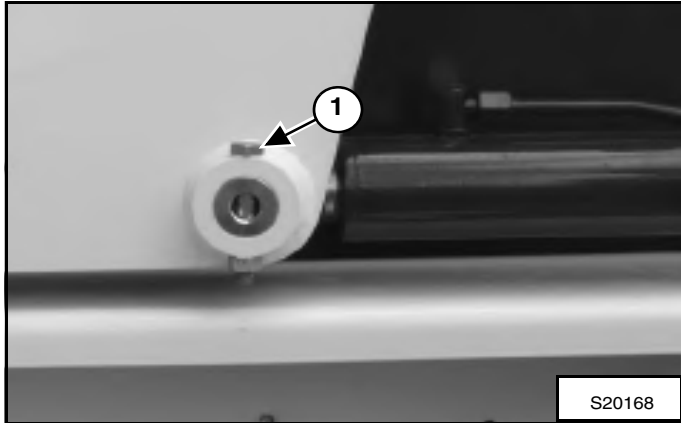

All lift arm and cylinder pivots have a large pin held in position with a retainer bolt and lock nut (Item 1) [Figure 223].

Figure 224

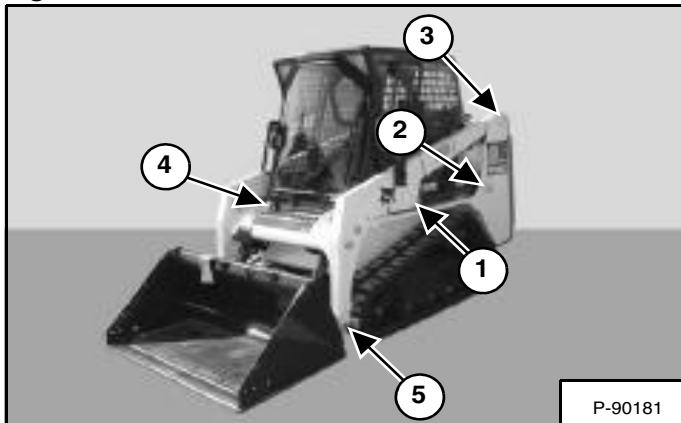
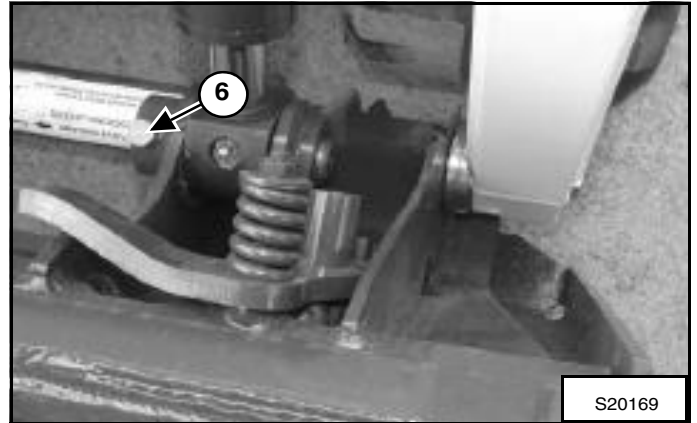

Figure 225



Check that the lock nuts are tightened to 48 - 54 N•m (35 - 40 ft-lb) torque (Both Sides) (Items 1 - 6) [Figure 224] and [Figure 225].

BOB-TACH (HAND LEVER)

Inspection And Maintenance

Figure 226

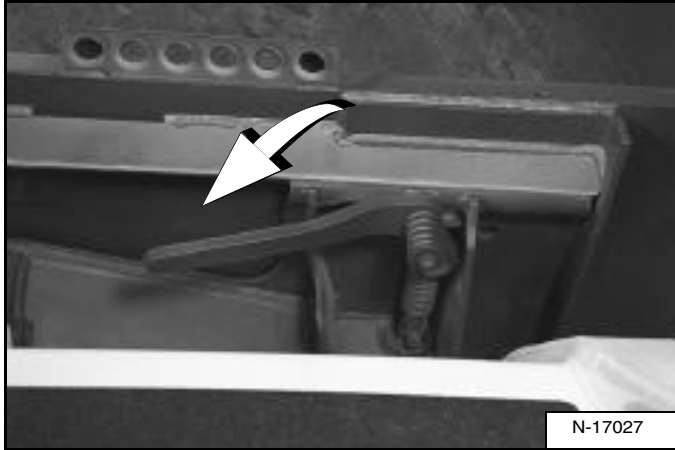

Move the Bob-Tach levers down to engage the wedges [Figure 226].

The levers and wedges must move freely.

! WARNING

AVOID INJURY OR DEATH

The Bob-Tach wedges must extend through the holes in the attachment mounting frame. Levers must be fully down and locked. Failure to secure wedges can allow attachment to come off.

W-2715-0208

Figure 227

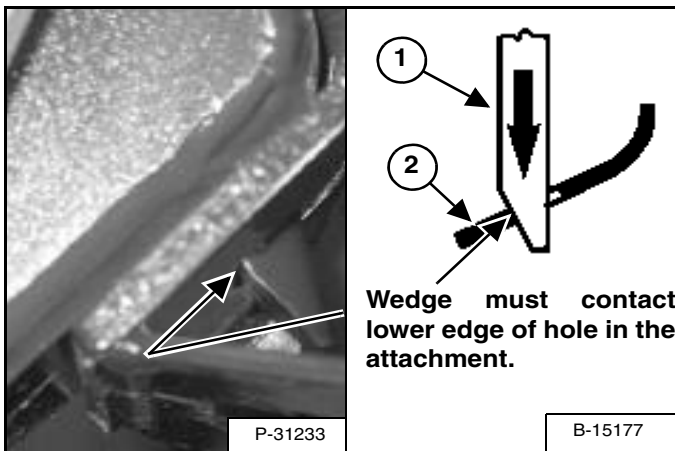

The wedges (Item 1) [Figure 227] must extend through the holes in the attachment mounting frame.

The spring loaded wedge (Item 1) must contact the lower edge of the hole in the attachment (Item 2) [Figure 227].

If the wedge does not contact the lower edge of the hole [Figure 227], the attachment will be loose and can come off the Bob-Tach.

Figure 228

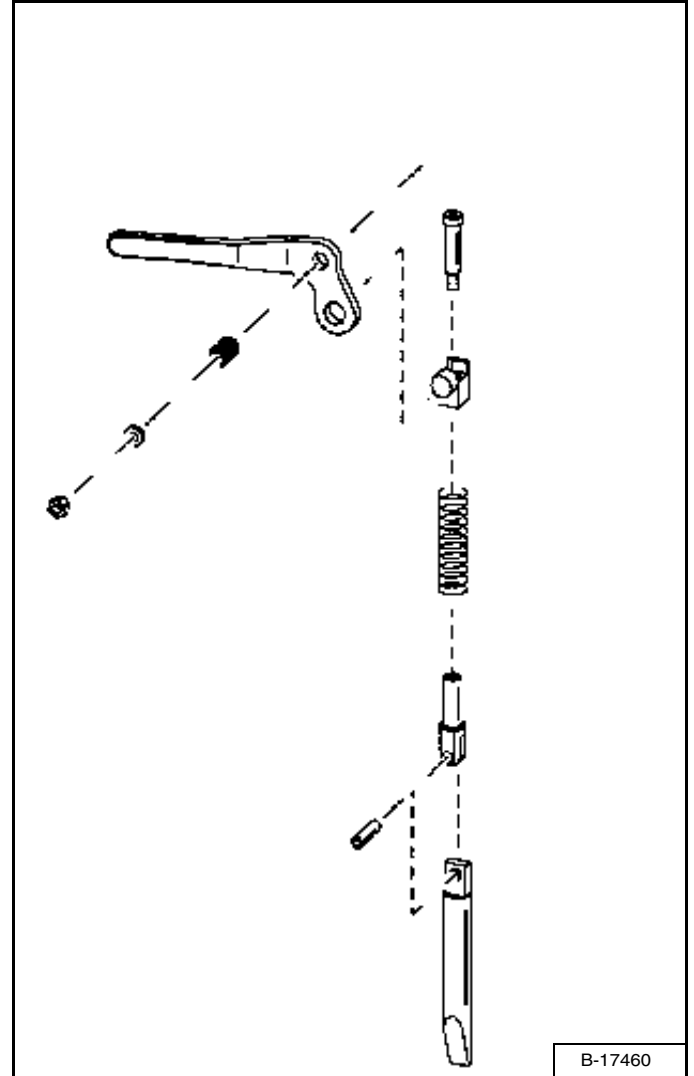

Inspect the mounting frame on the attachment and Bob-Tach, linkages and wedges for excessive wear or damage [Figure 228]. Replace any parts that are damaged, bent or missing. Keep all fasteners tight.

Look for cracked welds. Contact your Bobcat dealer for repair or replacement parts.

Lubricate the wedges. (See SERVICE SCHEDULE on Page 105.) and (See LUBRICATING THE LOADER on Page 142.)

BOB-TACH (POWER)

This machine may be equipped with a Power Bob-Tach.

Inspection And Maintenance

Figure 229

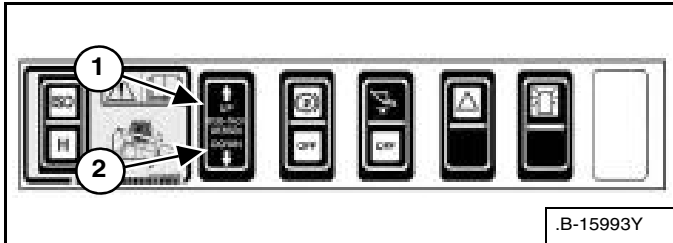

Push and hold the BOB-TACH “WEDGES UP” switch (Item 1) until wedges are fully raised. Push and hold the BOB-TACH “WEDGES DOWN” switch (Item 2) [Figure 229] until the wedges are fully down.

The levers and wedges must move freely.

! WARNING

AVOID INJURY OR DEATH

The Bob-Tach wedges must extend through the holes in the attachment mounting frame. Levers must be fully down and locked. Failure to secure wedges can allow attachment to come off.

W-2715-0208

Figure 230

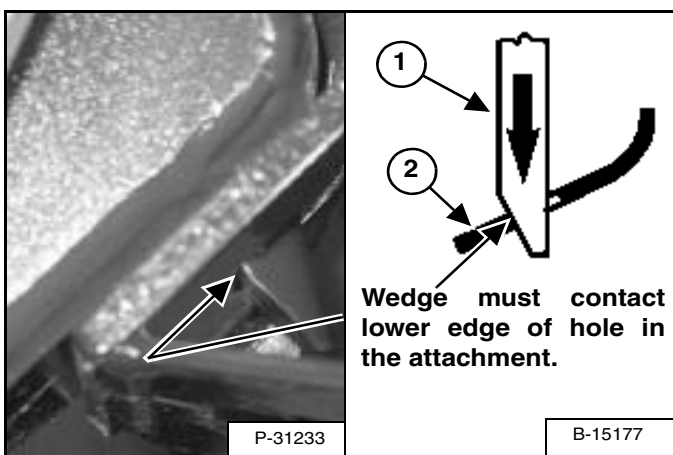

The wedges (Item 1) [Figure 230] must extend through the holes in the attachment mounting frame.

The spring loaded wedge (Item 1) must contact the lower edge of the hole in the attachment (Item 2) [Figure 230].

If the wedge does not contact the lower edge of the hole [Figure 230], the attachment will be loose and can come off the Bob-Tach.

Figure 231

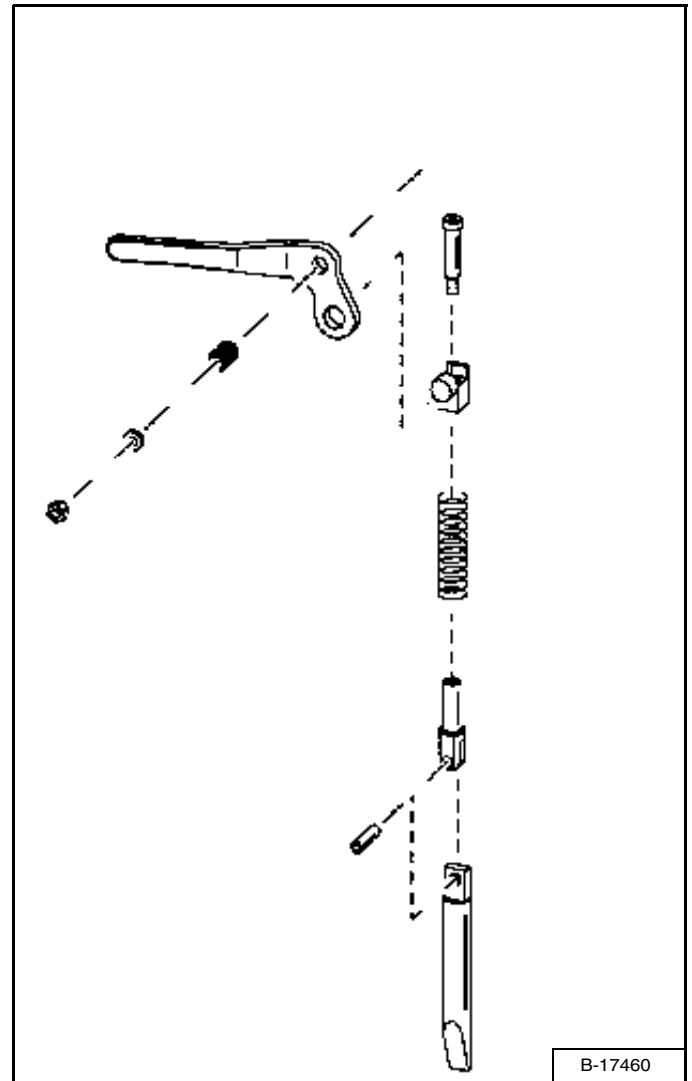

Inspect the mounting frame on the attachment and Bob-Tach, linkages and wedges for excessive wear or damage [Figure 231]. Replace any parts that are damaged, bent or missing. Keep all fasteners tight.

Look for cracked welds. Contact your Bobcat dealer for repair or replacement parts.

Lubricate the wedges. (See SERVICE SCHEDULE on Page 105.) (See LUBRICATING THE LOADER on Page 142.)



LOADER STORAGE AND RETURN TO SERVICE

Storage

Sometimes it may be necessary to store your Bobcat loader for an extend period of time. Below is a list of items to perform before storage.

- Thoroughly clean the loader including the engine compartment.
- Lubricate the loader.
- Replace worn or damaged parts.
- Park the loader in a dry protected shelter.
- Lower the lift arms all the way and put the bucket flat on the ground.
- Put blocks under the frame to remove weight from the tracks.
- Put grease on any exposed cylinder rods.
- Put fuel stabiliser in the fuel tank and run the engine a few minutes to circulate the stabiliser to the pump and fuel injectors.

If biodiesel blend fuel has been used, perform the following:

Drain the fuel tank, refill with 100% petroleum diesel fuel, add fuel stabiliser and run the engine for at least 30 minutes.

- Drain and flush the cooling system. Refill with premixed coolant.
- Replace all fluids and filters (engine, hydraulic / hydrostatic).
- Replace air cleaner and heater filters.
- Put all controls in neutral position.
- Remove the battery. Be sure the electrolyte level is correct then charge the battery. Store it in a cool dry place above freezing temperatures and charge it periodically during storage.
- Cover the exhaust pipe opening.
- Tag the machine to indicate that it is in storage condition.

Return To Service

After the Bobcat loader has been in storage, it is necessary to follow a list of items to return the loader to service.

- Check the engine and hydraulic oil levels; check coolant level.
- Install a fully charged battery.
- Remove grease from exposed cylinder rods.
- Check all belt tensions.
- Be sure all shields and guards are in place.
- Lubricate the loader.
- Check track condition and remove blocks from under frame.
- Remove cover from exhaust pipe opening.
- Start the engine and let run for a few minutes while observing the instrument panels and systems for correct operation.
- Operate machine, check for correct function.
- Stop the engine and check for leaks. Repair as needed.



Bobcat®



SYSTEM SETUP & ANALYSIS

DIAGNOSTIC SERVICE CODES	151
Viewing Service Codes	151
Service Codes List	152
CONTROL PANEL SETUP	157
Right Panel Setup (Deluxe Instrumentation Panel)	157
Attachment Control Information (Deluxe Instrumentation Panel)	158
PASSWORD SETUP (KEYLESS START PANEL)	159
Password Description	159
Changing The Owner Password	159
Password Lockout Feature	159
PASSWORD SETUP (DELUXE INSTRUMENTATION PANEL)	160
Password Description	160
Changing The Owner Password	160
Changing The User Passwords	161
Password Lockout Feature	161
MAINTENANCE CLOCK	162
Description	162
Setup	162
Reset	162



Bobcat®



DIAGNOSTIC SERVICE CODES

Viewing Service Codes

The Service Codes will aid your dealer in diagnosing conditions which can damage your machine.

Figure 232

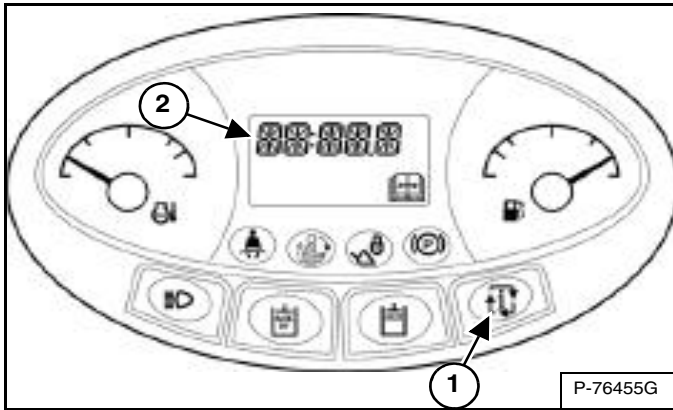

Press the INFORMATION button (Item 1) to cycle the DATA DISPLAY (Item 2) [Figure 232] until the service code screen is displayed. If more than one SERVICE CODE is present, the codes will scroll on the DATA DISPLAY.

NOTE: Corroded or loose earths can cause multiple service codes and / or abnormal symptoms. All instrument panel lights flashing, alarm sounding, headlights and taillights flashing, could indicate a bad earth. The same symptoms could apply if the voltage is low, such as loose or corroded battery cables. If you observe these symptoms, check earths and positive leads first.

Deluxe Instrumentation Panel

The optional Deluxe Instrumentation Panel offers an additional view of service codes.

Figure 233

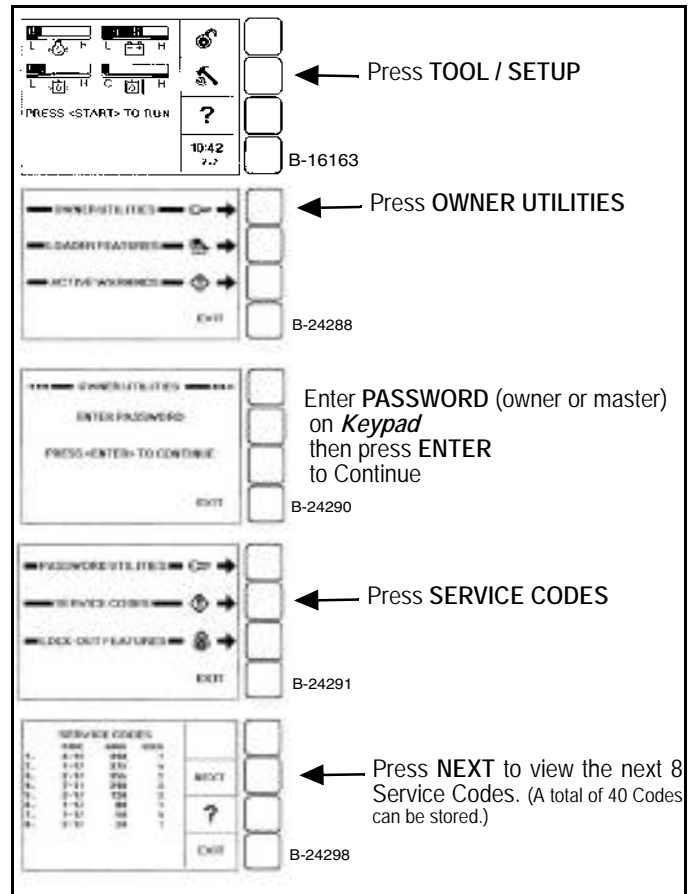

The Display Panel will list the Code Number, (CODE) hourmeter reading when the error occurred (HOUR), and the User (USER) who was logged in to operate the machine when the error occurred [Figure 233].

A total of 40 Codes can be stored. When more than 40 codes occur, the oldest code will disappear and the newest code will be in the number 1 position.



DIAGNOSTIC SERVICE CODES (CONT'D)

Service Codes List

Figure 234

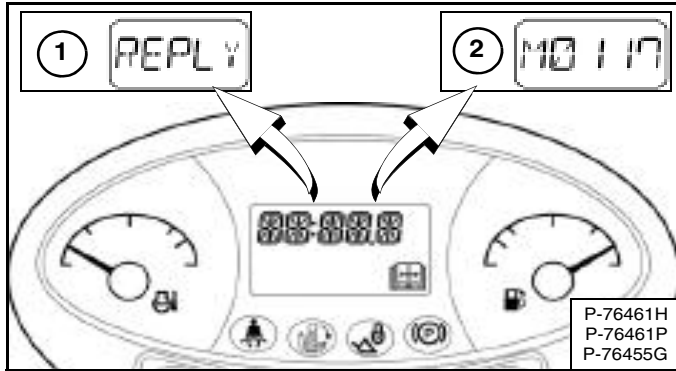

Service Codes may be either a word (Item 1) or a number (Item 2) [Figure 234].

The following word errors may be displayed:

[REPLY] One or both instrument panel(s) not communicating with the controller.

[CODE] The controller is asking for a password. (Keyless Start and Deluxe Instrumentation Panels only.)

[ERROR] The wrong password was entered. (Keyless Start and Deluxe Instrumentation Panels only.)

[SHTDN] A shutdown condition exists.

[DOOR] Operator cab door is open. (Lift and Tilt functions will not operate.)

CODE	DESCRIPTION	CODE	DESCRIPTION
A0618	Wheel speed out of range	A8406	ACD output 'E' short to ground
A3623	ACD not programmed	A8407	ACD output 'E' open circuit
A4621	Sensor supply 2 out of range high	A8432	ACD output 'E' overcurrent
A4622	Sensor supply 2 out of range low	A8502	ACD output 'F' error ON
A4721	Sensor supply 1 out of range high	A8503	ACD output 'F' error OFF
A4722	Sensor supply 1 out of range low	A8505	ACD output 'F' short to battery
A8002	ACD output 'A' error ON	A8506	ACD output 'F' short to ground
A8003	ACD output 'A' error OFF	A8507	ACD output 'F' open circuit
A8005	ACD output 'A' short to battery	A8532	ACD output 'F' overcurrent
A8006	ACD output 'A' short to ground	A8602	ACD output 'G' error ON
A8007	ACD output 'A' open circuit	A8603	ACD output 'G' error OFF
A8032	ACD output 'A' overcurrent	A8605	ACD output 'G' short to battery
A8102	ACD output 'B' error ON	A8606	ACD output 'G' short to ground
A8103	ACD output 'B' error OFF	A8607	ACD output 'G' open circuit
A8105	ACD output 'B' short to battery	A8702	ACD output 'H' error ON
A8106	ACD output 'B' short to ground	A8703	ACD output 'H' error OFF
A8107	ACD output 'B' open circuit	A8705	ACD output 'H' short to battery
A8132	ACD output 'B' overcurrent	A8706	ACD output 'H' short to ground
A8202	ACD output 'C' error ON	A8707	ACD output 'H' open circuit
A8203	ACD output 'C' error OFF	A8802	Reverse solenoid error ON
A8205	ACD output 'C' short to battery	A8803	Reverse solenoid error OFF
A8206	ACD output 'C' short to ground		
A8207	ACD output 'C' open circuit	D3905	Left joystick X-axis not in neutral
A8232	ACD output 'C' overcurrent	D3907	Left joystick Y-axis not in neutral
A8302	ACD output 'D' error ON	D4007	Right joystick Y-axis not in neutral
A8303	ACD output 'D' error OFF	D7501	CAN joystick communication error
A8305	ACD output 'D' short to battery	D7504	No communication from drive controller
A8306	ACD output 'D' short to ground	D7505	Left joystick X-axis not in neutral
A8307	ACD output 'D' open circuit	D7507	Left joystick Y-axis not in neutral
A8332	ACD output 'D' overcurrent	D7508	Right joystick Y-axis not in neutral
A8402	ACD output 'E' error ON	D7509	Operating mode switch short to ground or battery
A8403	ACD output 'E' error OFF	D7510	Improper joysticks installed
A8405	ACD output 'E' short to battery	D7511	Left speed sensor not connected



DIAGNOSTIC SERVICE CODES (CONT'D)

Service Codes List (Cont'd)

CODE	DESCRIPTION	CODE	DESCRIPTION
D7512	Right speed sensor not connected	D7564	Left rear steer retract short to ground
D7513	Right front wheel angle sensor stuck	D7565	Steer pressure short to ground
D7514	Left front wheel angle sensor stuck	D7566	Back-up alarm error OFF
D7515	Right rear wheel angle sensor stuck	D7567	No communication from Gateway controller
D7516	Left rear wheel angle sensor stuck	D7568	Angle sensors not calibrated
D7517	Left swash plate not in neutral	D7569	Battery voltage out of range high
D7518	Right swash plate not in neutral	D7570	Interrupted power (also occurs after software update)
D7519	Left joystick X-axis out of range high	D7571	Battery voltage out of range low
D7521	Left joystick Y-axis out of range high	D7572	Drive pump not calibrated
D7522	Right joystick Y-axis out of range high	D7573	Operating mode switch flipped while operating
D7523	Right front wheel angle sensor out of range high	D7574	Right wheel speed uncommanded motion
D7524	Left front wheel angle sensor out of range high	D7575	Left wheel speed uncommanded motion
D7525	Right rear wheel angle sensor out of range high	D7576	No communication from ACS controller
D7526	Left rear wheel angle sensor out of range high	D7577	Left speed sensor out of range high
D7527	Left swash plate out of position	D7578	Right speed sensor out of range high
D7528	Right swash plate out of position	D7579	Left speed sensor out of range low
D7529	Left joystick X-axis out of range low	D7580	Right speed sensor out of range low
D7531	Left joystick Y-axis out of range low	D7581	Right front steer retract short to battery
D7532	Right joystick Y-axis out of range low	D7582	Left front steer retract short to battery
D7533	Right front wheel angle sensor out of range low	D7583	Right rear steer retract short to battery
D7534	Left front wheel angle sensor out of range low	D7584	Left rear steer retract short to battery
D7535	Right rear wheel angle sensor out of range low	D7585	Sensor supply 1 out of range high
D7536	Left rear wheel angle sensor out of range low	D7586	Sensor supply 2 out of range high
D7537	Sensor supply 1 out of range low	D7587	Software update required
D7538	Sensor supply 2 out of range low	D7588	Switched power stuck ON
D7539	Left swash plate sensor out of range high	D7589	Switched power error OFF
D7540	Left swash plate sensor out of range low	D7590	Drive calibration performed
D7541	Right swash plate sensor out of range high	D7591	Left swash plate sensor reversed
D7542	Right swash plate sensor out of range low	D7592	Right swash plate sensor reversed
D7543	Left forward drive solenoid error ON	D7593	Right speed sensor unresponsive
D7544	Left reverse drive solenoid error ON	D7594	Left speed sensor unresponsive
D7545	Right forward drive solenoid error ON	D7595	Left speed sensor reversed
D7546	Right reverse drive solenoid error ON	D7596	Right speed sensor reversed
D7547	Right front steer extend short to battery	D7597	Controller programmed
D7548	Left front steer extend short to battery	D7598	In drive calibration mode
D7549	Right rear steer extend short to battery	D7599	In angle calibration mode
D7550	Left rear steer extend short to battery		
D7551	Steer pressure short to battery	H1121	Boost Sensor out of range high
D7552	Back-up alarm error ON	H1122	Boost Sensor out of range low
D7553	Left forward drive solenoid error OFF	H1221	Right Primary out of range high
D7554	Left reverse drive solenoid error OFF	H1222	Right Primary out of range low
D7555	Right forward drive solenoid error OFF	H1224	Right Primary not in neutral
D7556	Right reverse drive solenoid error OFF	H1321	Left Primary out of range high
D7557	Right front steer extend short to ground	H1322	Left Primary out of range low
D7558	Right front steer retract short to ground	H1324	Left Primary not in neutral
D7559	Left front steer extend short to ground	H2005	Boost solenoid short to battery
D7560	Left front steer retract short to ground	H2006	Boost solenoid short to ground
D7561	Right rear steer extend short to ground	H2007	Boost solenoid open circuit
D7562	Right rear steer retract short to ground	H2032	Boost solenoid overcurrent
D7563	Left rear steer extend short to ground	H2205	Pressure control solenoid short to battery



DIAGNOSTIC SERVICE CODES (CONT'D)

Service Codes List (Cont'd)

CODE	DESCRIPTION	CODE	DESCRIPTION
H2206	Pressure control solenoid short to ground	H7328	Remote control no signal
H2207	Pressure control solenoid open circuit	H7404	Main controller no communication
H2232	Pressure control solenoid overcurrent	H7604	Left hand panel no communication
H2305	Rear base solenoid short to battery		
H2306	Rear base solenoid short to ground	L0102	Left panel button 1 error ON
H2307	Rear base solenoid open circuit	L0202	Left panel button 2 error ON
H2332	Rear base solenoid overcurrent	L0302	Left panel button 3 error ON
H2405	Rear rod solenoid short to battery	L0402	Left panel button 4 error ON
H2406	Rear rod solenoid short to ground	L7404	Left panel main controller no communication
H2407	Rear rod solenoid open circuit	L7672	Left panel programming error
H2432	Rear rod solenoid overcurrent		
H2505	Rear aux relief short to battery	M0116	Air filter not connected
H2506	Rear aux relief short to ground	M0117	Air filter plugged
H2507	Rear aux relief open circuit	M0216	Hydraulic/Hydrostatic filter not connected
H2605	Front base solenoid short to battery	M0217	Hydraulic/Hydrostatic filter plugged
H2606	Front base solenoid short to ground	M0309	Battery voltage low
H2607	Front base solenoid open circuit	M0310	Battery voltage high
H2632	Front base solenoid overcurrent	M0311	Battery voltage extremely high
H2705	Front rod solenoid short to battery	M0314	Battery voltage extremely low
H2706	Front rod solenoid short to ground	M0322	Battery voltage out of range low
H2707	Front rod solenoid open circuit	M0409	Engine oil pressure low
H2732	Front rod solenoid overcurrent	M0414	Engine oil pressure extremely low
H2805	Diverter rod solenoid short to battery	M0415	Engine oil pressure shutdown
H2806	Diverter rod solenoid short to ground	M0421	Engine oil pressure out of range high
H2807	Diverter rod solenoid open circuit	M0422	Engine oil pressure out of range low
H2905	High-flow solenoid short to battery	M0509	Hydraulic charge pressure low
H2906	High-flow solenoid short to ground	M0510	Hydraulic charge pressure high
H2907	High-flow solenoid open circuit	M0511	Hydraulic charge pressure extremely high
H2932	High-flow solenoid overcurrent	M0514	Hydraulic charge pressure extremely low
H3028	Controller memory failure	M0515	Hydraulic charge pressure shutdown
H3128	Interrupted power failure	M0521	Hydraulic charge pressure out of range high
H3648	ACD multiple	M0522	Hydraulic charge pressure out of range low
H3913	Left joystick grip no communication	M0610	Engine speed high
H3916	Left joystick not connected	M0611	Engine speed extremely high
H3928	Left joystick failure	M0613	Engine speed no signal
H3948	Left joystick multiple	M0615	Engine speed shutdown
H4013	Right joystick grip no communication	M0618	Engine speed out of range
H4016	Right joystick not connected	M0634	Engine speed invalid data from ECU
H4028	Right joystick failure	M0710	Hydraulic oil temperature high
H4048	Right joystick multiple	M0711	Hydraulic oil temperature extremely high
H4302	Horn error ON	M0715	Hydraulic oil temperature shutdown
H4303	Horn error OFF	M0721	Hydraulic oil temperature out of range high
H4423	Auxiliary not programmed	M0722	Hydraulic oil temperature out of range low
H4502	Right signal error ON	M0810	Engine coolant temperature high
H4503	Right signal error OFF	M0811	Engine coolant temperature extremely high
H4602	Left signal error ON	M0815	Engine coolant temperature shutdown
H4603	Left signal error OFF	M0821	Engine coolant temperature out of range high
H4721	Sensor supply 1 out of range high	M0822	Engine coolant temperature out of range low
H4722	Sensor supply 1 out of range low	M0909	Fuel level low
H7314	Remote control failure	M0921	Fuel level out of range high



DIAGNOSTIC SERVICE CODES (CONT'D)

Service Codes List (Cont'd)

CODE	DESCRIPTION	CODE	DESCRIPTION
M0922	Fuel level out of range low	M2821	Throttle secondary out of range high
M1016	Hydraulic charge filter not connected	M2822	Throttle secondary out of range low
M1017	Hydraulic charge filter plugged	M3128	Interrupted power failure
M1121	Seat bar sensor out of range high	M3204	Workgroup no communication
M1122	Seat bar sensor out of range low	M3304	Deluxe panel no communication
M1128	Seat bar sensor failure	M3404	Deluxe panel no communication
M1305	Fuel hold solenoid short to battery	M3505	Hydraulic fan short to battery
M1306	Fuel hold solenoid short to ground	M3506	Hydraulic fan short to ground
M1307	Fuel hold solenoid open circuit	M3507	Hydraulic fan open circuit
M1402	Fuel pull output error ON	M3532	Hydraulic fan overcurrent
M1403	Fuel pull output error OFF	M3705	Two-speed secondary short to battery
M1407	Fuel pull output open circuit	M3706	Two-speed secondary short to ground
M1428	Fuel pull output failure	M3707	Two-speed secondary open circuit
M1502	Traction lock pull output error ON	M3732	Two-speed secondary overcurrent
M1503	Traction lock pull output error OFF	M3805	Auxiliary hydraulic lock short to battery
M1507	Traction lock pull output open circuit	M3806	Auxiliary hydraulic lock short to ground
M1528	Traction lock pull output failure	M3807	Auxiliary hydraulic lock open circuit
M1605	Traction lock hold solenoid short to battery	M3832	Auxiliary hydraulic lock overcurrent
M1606	Traction lock hold solenoid short to ground	M4109	Alternator low
M1607	Traction lock hold solenoid open circuit	M4110	Alternator high
M1705	Hydraulic lock valve solenoid short to battery	M4304	Keyless panel no communication
M1706	Hydraulic lock valve solenoid short to ground	M4404	Auxiliary no communication
M1707	Hydraulic lock valve solenoid open circuit	M4521	Water in fuel sensor out of range high
M1732	Hydraulic lock valve solenoid overcurrent	M4522	Water in fuel sensor out of range low
M1805	Lift spool lock short to battery	M4530	Water in fuel sensor fault
M1806	Lift spool lock short to ground	M4621	5 volt sensor supply out of range high
M1807	Lift spool lock open circuit	M4622	5 volt sensor supply out of range low
M1832	Lift spool lock overcurrent	M4721	8 volt sensor supply out of range high
M2005	Two-speed primary short to battery	M4722	8 volt sensor supply out of range low
M2006	Two-speed primary short to ground	M4802	Front light relay error ON
M2007	Two-speed primary open circuit	M4803	Front light relay error OFF
M2032	Two-speed primary overcurrent	M4807	Front light relay open circuit
M2102	Glow plug output error ON	M4902	Rear light relay error ON
M2103	Glow plug output error OFF	M4903	Rear light relay error OFF
M2107	Glow plug output open circuit	M4907	Rear light relay open circuit
M2128	Glow plug output failure	M5002	Front light output error ON
M2202	Starter output error ON	M5003	Front light output error OFF
M2203	Starter output error OFF	M5007	Front light output open circuit
M2207	Starter output open circuit	M5028	Front light output failure
M2228	Starter output failure	M5102	Rear light output error ON
M2302	Starter relay error ON	M5103	Rear light output error OFF
M2303	Starter relay error OFF	M5107	Rear light output open circuit
M2402	Fuel pull relay error ON	M5128	Rear light output failure
M2403	Fuel pull relay error OFF	M5202	PTOL switch error ON
M2502	Traction pull relay error ON	M5221	PTOL switch out of range high
M2503	Traction pull relay error OFF	M5222	PTOL switch out of range low
M2602	Glow plug relay error ON	M5305	PTOL LED short to battery
M2603	Glow plug relay error OFF	M5306	PTOL LED short to ground
M2721	Throttle primary out of range high	M5405	Tilt spool lock short to battery
M2722	Throttle primary out of range low	M5406	Tilt spool lock short to ground



DIAGNOSTIC SERVICE CODES (CONT'D)

Service Codes List (Cont'd)

CODE	DESCRIPTION	CODE	DESCRIPTION
M5407	Tilt spool lock open circuit	M8615	Engine speed derate shutdown
M5432	Tilt spool lock overcurrent	M8625	Engine speed derate unresponsive
M5902	DPF force regeneration switch error ON	M8715	Torque derate shutdown
M5948	DPF switch multiple	M8725	Torque derate unresponsive
M6002	DPF inhibit regeneration switch error ON		
M6402	Switched power relay error ON	W3223	ACS calibration required
M6403	Switched power relay error OFF	W3224	ACS calibration performed
M6505	EEC power short to battery	W3225	ACS calibration failed
M6506	EEC power short to ground	W3231	Tilt actuator fault
M6507	EEC power open circuit	W3232	Tilt actuator wiring fault
M6604	EEC power no communications	W3233	Tilt handle wiring fault
M6702	HVAC output error ON	W3234	Tilt actuator not in neutral
M6703	HVAC output error OFF	W3235	Tilt handle / pedal not in neutral
M6707	HVAC output open circuit	W3236	Lift actuator fault
M6728	HVAC output failure	W3237	Lift actuator wiring fault
M6802	HVAC relay error ON	W3238	Lift handle wiring fault
M6803	HVAC relay error OFF	W3239	Lift actuator not in neutral
M7002	Switched power output error ON	W3240	Lift handle / pedal not in neutral
M7003	Switched power output error OFF	W3241	No communication
M7007	Switched power output open circuit	W3249	Lift actuator short to ground
M7028	Switched power output failure	W3250	Tilt actuator short to ground
M7102	Electric fan 1 output error ON	W3251	Lift actuator short to battery
M7103	Electric fan 1 output error OFF	W3252	Tilt actuator short to battery
M7128	Electric fan 1 output failure	W3253	Lift handle / pedal short to ground
M7202	Electric fan 1 relay error ON	W3254	Tilt handle / pedal short to ground
M7203	Electric fan 1 relay error OFF	W3255	Lift handle / pedal short to battery
M7207	Electric fan 1 relay open circuit	W3256	Tilt handle / pedal short to battery
M7304	Remote control no communication	W3257	Lift actuator reduced performance
M7316	Remote control not connected	W3258	Tilt actuator reduced performance
M7423	Main controller not programmed	W3259	Lift actuator wrong direction
M7472	Main controller in boot code	W3260	Tilt actuator wrong direction
M7497	Main controller software updated	W3261	Handle lock short to ground
M7504	Drive no communication	W3262	Handle lock short to battery
M7604	Left display panel no communication	W3263	Pedal lock short to ground
M7748	Key switch multiple	W3264	Pedal lock short to battery
M7839	Hourmeter changed	W3265	Sensor supply voltage out of range
M7974	Door open	W3266	Battery voltage out of range
M8541	DPF automatic regeneration active	W3267	Handle/pedal switch flipped while operating
M8542	DPF automatic regeneration active	W3268	Lift handle information error
M8543	DPF regeneration required	W3270	Right hand drive short to ground
M8550	DPF service regeneration required	W3271	Right hand drive short to battery
M8551	DPF regeneration required but inhibited	W3274	Left joystick X-axis out of range
M8552	DPF regeneration required but inhibited	W3275	Interrupted unswitched power
M8553	DPF service regeneration required	W3276	CAN joystick information error
M8554	DPF service regeneration required	W3277	Remote control information error
M8560	DPF service regeneration active	W3297	Controller programmed
M8561	DPF service regeneration active	W3905	Left joystick X-axis not in neutral
M8562	DPF service regeneration active	W4005	Right joystick X-axis not in neutral
M8563	DPF service regeneration active	W4007	Right joystick Y-axis not in neutral
M8564	DPF service regeneration active		



CONTROL PANEL SETUP

Right Panel Setup (Deluxe Instrumentation Panel)

Icon Identification

Figure 235

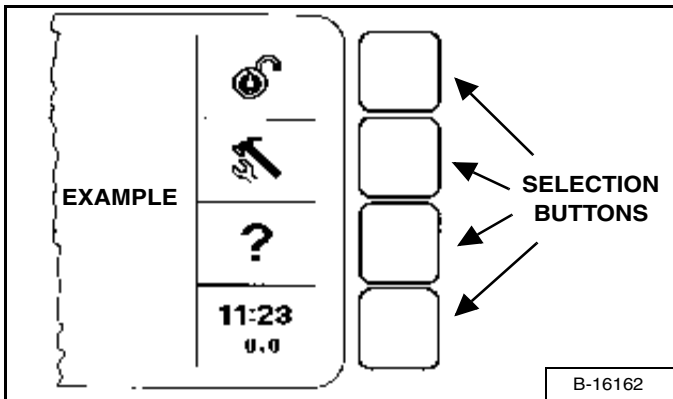

Make selection by pressing the SELECTION BUTTON adjacent to the icon [Figure 235].

ICON	DESCRIPTION
	LOCK / UNLOCK: Allows machine to be locked / unlocked. You must lock machine to activate security system. When system is unlocked, the user can press RUN / ENTER then press START to begin operation.
	A valid password will need to be entered at startup to run a locked machine.
	TOOL / SETUP: Access system options. Use to set clock, check system warnings, select language, set passwords, etc.
?	HELP: Access help on current menu item.
EXIT	EXIT returns you to previous level menu.
11:23 0.0	CLOCK / JOB CLOCK: Press to clear or lock job clock; TOOL / SETUP to set time.
↑	UP ARROW: Goes backward one screen.
↓	DOWN ARROW: Goes forward one screen.
↑ ↓	OUTLINE ARROWS: No screen available (backward / forward).
→	SELECTION ARROW: Use to select menu item.
NEXT	Goes to the NEXT screen in series. EXAMPLE: the next Active Warning screen.
INFO	Goes to more information about attachments.
YES / NO	Answer yes / no to current setup question.
CLEAR	Removes previously installed password.
SET	Set accepts current installed password.

Examples

Figure 236

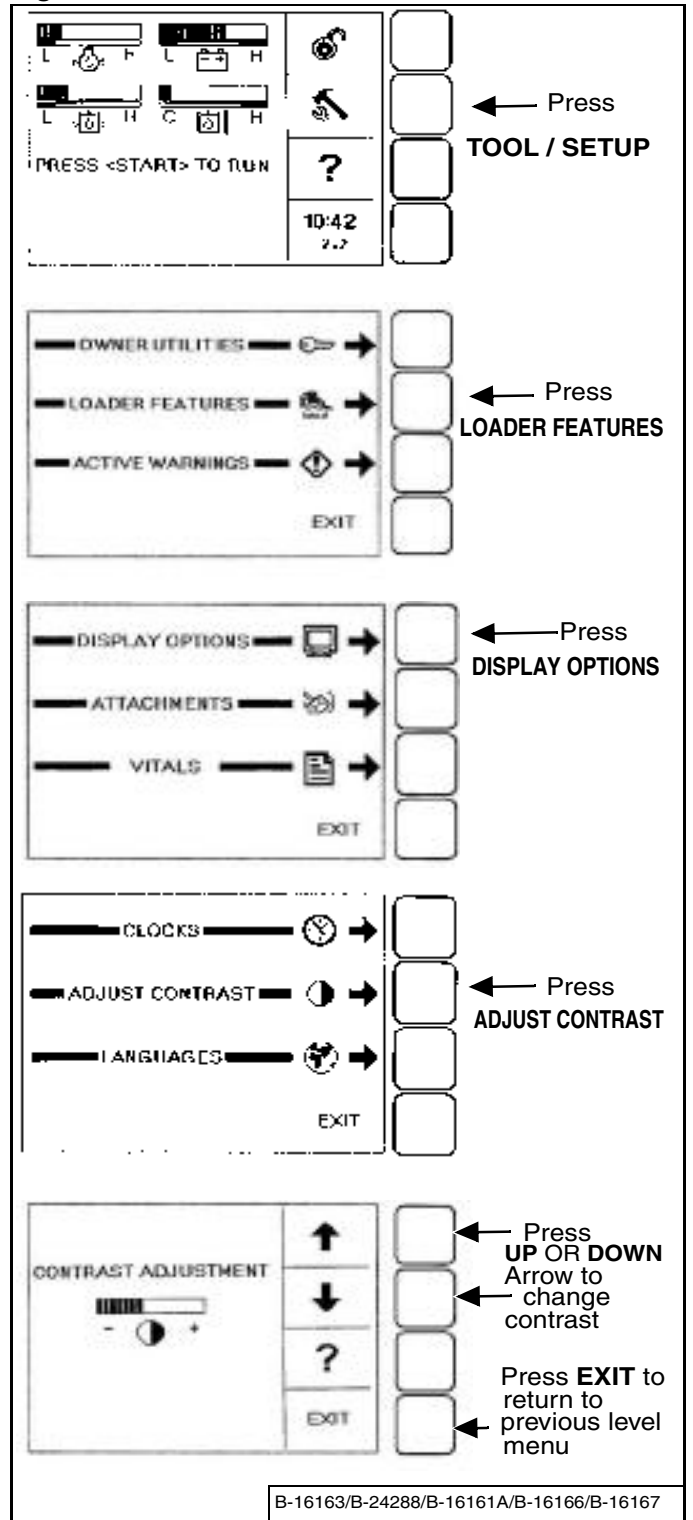

B-16163/B-24288/B-16161A/B-16166/B-16167



CONTROL PANEL SETUP (CONT'D)

**Right Panel Setup (Deluxe Instrumentation Panel)
(Cont'd)**

More Examples

Clocks

Press . . .

- TOOL / SETUP**
- LOADER FEATURES**
- DISPLAY OPTIONS**
- CLOCKS**

SET CLOCK

Use the keypad to set time.
Press **RUN / ENTER** to set clock.
Press **EXIT** to return to previous level menu.

RESET JOB CLOCK (Password required)

(Job Clock keeps a running total for job hours)
Press **CLEAR** to reset Job Clock to zero.
Press **LOCK / UNLOCK** to unlock.
Enter Password and press **RUN / ENTER**.

Languages

Press . . .

- TOOL / SETUP**
- LOADER FEATURES**
- DISPLAY OPTIONS**

LANGUAGES

Select the language, press **RUN / ENTER**.
Press **EXIT** to return to previous level menu.

Vitals (Monitor the engine, hydraulic / hydrostatic, electrical functions when engine is running.)

Press . . .

- TOOL / SETUP**
- LOADER FEATURES.**

VITALS

Press **SELECTION ARROW** to select METRIC or ENGLISH (M / E) readouts

You can monitor real-time readouts of:

- Engine Oil Pressure**
- Engine Coolant Temperature**
- Hydraulic Charge Pressure**
- Hydraulic Oil Temperature**
- System Voltage**
- Engine Speed**

The Deluxe Instrumentation Panel is easy to use. Continue to set your own preferences for running / monitoring your Bobcat loader.

Attachment Control Information (Deluxe Instrumentation Panel)

The Deluxe Instrumentation Panel allows the user to view information concerning the operation of Bobcat attachments.

Figure 237

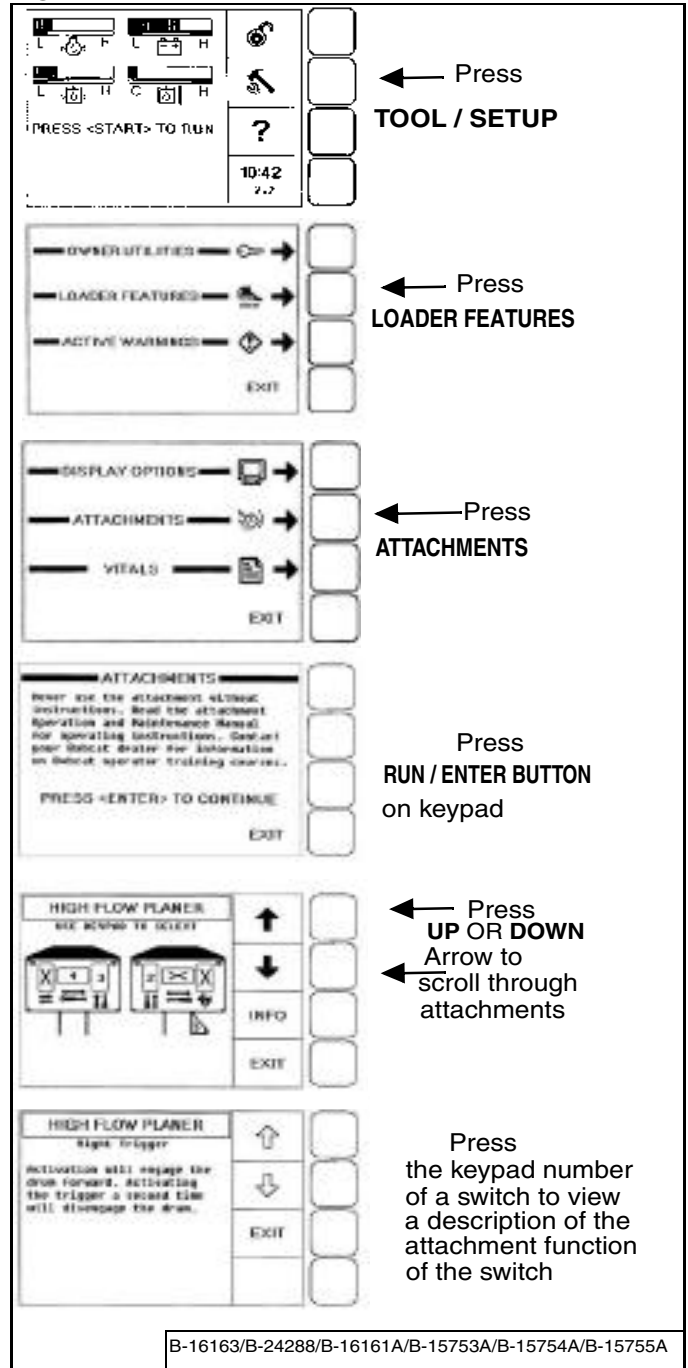

Attachments are listed alphabetically [Figure 237]. Press the exit button to return one screen or press the "0" (zero) key to return to the home screen immediately.

PASSWORD SETUP (KEYLESS START PANEL)

Password Description

Master Password:

A permanent, randomly selected password set at the factory which cannot be changed. This password is used for service by the Bobcat dealer if the owner password is not known; or to change the owner password.

Owner Password:

Allows for full use of the loader. It must be used to change the owner password.

Changing The Owner Password

Press the RUN button to turn on the loader's electrical system.

Enter the five digit owner password using the number keys (1 through 0) if locked.

Figure 238

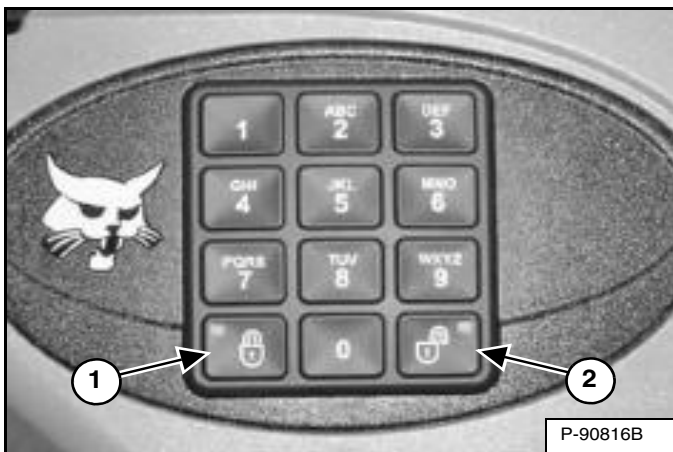

Press and hold the lock (Item 1) and unlock (Item 2) [Figure 238] keys for two seconds.

The lock key red light will flash and the left panel display screen will show [ENTER].

Enter a new five digit password using the number keys (1 through 0). An asterisk will show in the left panel display screen for each key press.

The left panel display screen will show [AGAIN].

Enter the new five digit password again.

The lock key red light will become solid.

Password Lockout Feature

This feature allows the owner to unlock the password feature so that a password does not need to be used every time the engine is started.

Press the RUN button to turn on the loader's electrical system.

Enter the five digit owner password using the number keys (1 through 0).

Figure 239

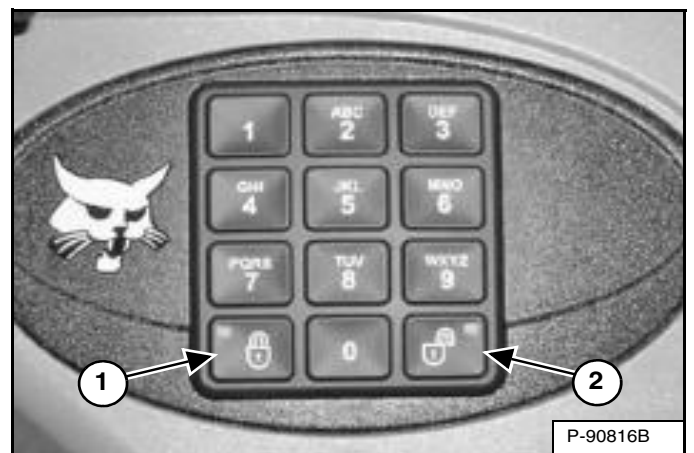

Press the unlock key (Item 2) [Figure 239].

The left panel display screen will show [CODE].

Enter the five digit owner password using the number keys (1 through 0). The unlock key green light will flash, then become solid.

The loader can now be started without using a password.

NOTE: Use the following procedure to reset the machine lock so that the loader requires a password to start the engine.

Press the RUN button to turn on the loader's electrical system.

Press the lock key (Item 1) [Figure 239].

The lock key red light will flash and the left panel display screen will show [CODE].

Enter the five digit owner password using the number keys (1 through 0). The unlock key green light will flash, then the lock key red light will become solid.

You must now enter the password every time to start the loader.



PASSWORD SETUP (DELUXE INSTRUMENTATION PANEL)

Password Setup is available on machines with a Deluxe Instrumentation Panel.

Password Description

All new machines with a Deluxe Instrumentation Panel arrive at Bobcat dealerships with the keypad in locked mode. This means that a password must be used to start the engine.

For security purposes, your dealer may change the password and also set it in the locked mode. Your dealer will provide you with the password.

Master Password:

A permanent, randomly selected password set at the factory which cannot be changed. This password is used for service by the Bobcat dealer if the owner password is not known; or to change the owner password.

Owner Password:

Allows for full use of the loader and to setup the Deluxe Instrumentation Panel. There is only one owner password. It must be used to change the owner or user passwords. Owner should change the password as soon as possible for security of the loader.

User Password:

Allows starting and operating the loader; cannot change password or any of the other setup features.

For the procedures to change passwords (See Changing The Owner Password on Page 160.) (See Changing The User Passwords on Page 161.)

Changing The Owner Password

Figure 240

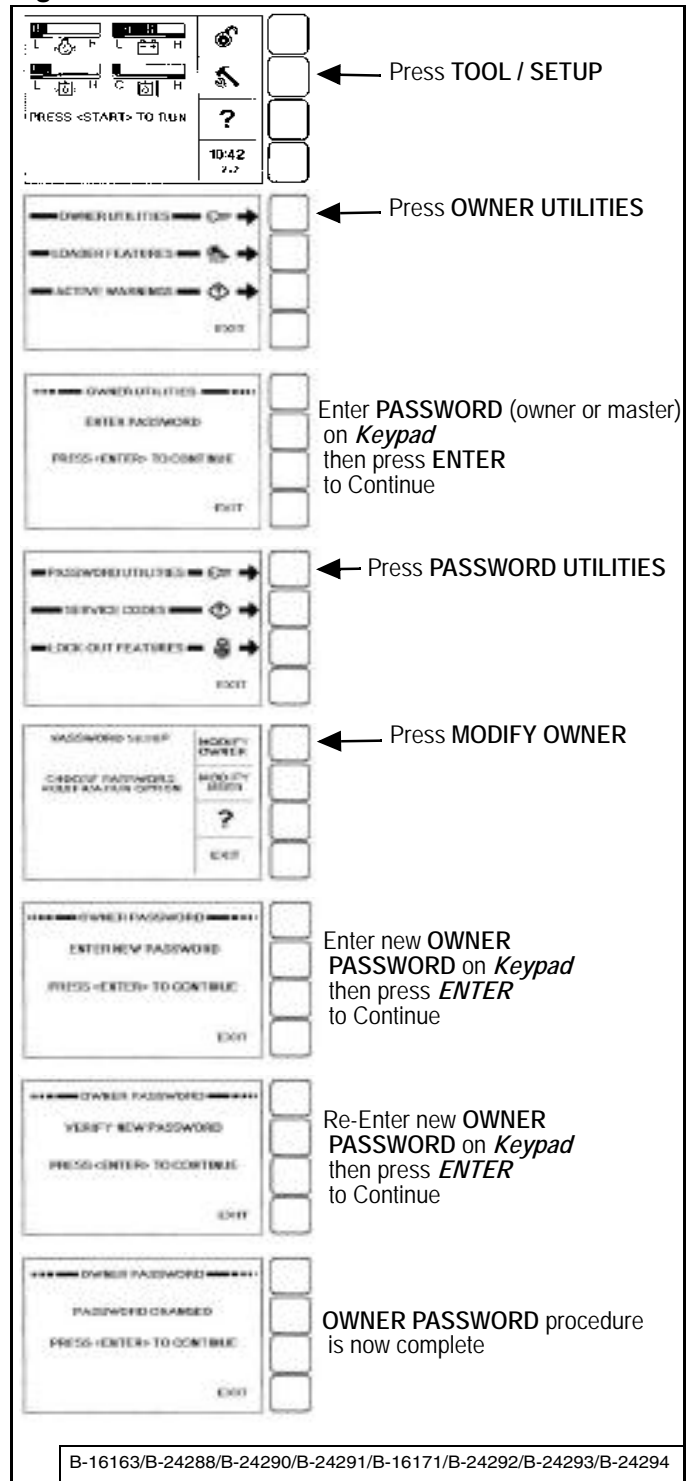



PASSWORD SETUP (DELUXE INSTRUMENTATION PANEL) (CONT'D)

Changing The User Passwords

Figure 241

Press **TOOL / SETUP**

Press **OWNER UTILITIES**

Enter **PASSWORD** (owner or master) on *Keypad* then press **ENTER** to Continue

Press **PASSWORD UTILITIES**

Press **MODIFY USER**

Enter **USER** number on *Keypad* (There can be up to 8 different Users, each with their own password) then press **ENTER** to Continue

Enter **USER PASSWORD** on *Keypad* then press **ENTER** to Continue

USER PASSWORD procedure is now complete. Enter another **USER** number
OR
Press **EXIT**

B-16163/B-24288/B-24290/B-24291/B-16171/B-24295/B-24296/B-24297A

Password Lockout Feature

This feature allows the owner to unlock the password feature so that a password does not need to be used every time the engine is started.

Figure 242

Press **LOCK / UNLOCK**

Enter **OWNER PASSWORD** on *Keypad* then press **ENTER** to Continue

Press **UNLOCK MACHINE**

Press **EXIT**

Machine is now **UNLOCKED** and can be started without using a password

B-16163/P-76075/P-76076/P-76076A/P-76077

MAINTENANCE CLOCK

Description

The Maintenance Clock alerts the operator when the next service interval is due. *EXAMPLE:* The Maintenance Clock can be set to a 250 hour interval as a reminder for the next 250 hour planned maintenance.

Figure 243

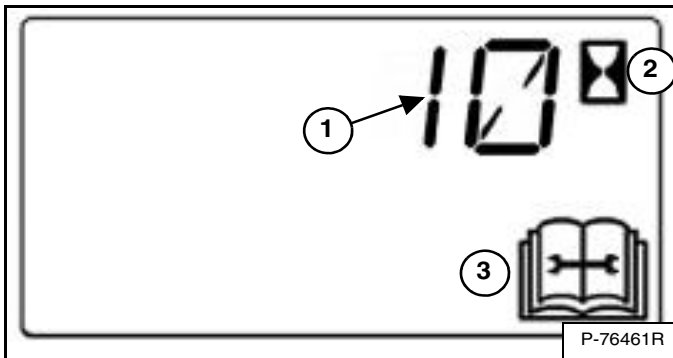

During machine operation, a two beep alarm will sound when there are less than 10 hours until the next planned maintenance.

The remaining hours before maintenance is required will appear in the data display (Item 1) for five seconds while the service icon (Item 3) and hourmeter icon (Item 2) [Figure 243] flash.

NOTE: The display will show negative numbers after counting down to zero.

The display will then revert back to the previous display and will appear for five seconds every time the machine is started until the maintenance clock is reset.

Figure 244



The Deluxe Instrumentation Panel, if equipped, will display a message (Item 1) [Figure 244] alerting the operator to service the machine.

This message will remain for 10 seconds before reverting back to the previous screen and will appear for 10 seconds every time the machine is started until the maintenance clock is reset.

Figure 245

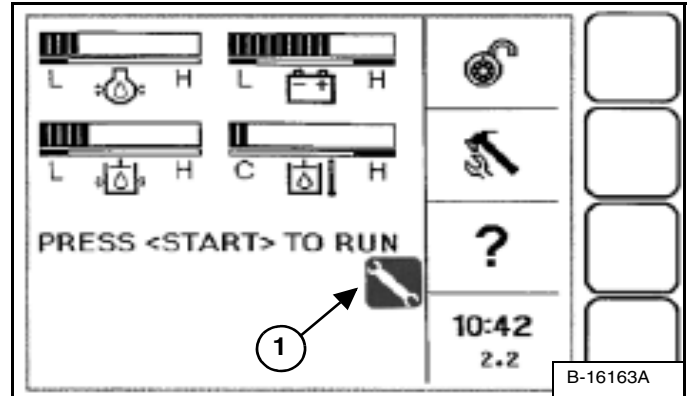

The Deluxe Instrumentation Panel, if equipped, will display a wrench icon (Item 1) [Figure 245] alerting the operator to service the machine. This icon will remain on the display until the maintenance clock is reset.

NOTE: Loaders equipped with a Standard Key Panel or Keyless Start Panel will not display the BobCARESM PM message or wrench icon on the right panel.

Setup

See your Bobcat dealer about installation of this feature.

Reset

See your Bobcat dealer to reset the maintenance clock.



SPECIFICATIONS

(T110) LOADER SPECIFICATIONS	165
Machine Dimensions	165
Performance	166
Engine	166
Controls	166
Drive System	167
Hydraulic System	167
Electrical	168
Capacities	168
Tracks	168
Ground Pressure	168
Fuel Consumption	169
Environmental	169
Temperature Range	169



Bobcat®

(T110) LOADER SPECIFICATIONS

Machine Dimensions

- Dimensions are given for loader equipped with standard track and 50 in. Construction & Industrial bucket and may vary with other bucket types. All dimensions are shown in millimeters. Respective imperial dimensions are given in inches enclosed by parentheses.
- Where applicable, specification conform to SAE or ISO standards and are subject to change without notice.

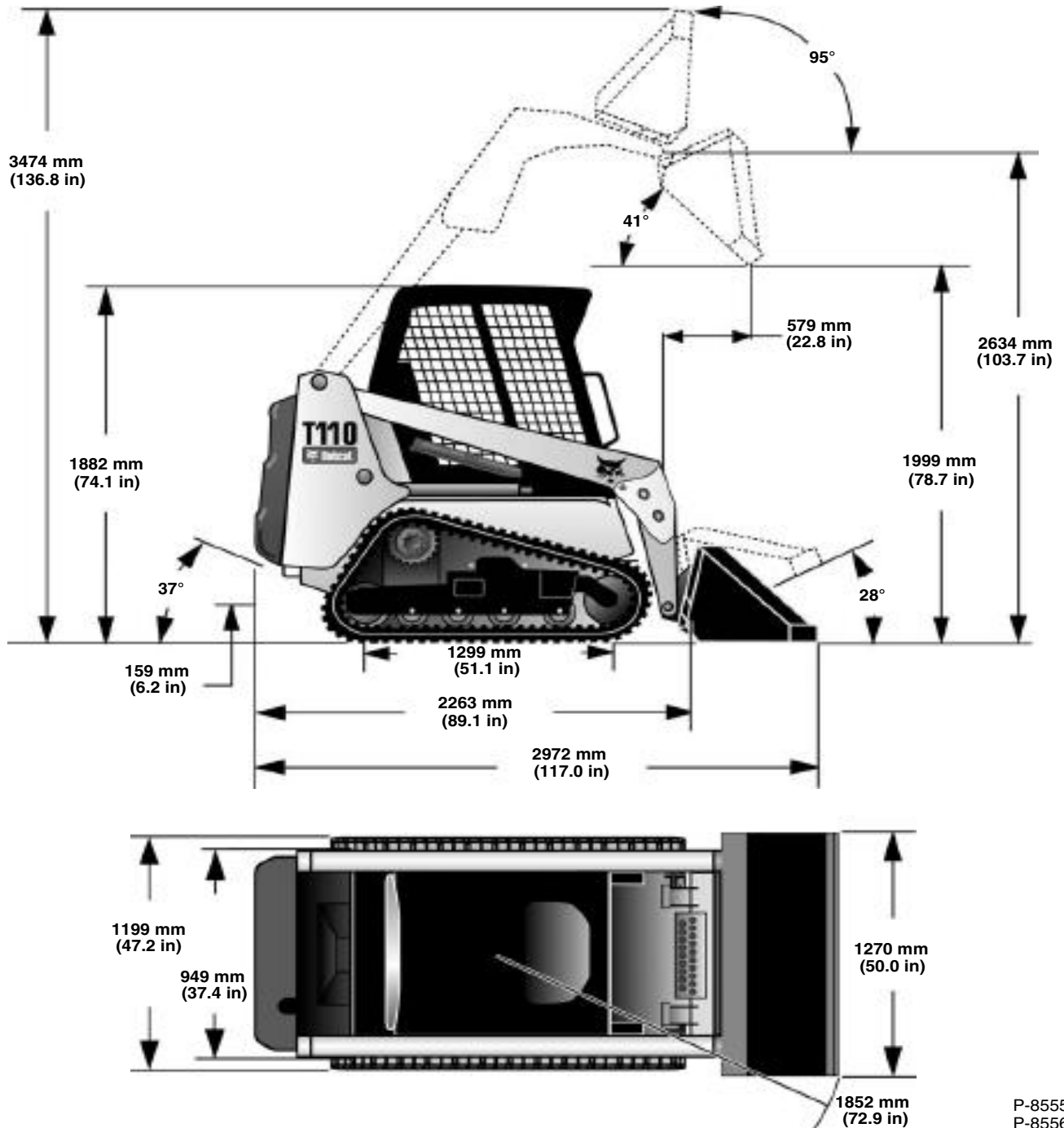

Changes of structure or weight distribution of the loader can cause changes in control and steering response and can cause failure of the loader parts.



(T110) LOADER SPECIFICATIONS (CONT'D)

Performance

	STANDARD CONTROLS	SELECTABLE JOYSTICK CONTROLS (SJC)
Rated Operating Capacity (ISO)	499 kg (1100 lb)	499 kg (1100 lb)
Tipping Load (ISO)	1443 kg (3181 lb)	1552 kg (3422 lb)
Operating Weight	2379 kg (5244 lb)	2470 kg (5445 lb)
SAE Breakout Force - Lift	1122 kg (2473 lb)	1377 kg (3035 lb)
SAE Breakout Force - Tilt	1071 kg (2360 lb)	1010 kg (2226 lb)
Push Force	1428 kg (3147 lb)	1356 kg (2990 lb)
Travel Speed - Single Speed - Two-Speed (Option)	0 - 8,4 km/h (0 - 5.2 mph) - - -	0 - 8,4 km/h (0 - 5.2 mph) 0 - 13,5 km/h (0 - 8.4 mph)

Engine

Make / Model	Kubota / V2403-M-DI-E3B Interim Tier IV
Fuel / Cooling	Diesel / Liquid
Horsepower (SAE Net)	28,9 kW (38.8 hp) @ 2200 rpm
Low Idle	1220 rpm
High Idle	2450 rpm
Torque (SAE Net)	150,4 N•m (110.9 ft-lb) @ 1400 rpm
Number of Cylinders	4
Displacement	2,434 L (148.53 in ³)
Bore / Stroke	87 mm / 102,4 mm (3.43 in / 4.03 in)
Lubrication	Gear Pump Pressure System with Filter
Crankcase Ventilation	Closed Breathing
Air Cleaner	Dry replaceable paper cartridge with separate safety element
Ignition	Diesel - Compression
Air Induction	Naturally Aspirated
Starting Aid	Glow Plugs - Automatically activated as needed in RUN position.

Controls

Vehicle Steering	Direction and speed controlled by two hand operated steering levers <i>or</i> optional joystick(s)
Loader Hydraulics - Lift and Tilt - Front Auxiliary (Standard)	Controlled by separate foot pedals <i>or</i> optional Selectable Joystick Control (SJC) Controlled by lateral movement of the right hand steering lever <i>or</i> optional Right Hand Selectable Joystick Control (SJC)
Auxiliary Pressure Release	Front quick couplers. (See Relieve Auxiliary Hydraulic Pressure in this manual.)
Engine	Hand lever speed control; key-type start switch <i>or</i> optional Deluxe Instrumentation Panel and function error shutdown.
Starting Aid	Glow Plugs automatically activated as needed by Instrument Panel
Service Brake	Two independent hydrostatic systems controlled by two hand operated steering levers <i>or</i> optional joystick(s)
Secondary Brake	One of the hydrostatic transmissions
Parking Brake (Standard)	Spring applied pressure release multi-disk brake activated by manually operated switch on front instrument panel



(T110) LOADER SPECIFICATIONS (CONT'D)

Drive System

Main Drive	Fully hydrostatic, rubber track drive
Transmission	Infinitely variable tandem hydrostatic piston pumps
Final Drive	2 fully reversing hydrostatic drive motors driving rubber tracks

Hydraulic System

Pump Type	Engine driven, gear type
Pump Capacity - Standard	47,5 L/min (12.5 U.S. gpm) @ 2200 Engine rpm @ 91% Efficiency
System Relief Valve Setting	20,7 MPa (207 bar) (3000 psi)
Filter (Hydraulic)	Full flow replaceable, 3-micron synthetic media element
Hydraulic Cylinders	Double-acting; tilt cylinders have cushioning feature on dump and rollback
Bore Diameter:	Lift Cylinder (2) 50,8 mm (2.00 in) Tilt Cylinder (2) 57,2 mm (2.25 in)
Rod Diameter:	Lift Cylinder (2) 31,8 mm (1.25 in) Tilt Cylinder (2) 31,8 mm (1.25 in)
Stroke:	Lift Cylinder (2) 653,5 mm (25.73 in) Tilt Cylinder (2) 302,0 mm (11.89 in)
Control Valve	3-Spool, open center type with spring detent for lift float and manually controlled auxiliary spool
Fluid Lines	SAE Standard tubelines, hoses and fittings
Fluid Type	Bobcat Fluid 6903117 - (2.5 U.S. gal) 6903118 - (5 U.S. gal) 6903119 - (55 U.S. gal)
Hydraulic Function Time (Standard Controls / SJC):	
Raise Lift Arms	3.0 / 2.8 Seconds
Lower Lift Arms	1.9 / 1.9 Seconds
Bucket Dump	1.6 / 1.5 Seconds
Bucket Rollback	1.3 / 1.2 Seconds



(T110) LOADER SPECIFICATIONS (CONT'D)

Electrical

Alternator	Belt driven, 90 amperes, open
Battery	12 volts, 600 cold cranking amperes @ -18°C (0°F) 115 Minute reserve capacity @ 25 amperes
Starter	12 volts, gear type, 2,7 kW (3.6 hp)
Instrumentation	<p>Gauges: Engine Coolant Temperature, Fuel Level.</p> <p>Warning lights: Fuel Level, Seat Belt, Engine Coolant Temperature, Engine Malfunction, Hydraulic Malfunction, General Warning.</p> <p>Indicators: BICS™ Functions, Two-Speed, 3-Point Shoulder Belt, Turn Signals, Engine Preheat.</p> <p>Data Display: Operating Hours, Engine rpm, Speed Management Setting, Maintenance Clock Countdown, Battery Voltage, Service Codes, Engine Preheat Countdown, Steering Drift Compensation Setting, Drive Response Setting.</p> <p>Other: Audible Alarm, Lights, Option / Accessory Switches.</p> <p>Optional Deluxe Instrumentation Panel:</p> <p>*Additional bar-type gauges for: Engine Oil Pressure, System Voltage, Hydrostatic Charge Pressure and Hydraulic Oil Temperature.</p> <p>*Additional Features Included: Keyless Start, Digital Clock, Job Clock, Attachment Control Information, Password Lockout, Multi-language Display, Help Screens, Diagnostic Capability and Engine / Hydraulic Systems Shutdown Function.</p>

Capacities

Fuel	45,2 L (11.9 U.S. gal)
Engine Lubrication and Filter	6,3 L (6.7 qt)
Engine Cooling System w/o Heater	11,0 L (11.6 qt)
Engine Cooling System w/ Heater	12,0 L (12.7 qt)
Hydraulic / Hydrostatic Reservoir	13,0 L (3.4 U.S. gal)
Hydraulic / Hydrostatic System	24,0 L (6.3 U.S. gal)

Tracks

Standard	250 mm (9.8 in) Rubber, C-Pattern
----------	-----------------------------------

Ground Pressure

	STANDARD CONTROLS	SELECTABLE JOYSTICK CONTROLS (SJC)
Standard track	0,0317 MPa (0,317 bar) (4.6 psi)	0,0331 MPa (0,331 bar) (4.8 psi)



(T110) LOADER SPECIFICATIONS (CONT'D)

Fuel Consumption

Engine Load	Full - 100%	High - 70%	Medium - 50%	Low - 30%
Fuel Consumption Rate Per Hour	7,6 L (2.0 U.S. gal)	5,7 L (1.5 U.S. gal)	4,9 L (1.3 U.S. gal)	4,5 L (1.2 U.S. gal)

NOTE: The engine fuel consumption chart is to be used as a guideline only. The actual results may vary.

Environmental

	Noise / Vibration Levels	Uncertainties (If Applicable)
Noise level LpA (EU Directive 2000/14/EC)	99 dB(A)	- - -
Operator position noise level (ISO 6396)	86,3 dB(A)	- - -
Whole body vibration (ISO 2631-1) (limit 0,5 m/s ²)	1,01 m/s ²	0,455 m/s ²
Hand-arm vibration (ISO 5349-1) (limit 2,5 m/s ²)	2,94 m/s ²	1,42 m/s ²

Temperature Range

Operation and storage	-26 - +38°C (-14.8 - +100.4°F)
-----------------------	--------------------------------



Bobcat®



WARRANTY

WARRANTY	173
WARRANTY	174



Bobcat®

WARRANTY

WARRANTY

BOBCAT LOADERS

DOOSAN BENELUX S.A. warrants to its authorised dealers who in turn warrant to the end-user / owner that each new Bobcat loader will be free from proven defects in material and workmanship for twelve months from the date of delivery to the end-user / owner or 2000 hours of machine usage, whichever occurs first.

During the warranty period, the authorised selling Bobcat dealer shall repair or replace, at DOOSAN BENELUX S.A.'s option, without charge for parts, labour and travel time of mechanics, any part of the Bobcat product which fails because of defects in material and workmanship. The end-user / owner shall provide the authorised Bobcat dealer with prompt written notice of the defect and allow reasonable time for replacement or repair. DOOSAN BENELUX S.A. may, at its option, request failed parts to be returned to the factory. Transportation of the Bobcat product to the authorised Bobcat dealer for warranty work is the responsibility of the end-user / owner.

Service schedules must be adhered to, documented and genuine parts / lubricants must be used. The warranty does not cover oils and lubricants, coolant fluids, filter elements, tune-up parts, bulbs, fuses, ignition system parts (glow plugs, fuel injection pumps, injectors), alternator fan belts, drive belts and other high-wear items. Pins and bushings are considered to be normal consumable items and are not warranted.

The warranty does not apply to tyres or other trade accessories not manufactured by Bobcat. The owner shall rely solely on the warranty, if any, of the respective manufacturers thereof. The warranty does not cover damages resulting from abuse, accidents, alterations, use of the Bobcat product with any bucket or attachment not approved by Bobcat, air flow obstructions, or failure to maintain or use the Bobcat product according to the instructions applicable to it.

DOOSAN BENELUX S.A. EXCLUDES OTHER CONDITIONS, WARRANTIES OR REPRESENTATIONS OF ALL KINDS, EXPRESSED OR IMPLIED, STATUTORY OR OTHERWISE (EXCEPT THAT OF TITLE) INCLUDING ALL IMPLIED WARRANTIES AND CONDITIONS RELATING TO MERCHANTABILITY, SATISFACTORY QUALITY AND FITNESS FOR A PARTICULAR PURPOSE.

CORRECTIONS BY DOOSAN BENELUX S.A. OF NONCONFORMITIES WHETHER PATENT OR LATENT, IN THE MANNER AND FOR THE TIME PERIOD PROVIDED ABOVE, SHALL CONSTITUTE FULFILMENT OF ALL LIABILITIES OF DOOSAN BENELUX S.A. FOR SUCH NONCONFORMITIES, WHETHER BASED ON CONTRACT, WARRANTY, TORT, NEGLIGENCE, INDEMNITY, STRICT LIABILITY OR OTHERWISE WITH RESPECT TO OR ARISING OUT OF SUCH PRODUCT.

THE REMEDIES OF THE END-USER / OWNER SET FORTH UNDER THE PROVISIONS OF THE WARRANTY OUTLINED ABOVE ARE EXCLUSIVE AND THE TOTAL LIABILITY OF DOOSAN BENELUX S.A. INCLUDING ANY HOLDING, SUBSIDIARY, ASSOCIATED OR AFFILIATED COMPANY OR DISTRIBUTOR WITH RESPECT TO THIS SALE OR THE PRODUCT AND SERVICE FURNISHED HEREUNDER IN CONNECTION WITH THE PERFORMANCE OR BREACH THEREOF, OR FROM DELIVERY, INSTALLATION, REPAIR OR TECHNICAL DIRECTION COVERED BY OR FURNISHED UNDER THIS SALE, WHETHER BASED ON CONTRACT, WARRANTY, TORT, NEGLIGENCE, INDEMNITY, STRICT LIABILITY OR OTHERWISE SHALL NOT EXCEED THE PURCHASE PRICE OF THE PRODUCT UPON WHICH SUCH LIABILITY IS BASED.

DOOSAN BENELUX S.A. INCLUDING ANY HOLDING, SUBSIDIARY, ASSOCIATED OR AFFILIATED COMPANY AND DISTRIBUTOR SHALL IN NO EVENT BE LIABLE TO THE END-USER / OWNER, ANY SUCCESSORS IN INTEREST OR ANY BENEFICIARY OR ASSIGNEE RELATING TO THIS SALE FOR ANY CONSEQUENTIAL, INCIDENTAL, INDIRECT, SPECIAL OR PUNITIVE DAMAGES ARISING OUT OF THIS SALE OR BY ANY BREACH THEREOF, OR ANY DEFECT IN, OR FAILURE OF, OR MALFUNCTION OF THE PRODUCT UNDER THIS SALE, WHETHER BASED UPON LOSS OF USE, LOST PROFITS OR REVENUE, INTEREST, LOST GOODWILL, WORK STOPPAGE, IMPAIRMENT OF OTHER GOODS, LOSS BY REASON OF SHUTDOWN OR NON-OPERATION, INCREASED EXPENSES OF OPERATION OR CLAIMS OF USER OR CUSTOMERS OF THE USER FOR SERVICE INTERRUPTION WHETHER OR NOT SUCH LOSS OR DAMAGE IS BASED ON CONTRACT, WARRANTY, TORT, NEGLIGENCE, INDEMNITY, STRICT LIABILITY OR OTHERWISE.





WARRANTY

WARRANTY

BOBCAT TRACK WARRANTY

Every new rubber track is warranted to be free of defects in material and workmanship for the life of the original tread design within the limits of the normal warranty conditions.

Original tread life is considered completed when the track has 10 percent or less of remaining tread in any position of its original tread depth, in any portion of its original tread design.

If upon presentation of the track to the authorised Bobcat representative, the representative determines the warranty claim is valid during the first 10 percent of tread life, DOOSAN BENELUX S.A. and the authorised dealer will supply a comparable new track at no charge. If the warranty claim is granted after the first 10 percent of tread life of the track has worn away, but before the original tread life is completed, the original buyer will receive a pro-rata replacement credit toward the purchase of a comparable new track, relative to the unused portion of the tread on the original track based on a predetermined schedule in effect at the time of replacement. The end-user/owner pays all applicable taxes and disposal costs relating to the replacement.

This warranty only applies when the track is installed on the approved recommended Bobcat product. This warranty does not cover track failures as a result of tears, cuts, fire or vandalism, damaged or broken cords due to improper adjustment, age conditions such as cracks, and extreme temperature exposure.

This warranty is solely for the benefit of the end-user/owner of the track and is not assignable.

DOOSAN BENELUX S.A. EXCLUDES OTHER CONDITIONS, WARRANTIES OR REPRESENTATIONS OF ALL KINDS, EXPRESSED OR IMPLIED, STATUTORY OR OTHERWISE (EXCEPT THAT OF TITLE) INCLUDING ALL IMPLIED WARRANTIES AND CONDITIONS RELATING TO MERCHANTABILITY, SATISFACTORY QUALITY AND FITNESS FOR A PARTICULAR PURPOSE.

CORRECTIONS BY DOOSAN BENELUX S.A. OF NONCONFORMITIES WHETHER PATENT OR LATENT, IN THE MANNER AND FOR THE TIME PERIOD PROVIDED ABOVE, SHALL CONSTITUTE FULFILMENT OF ALL LIABILITIES OF DOOSAN BENELUX S.A. FOR SUCH NONCONFORMITIES, WHETHER BASED ON CONTRACT, WARRANTY, TORT, NEGLIGENCE, INDEMNITY, STRICT LIABILITY OR OTHERWISE WITH RESPECT TO OR ARISING OUT OF SUCH PRODUCT.

THE REMEDIES OF THE END-USER/OWNER SET FORTH UNDER THE PROVISIONS OF THE WARRANTY OUTLINED ABOVE ARE EXCLUSIVE AND THE TOTAL LIABILITY OF DOOSAN BENELUX S.A. INCLUDING ANY HOLDING, SUBSIDIARY, ASSOCIATED OR AFFILIATED COMPANY OR DISTRIBUTOR WITH RESPECT TO THIS SALE OR THE PRODUCT AND SERVICE FURNISHED HEREUNDER IN CONNECTION WITH THE PERFORMANCE OR BREACH THEREOF, OR FROM DELIVERY, INSTALLATION, REPAIR OR TECHNICAL DIRECTION COVERED BY OR FURNISHED UNDER THIS SALE, WHETHER BASED ON CONTRACT, WARRANTY, TORT, NEGLIGENCE, INDEMNITY, STRICT LIABILITY OR OTHERWISE SHALL NOT EXCEED THE PURCHASE PRICE OF THE PRODUCT UPON WHICH SUCH LIABILITY IS BASED.

DOOSAN BENELUX S.A. INCLUDING ANY HOLDING, SUBSIDIARY, ASSOCIATED OR AFFILIATED COMPANY AND DISTRIBUTOR SHALL IN NO EVENT BE LIABLE TO THE END-USER/OWNER, ANY SUCCESSORS IN INTEREST OR ANY BENEFICIARY OR ASSIGNEE RELATING TO THIS SALE FOR ANY CONSEQUENTIAL, INCIDENTAL, INDIRECT, SPECIAL OR PUNITIVE DAMAGES ARISING OUT OF THIS SALE OR BY ANY BREACH THEREOF, OR ANY DEFECT IN, OR FAILURE OF, OR MALFUNCTION OF THE PRODUCT UNDER THIS SALE, WHETHER BASED UPON LOSS OF USE, LOST PROFITS OR REVENUE, INTEREST, LOST GOODWILL, WORK STOPPAGE, IMPAIRMENT OF OTHER GOODS, LOSS BY REASON OF SHUTDOWN OR NON-OPERATION, INCREASED EXPENSES OF OPERATION OR CLAIMS OF USER OR CUSTOMERS OF THE USER FOR SERVICE INTERRUPTION WHETHER OR NOT SUCH LOSS OR DAMAGE IS BASED ON CONTRACT, WARRANTY, TORT, NEGLIGENCE, INDEMNITY, STRICT LIABILITY OR OTHERWISE.

THIS WARRANTY IS IN LIEU OF ALL OTHER WARRANTIES (EXCEPT THOSE OF TITLE), EXPRESSED OR IMPLIED, AND THERE ARE NO WARRANTIES OF MERCHANTABILITY OR FITNESS FOR A PARTICULAR PURPOSE. IN NO EVENT SHALL THE AUTHORISED SELLING DEALER OR BOBCAT COMPANY BE LIABLE FOR DOWNTIME EXPENSES, LOSS OF MACHINE USE OR OTHER INCIDENTAL, CONSEQUENTIAL OR SPECIAL DAMAGES. THIS WARRANTY IS EXCLUSIVE AND IN LIEU OF ALL OTHER WARRANTIES AND CONDITIONS, EXCEPT THE WARRANTY OF TITLE. BOBCAT COMPANY DISCLAIMS ALL OTHER WARRANTIES AND CONDITIONS, EXPRESS OR IMPLIED, INCLUDING ANY IMPLIED WARRANTIES OR CONDITIONS OF MERCHANTABILITY OR FITNESS FOR A PARTICULAR PURPOSE. IN NO EVENT SHALL BOBCAT COMPANY OR THE AUTHORISED BOBCAT DEALER BE LIABLE FOR ANY SPECIAL, INCIDENTAL, INDIRECT OR CONSEQUENTIAL DAMAGES WHATSOEVER, INCLUDING, BUT NOT LIMITED TO, LOSS OR INTERRUPTION OF BUSINESS, LOST PROFITS, OR LOSS OF MACHINE USE, WHETHER BASED ON CONTRACT, WARRANTY, TORT, NEGLIGENCE, STRICT LIABILITY, STATUTE OR OTHERWISE, EVEN IF BOBCAT COMPANY OR THE AUTHORISED BOBCAT DEALER HAS BEEN ADVISED OF THE POSSIBILITY OF SUCH DAMAGES. THE TOTAL LIABILITY OF BOBCAT EUROPE AND THE AUTHORISED BOBCAT DEALERS WITH RESPECT TO THE PRODUCT AND SERVICES FURNISHED HEREUNDER SHALL NOT EXCEED THE PURCHASE PRICE OF THE PRODUCT UPON WHICH SUCH LIABILITY IS BASED.



4700008-EN (1-10)

Printed in Belgium



ALPHABETICAL INDEX

(T110) LOADER SPECIFICATIONS	165	MACHINE SIGNS (DECALS)	24
AIR CLEANER SERVICE	119	MAINTENANCE CLOCK	162
ALTERNATOR BELT	140	MAINTENANCE SAFETY	103
ATTACHMENT CONTROL DEVICE (ACD)	65	MONITORING THE DISPLAY PANELS	78
ATTACHMENTS	80	OPERATING PROCEDURE	88
BACK-UP ALARM SYSTEM	113	OPERATOR CAB	114
BACK-UP ALARM SYSTEM	47	OPERATOR SAFETY WARNINGS	1
BOBCAT COMPANY IS ISO 9001 CERTIFIED	9	PARKING BRAKE	45
BOBCAT INTERLOCK CONTROL SYSTEM (BICS™)	106	PASSWORD SETUP (DELUXE INSTRUMENTATION PANEL)	160
BOBCAT INTERLOCK CONTROL SYSTEM (BICS™)	44	PASSWORD SETUP (KEYLESS START PANEL)	159
BOB-TACH (HAND LEVER)	145	PIVOT PINS	144
BOB-TACH (POWER)	146	PRE-STARTING PROCEDURE	68
CONTROL IDENTIFICATION	41	PUBLICATIONS AND TRAINING RESOURCES	28
CONTROL PANEL SETUP	157	REAR DOOR (TAILGATE)	117
DAILY INSPECTION	66	REAR GRILLE	117
DECLARATION OF CONFORMITY	7	REGULAR MAINTENANCE ITEMS	9
DELIVERY REPORT	11	SAFETY INSTRUCTIONS	19
DIAGNOSTIC SERVICE CODES	151	SEAT BAR RESTRAINT SYSTEM	109
DRIVE BELT	141	SEAT BAR RESTRAINT SYSTEM	43
DRIVE RESPONSE	55	SEAT BELT	110
DRIVING AND STEERING THE LOADER	49	SERIAL NUMBER LOCATIONS	11
ELECTRICAL SYSTEM	128	SERVICE SCHEDULE	105
EMERGENCY EXIT	46	SPARK ARRESTER MUFFLER	136
ENGINE COOLING SYSTEM	126	SPEED MANAGEMENT	53
ENGINE LUBRICATION SYSTEM	124	STARTING THE ENGINE	71
ENGINE SPEED CONTROL	48	STEERING DRIFT COMPENSATION	57
FEATURES, ACCESSORIES AND ATTACHMENTS	13	STOPPING THE ENGINE AND LEAVING THE LOADER	79
FIRE PREVENTION	21	STOPPING THE LOADER	51
FUEL SYSTEM	121	TOWING THE LOADER	97
HEATING SYSTEM	118	TRACK ROLLER AND IDLER LUBRICATION	143
HYDRAULIC / HYDROSTATIC SYSTEM	132	TRACK SPROCKET MAINTENANCE	139
HYDRAULIC CONTROLS	59	TRACK TENSION	137
HYDROSTATIC DRIVE MOTOR	139	TRACK UNDERCARRIAGE SYSTEM	86
INSTRUMENT PANEL IDENTIFICATION	33	TRACTION LOCK OVERRIDE	45
LIFT ARM BYPASS CONTROL	45	TRANSPORTING THE LOADER ON A TRAILER	98
LIFT ARM SUPPORT DEVICE	111	TWO-SPEED CONTROL	52
LIFTING THE LOADER	97	WARRANTY	173
LOADER IDENTIFICATION	12	WARRANTY	174
LOADER STORAGE AND RETURN TO SERVICE	147		
LUBRICANTS AND FLUIDS	10		
LUBRICATING THE LOADER	142		



Bobcat®



